

PLAGES D'UTILISATION

Débits jusqu'à :	42 m³/h
Hauteurs mano. jusqu'à :	110 m
Température maxi de l'eau :	+50°C
Pression de service maxi :	16 bar
Température ambiante maxi :	+40°C
DN collecteurs filetés :	G1 1/2 - G2 - G3

HYDROPLUS - S

SURPRESSEURS

équipés de pompes **MULTi-VS**
Usages collectifs et industriels
2 pôles - 50 Hz

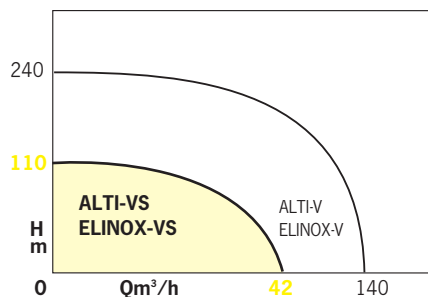

APPLICATIONS

Mise et maintien sous pression de réseaux de distribution d'eau à pression insuffisante ou inexistante, pour :

- ensembles d'habitations, de bureaux,
- résidences privées,

- hôtels, hôpitaux, cliniques,
- centres commerciaux, magasins,
- écoles, lycées, universités, casernes,
- protection incendie,
- irrigation, arrosage,
- bâtiments industriels, agricoles...



• Coffret variation de vitesse



• Coffret électronique, 2 pompes



• Elinox-VS 3 pompes, coffret électronique

motralec

4 rue Lavoisier . ZA Lavoisier . 95223 HERBLAY CEDEX

Tel. : 01.39.97.65.10 / Fax. : 01.39.97.68.48

Demande de prix / e-mail : service-commercial@motralec.com

www.motralec.com

Salmson

HYDROPLUS - S

AVANTAGES

- Modules très silencieux : de 38 à 58 dB(A).
- Modules compacts, préréglés en usine et prêts à être installés.
- Encombrement au sol très réduit.
- Installation facile : 2 raccordements hydrauliques et un branchement électrique.
- Commande et protection regroupées dans l'armoire qui assure l'automatisme intégral de fonctionnement.
- Collecteurs aspiration-refoulement en fonte galvanisée ou en inox.
- Ensemble hydraulique en acier inox : sécurité anti-corrosion et durée de vie accrue.
- Maintenance facilitée par l'absence de garniture mécanique.

CONCEPTION

ALTI-VS, ELINOX-VS

Surpresseurs compacts, particulièrement étudiés pour les systèmes de surpression directe ou classique, en charge, équipés de :

- Deux ou trois pompes verticales multicellulaires à rotor noyé, MULTI-VS, dont les caractéristiques hydrauliques sont prédéterminées.
- Deux collecteurs aspiration-refoulement en inox ou en fonte galvanisée ; choix des raccordements à droite ou à gauche.
- Vannes au refoulement et à l'aspiration de chaque pompe.
- Clapet anti-retour silencieux au refoulement de chaque pompe.
- Un pressostat de commande automatique des pompes, (CM-CE).
- Un transmetteur de pression (CV).
- Un pressostat manque d'eau (version réseau eau de ville).
- Un interrupteur à flotteur pour le manque

d'eau (version pour bache de stockage).

- Un manomètre.
- Un châssis de support et de fixation.
- Des anneaux de levage.
- Un coffret de régulation existant sous trois configurations :

CM : électromécanique
CE : électronique
CV : variation de vitesse.

Les modules sont précâblés, peints et prêts à être installés.

L'alimentation en eau du surpresseur est possible à partir d'un réseau de ville ou d'une bache de stockage, en charge.

OPTION : surpresseurs 4 pompes et plus, pompes jockey, ...

IDENTIFICATION DU SURPRESSEUR

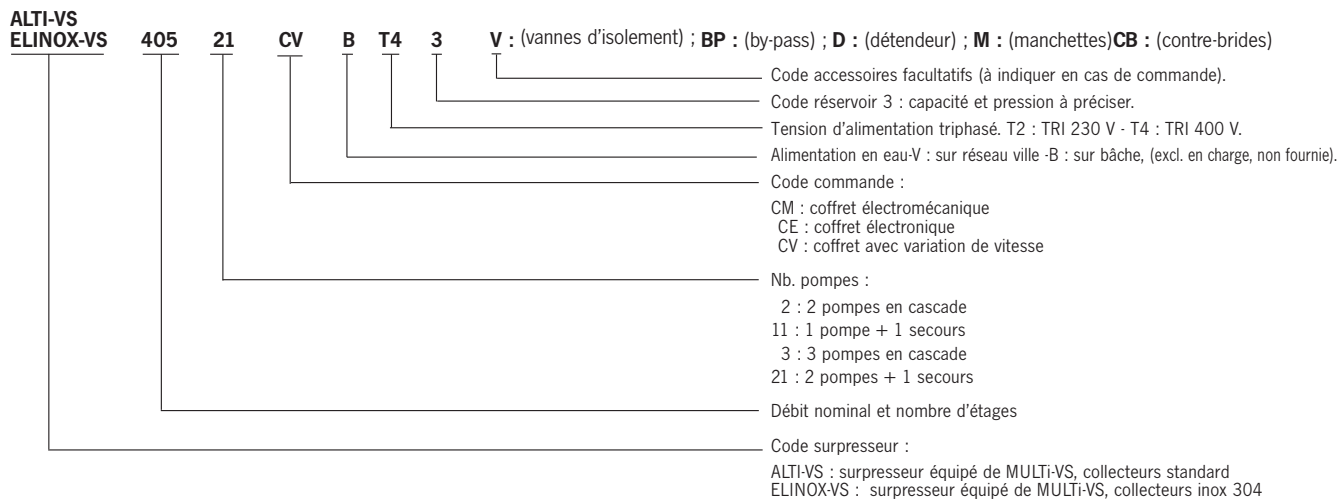

LA GAMME

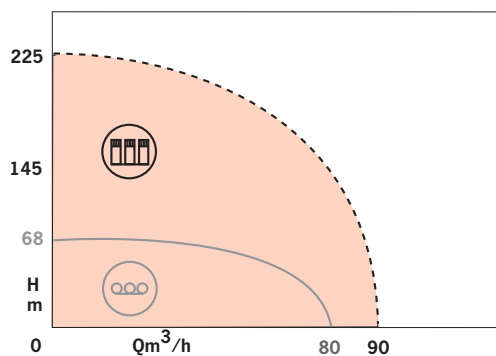
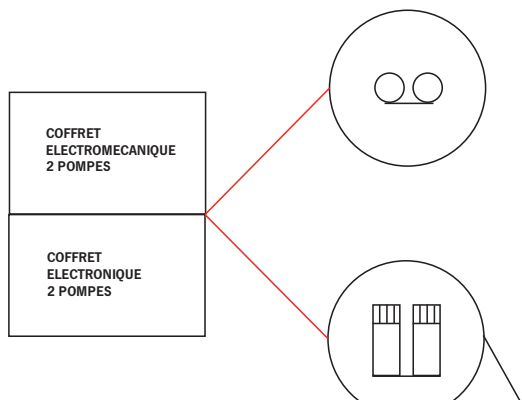

CONSTRUCTION DE BASE ET FOURNITURES

COMPOSANTS		ALTI-VS		ELINOX-VS	
		2 pompes	3 pompes	2 pompes	3 pompes
Collecteurs	Fonte galvanisée	•	•		
	Inox 304			•	•
Vannes Clapets anti-retour	Laiton	•	•		
	Inox 316			•	•
Pressostats :	CE simple	•		•	
	CM à plage neutre		•		•
	CM à plage neutre	•	•	•	•

Pièces principales Pompe	Matériau
Roues	Inox 304
Corps d'étage	Inox 304
Chemise	Inox 304
Arbre pompe	Inox 304
Chemise d'entrefer	Inox 304
Coussinets	Graphite
Joints de corps	EPDM

Normes et spécifications :
 Directive "machines" 89/392/CEE ; Directive "compatibilité électromagnétique" 89/336/CEE.
 Electriques : NFC 15-100 / EN809 / EN50.081-1 & 2.
 Distribution eau potable : Guide Technique n°1-B.O..87-14bis, DTU 60-1.
 Matériaux : NFA 91-121

Exemples avec surpresseur 3 pompes. Mêmes représentations avec un surpresseur 2 pompes.

VERSION "V"

A PARTIR DU RESEAU DE VILLE
(en charge)

VERSION "B"

A PARTIR D'UNE BÂCHE DE STOCKAGE
(en charge)

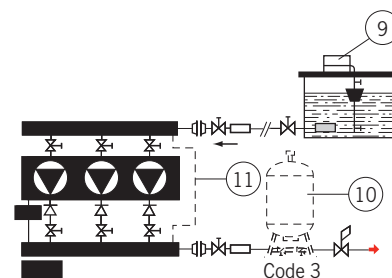
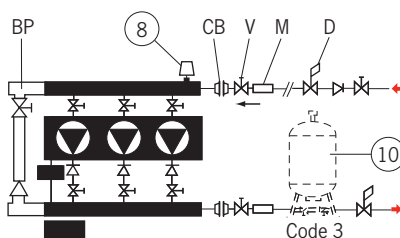
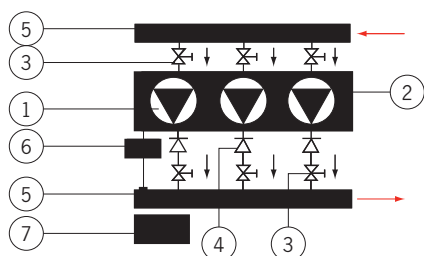

FOURNITURES STANDARD (1 à 9)

- 1 – Deux ou trois pompes multicellulaires.
- 2 – Châssis support.
- 3 – Vannes d'isolement à l'aspiration et au refoulement des pompes.
- 4 – Clapets anti-retour au refoulement des pompes.
- 5 – Collecteurs aspiration-refoulement.
- 6 – Pressostat de commande pompes.
- 7 – Armoire de régulation et de protection.

FOURNITURES OBLIGATOIRES :

(selon l'alimentation en eau du surpresseur).

- 8 – Pressostat de protection manque d'eau, livré monté, surpresseur alimenté sur eau de ville (inclus dans le prix).
ou
- 9 – Interrupteur à flotteur, livré non monté, surpresseur alimenté sur bache en charge (inclus dans le prix).
- 10 – Réservoir à vessie CODE 3 100 à 2000 litres, préciser pression de service et capacité (option en supplément de prix).

FOURNITURES FACULTATIVES :

(options en supplément de prix).

- BP – By-pass d'alimentation directe en eau, lorsque la pression du réseau de ville est suffisante (livré monté en cas de commande).
- M – Manchettes anti-vibratoires (fournies par 2).
- CB – Contre-bridés à visser ou à souder sur collecteurs (fournies par 2).
- D – Détendeur-stabilisateur de pression sur aspiration et/ou refoulement.
- V – Vannes d'isolement.

Remarque : dans le cas où un by-pass et un détendeur à l'aspiration sont installés sur le surpresseur, il est recommandé de monter le détendeur entre le by-pass et le surpresseur.

PERFORMANCES HYDRAULIQUES ALTI-VS/ELINOX-VS - 2900 TR/MN - SERIES 200 ET 400

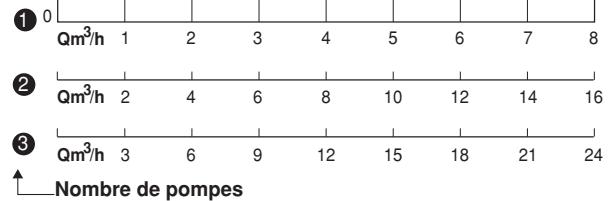
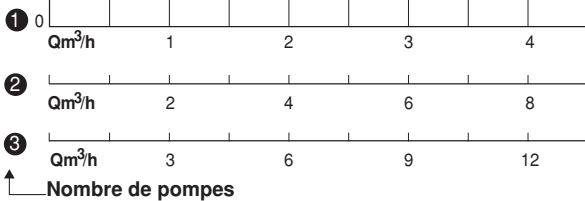
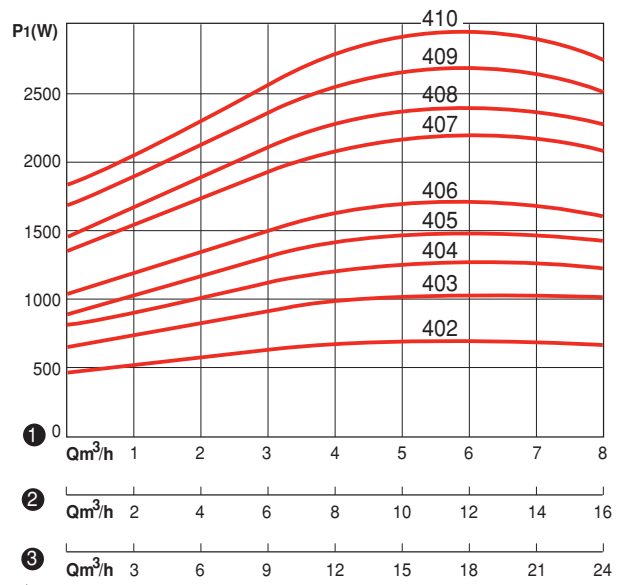
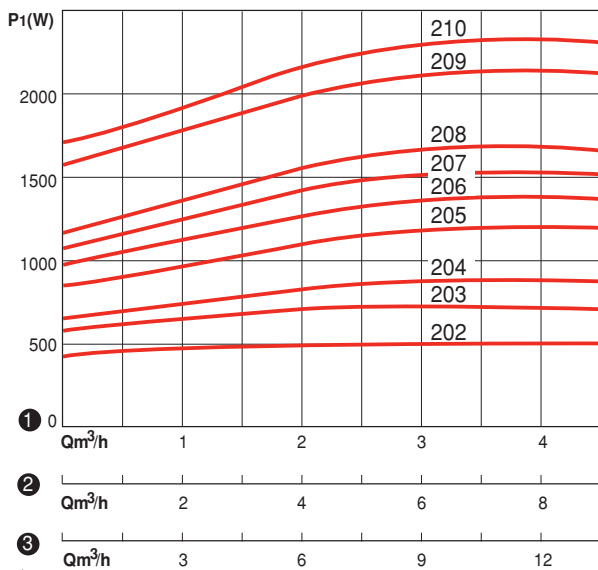
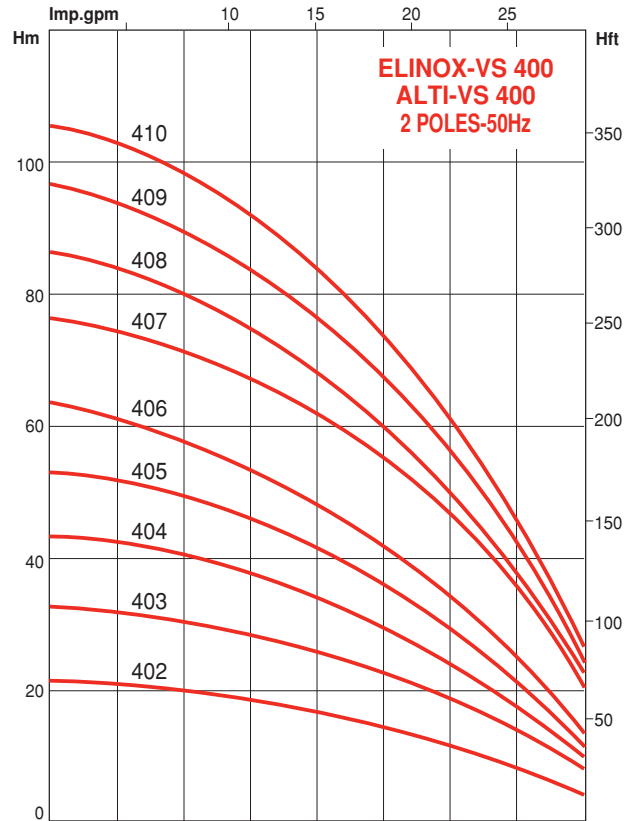
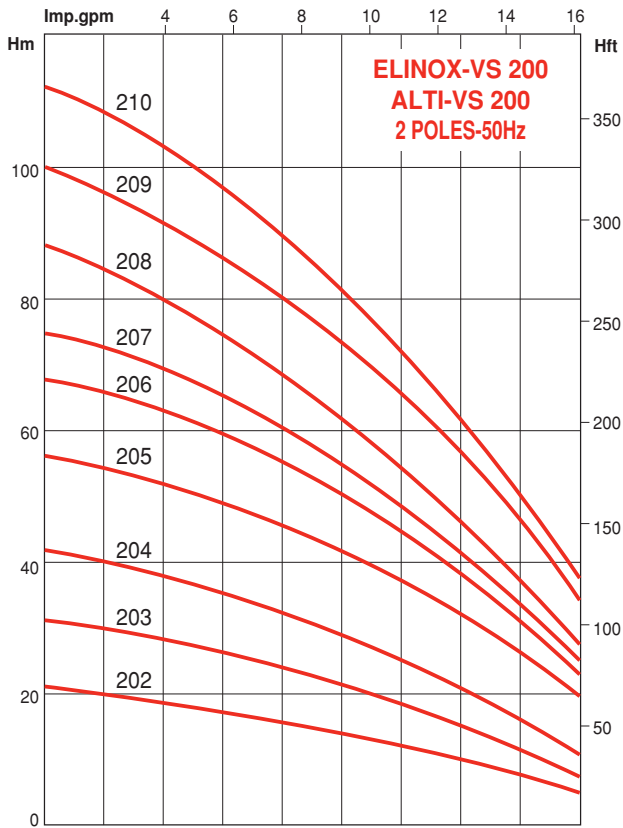

P. HYDRAULIQUES SERIE 800

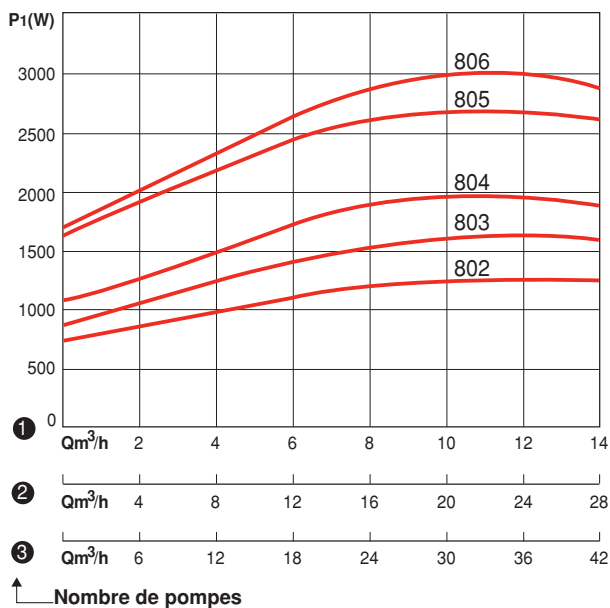
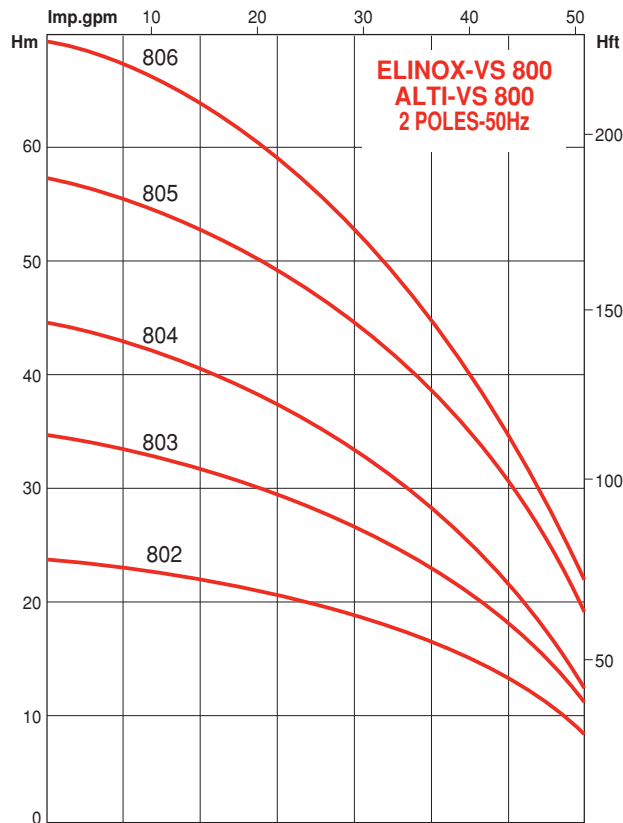

CARACTERISTIQUES ELECTRIQUES

Nom du surpresseur -2 ou 3 (pompes)	Puissance moteur P1 en kW	Intensité totale en A sous Tri 230	Intensité totale en A sous Tri 400
Elinox-VS-202 Alti-VS-202	2 ou 3 x 0,51	2 ou 3 x 2,1	2 ou 3 x 1,2
Elinox-VS-203 Alti-VS-203	2 ou 3 x 0,72	2 ou 3 x 2,6	2 ou 3 x 1,5
Elinox-VS-204 Alti-VS-204	2 ou 3 x 0,88	2 ou 3 x 3	2 ou 3 x 1,7
Elinox-VS-205 Alti-VS-205	2 ou 3 x 1,2	2 ou 3 x 4,5	2 ou 3 x 2,6
Elinox-VS-206 Alti-VS-206	2 ou 3 x 1,38	2 ou 3 x 4,9	2 ou 3 x 2,8
Elinox-VS-207 Alti-VS-207	2 ou 3 x 1,53	2 ou 3 x 5,2	2 ou 3 x 3
Elinox-VS-208 Alti-VS-208	2 ou 3 x 1,69	2 ou 3 x 5,6	2 ou 3 x 3,2
Elinox-VS-209 Alti-VS-209	2 ou 3 x 2,14	2 ou 3 x 8	2 ou 3 x 4,6
Elinox-VS-210 Alti-VS-210	2 ou 3 x 2,33	2 ou 3 x 8,5	2 ou 3 x 4,9
Elinox-VS-402 Alti-VS-402	2 ou 3 x 0,69	2 ou 3 x 2,6	2 ou 3 x 1,5
Elinox-VS-403 Alti-VS-403	2 ou 3 x 1,02	2 ou 3 x 4,2	2 ou 3 x 2,4
Elinox-VS-404 Alti-VS-404	2 ou 3 x 1,26	2 ou 3 x 4,5	2 ou 3 x 2,6
Elinox-VS-405 Alti-VS-405	2 ou 3 x 1,48	2 ou 3 x 5,2	2 ou 3 x 3
Elinox-VS-406 Alti-VS-406	2 ou 3 x 1,7	2 ou 3 x 5,6	2 ou 3 x 3,2
Elinox-VS-407 Alti-VS-407	2 ou 3 x 2,2	2 ou 3 x 8	2 ou 3 x 4,6
Elinox-VS-408 Alti-VS-408	2 ou 3 x 2,4	2 ou 3 x 8,5	2 ou 3 x 4,9
Elinox-VS-409 Alti-VS-409	2 ou 3 x 2,69	2 ou 3 x 9,2	2 ou 3 x 5,3
Elinox-VS-410 Alti-VS-410	2 ou 3 x 2,94	2 ou 3 x 9,7	2 ou 3 x 5,6
Elinox-VS-802 Alti-VS-802	2 ou 3 x 1,25	2 ou 3 x 4,5	2 ou 3 x 2,6
Elinox-VS-803 Alti-VS-803	2 ou 3 x 1,6	2 ou 3 x 5,4	2 ou 3 x 3,1
Elinox-VS-804 Alti-VS-804	2 ou 3 x 1,95	2 ou 3 x 6,3	2 ou 3 x 3,6
Elinox-VS-805 Alti-VS-805	2 ou 3 x 2,67	2 ou 3 x 9,2	2 ou 3 x 5,3
Elinox-VS-806 Alti-VS-806	2 ou 3 x 2,98	2 ou 3 x 9,7	2 ou 3 x 5,6

ELINOX-VS / ALTI-VS : CARACTERISTIQUES DIMENSIONNELLES

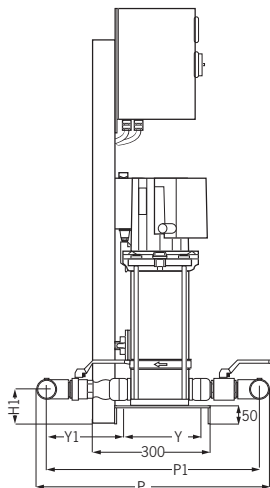
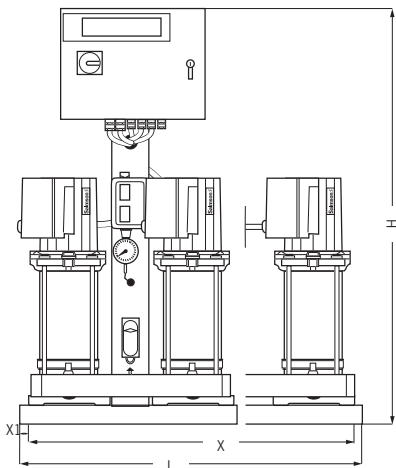

ELINOX-VS, ALTI-VS
(2 et 3 pompes)
coffret électromécanique
(CM)

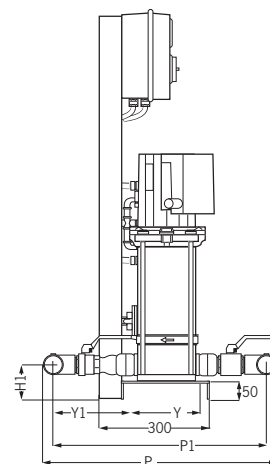
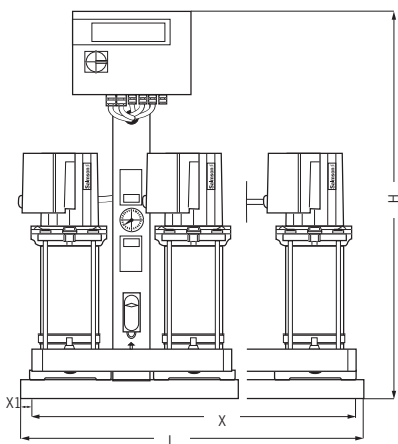

ELINOX-VS, ALTI-VS
(2 et 3 pompes)
coffret électronique
(CE)

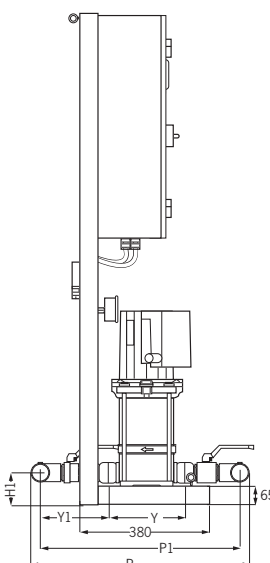
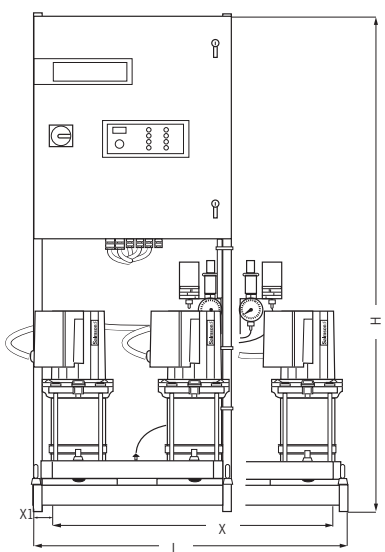

ELINOX-VS, ALTI-VS
(2 et 3 pompes)
coffret variation
de vitesse
(CV)

Nom du surpresseur -2 ou 3	DN collecteurs filetés	
Elinox-VS-202 Alti-VS-202	1 1/2"	
Elinox-VS-203 Alti-VS-203		
Elinox-VS-204 Alti-VS-204		
Elinox-VS-205 Alti-VS-205		
Elinox-VS-206 Alti-VS-206		
Elinox-VS-207 Alti-VS-207		
Elinox-VS-208 Alti-VS-208		
Elinox-VS-209 Alti-VS-209		
Elinox-VS-210 Alti-VS-210		
Elinox-VS-402 Alti-VS-402		2"
Elinox-VS-403 Alti-VS-403		
Elinox-VS-404 Alti-VS-404		
Elinox-VS-405 Alti-VS-405		
Elinox-VS-406 Alti-VS-406		
Elinox-VS-407 Alti-VS-407		
Elinox-VS-408 Alti-VS-408	3"	
Elinox-VS-409 Alti-VS-409		
Elinox-VS-410 Alti-VS-410		
Elinox-VS-802 Alti-VS-802		
Elinox-VS-803 Alti-VS-803		
Elinox-VS-804 Alti-VS-804		
Elinox-VS-805 Alti-VS-805		
Elinox-VS-806 Alti-VS-806		

ELINOX-VS / ALTI-VS : CARACTERISTIQUES DIMENSIONNELLES

ELINOX-VS, ALTI-VS - 2 POMPES - CM, CE et CV

Référence 2 pompes	H mm			L mm			P mm			H1 mm			P1 mm			X mm			Y mm			X1 mm			Y1 mm		
	CM	CE	CV	CM	CE	CV	CM	CE	CV	CM	CE	CV	CM	CE	CV	CM	CE	CV	CM	CE	CV	CM	CE	CV	CM	CE	CV
Alti-VS-202																											
Alti-VS-203																											
Alti-VS-204																											
Alti-VS-205																											
Alti-VS-206								555					494												169		
Alti-VS-207																											
Alti-VS-208																											
Alti-VS-209																											
Alti-VS-210																											
Alti-VS-402																											
Alti-VS-403																											
Alti-VS-404																											
Alti-VS-405																											
Alti-VS-406	1183	1082	1670	600			605		100	115		534		540	490		220	260		30	55		193	173			
Alti-VS-407																											
Alti-VS-408																											
Alti-VS-409																											
Alti-VS-410																											
Alti-VS-802																									256	236	
Alti-VS-803																											
Alti-VS-804							775		130	145		672															
Alti-VS-805																											
Alti-VS-806																											
Elinox-VS-202																											
Elinox-VS-203																											
Elinox-VS-204																											
Elinox-VS-205																											
Elinox-VS-206							655					594													236		
Elinox-VS-207																											
Elinox-VS-208																											
Elinox-VS-209																											
Elinox-VS-210																											
Elinox-VS-402																											
Elinox-VS-403																											
Elinox-VS-404																											
Elinox-VS-405																											
Elinox-VS-406	1183	1082	1670	600			705		100	115		634		540	490		220	260		30	55		265	245			
Elinox-VS-407																											
Elinox-VS-408																											
Elinox-VS-409																											
Elinox-VS-410																											
Elinox-VS-802																											
Elinox-VS-803																											
Elinox-VS-804							875		130	145		772													336	316	
Elinox-VS-805																											
Elinox-VS-806																											

HYDROPLUS - S

ELINOX-VS / ALTI-VS : CARACTERISTIQUES DIMENSIONNELLES

ELINOX-VS, ALTI-VS -3 POMPES - CM, CE et CV

Référence 3 pompes	H mm			L mm			P mm			H1 mm			P1 mm			X mm			Y mm			X1 mm			Y1 mm																			
	CM	CE	CV	CM	CE	CV	CM	CE	CV	CM	CE	CV	CM	CE	CV	CM	CE	CV	CM	CE	CV	CM	CE	CV	CM	CE	CV																	
Alti-VS-202	1383	1157	1670	940	605	100	115	534	880	830	220	260	30	55	193	173	555	494	169	149	1383	1157	1670	940	605	100	115	534	880	830	220	260	30	55	193	173								
Alti-VS-203																																												
Alti-VS-204																																												
Alti-VS-205																																												
Alti-VS-206																																												
Alti-VS-207																																												
Alti-VS-208																																												
Alti-VS-209																																												
Alti-VS-210																																												
Alti-VS-402																																												
Alti-VS-403																																												
Alti-VS-404																																												
Alti-VS-405																																												
Alti-VS-406																																												
Alti-VS-407																																												
Alti-VS-408																																												
Alti-VS-409																																												
Alti-VS-410																																												
Alti-VS-802	1383	1157	1670	940	705	100	115	634	880	830	220	260	30	55	265	245	775	130	145	672	880	830	220	260	30	55	256	236	1383	1157	1670	940	705	100	115	634	880	830	220	260	30	55	265	245
Alti-VS-803																																												
Alti-VS-804																																												
Alti-VS-805																																												
Alti-VS-806																																												
Elinox-VS-202																																												
Elinox-VS-203																																												
Elinox-VS-204																																												
Elinox-VS-205																																												
Elinox-VS-206																																												
Elinox-VS-207																																												
Elinox-VS-208																																												
Elinox-VS-209																																												
Elinox-VS-210																																												
Elinox-VS-402																																												
Elinox-VS-403																																												
Elinox-VS-404																																												
Elinox-VS-405																																												
Elinox-VS-406																																												
Elinox-VS-407																																												
Elinox-VS-408																																												
Elinox-VS-409																																												
Elinox-VS-410																																												
Elinox-VS-802	1383	1157	1670	940	875	130	145	772	880	830	220	260	30	55	336	316	655	594	236	216	1383	1157	1670	940	875	130	145	772	880	830	220	260	30	55	336	316								
Elinox-VS-803																																												
Elinox-VS-804																																												
Elinox-VS-805																																												
Elinox-VS-806																																												
Elinox-VS-202																																												
Elinox-VS-203																																												
Elinox-VS-204																																												
Elinox-VS-205																																												
Elinox-VS-206																																												
Elinox-VS-207																																												
Elinox-VS-208																																												
Elinox-VS-209																																												
Elinox-VS-210																																												
Elinox-VS-402																																												
Elinox-VS-403																																												
Elinox-VS-404																																												
Elinox-VS-405																																												
Elinox-VS-406																																												
Elinox-VS-407																																												
Elinox-VS-408																																												
Elinox-VS-409																																												
Elinox-VS-410																																												