



10"

SAER®

ELETTROPOMPE

6NR-250

A-B-C



ELETTROPOMPE SOMMERSE 10" RADIALI

RADIAL SUBMERSIBLE ELECTRIC PUMPS 10"

ELECTROBOMBAS SUMERGIBLES RADIALES 10"

ITALIANO

IMPIEGHI

Idonea per il sollevamento, la pressurizzazione e distribuzione in impianti civili ed industriali, alimentazione di autoclavi e cisterne, impianti di lavaggio, sistemi di irrigazione, con prelievo da pozzi con diametro minimo 274 mm, vasche o bacini naturali.

CARATTERISTICHE COSTRUTTIVE

6NR-250: gruppo elettropompa completo con motore a bagno d'acqua 8" MS201 (fino a 92 kW) o 10" MS251 (a partire da 110 kW).

RP-250: parte idraulica accoppiabile a motori sommersi 8" con attacco secondo NEMA 18.414-18.424 o motori sommersi 10" (per l'accoppiamento, fare riferimento alla documentazione specifica per motori sommersi).

Giranti radiali.

Bocca di mandata completa di valvola di ritegno.

Controspinta: pompa dotata di anello di controspinta in resina anti-usura.

Bussola di guida in gomma anti-usura con camicia metallica.

Componenti realizzati con materiali particolari che assicurano una forte resistenza all'usura.

MATERIALI VERSIONI STANDARD

Giranti: ottone.

Diffusori: ghisa EN-GJL-250.

Albero in acciaio inossidabile AISI431, a profilo scanalato.

Bocca di mandata e supporto di aspirazione: ghisa ENGJS-500/7.

Mantello esterno in acciaio al carbonio Fe510 rivestito.

Dimensioni e tipologia bocche di mandata: versione con bocca flangiata.

DATI CARATTERISTICI

Fluido: chimicamente e meccanicamente non aggressivo, privo di corpi solidi o particelle abrasive.

Passaggio corpi solidi: max 3 mm, granulometria max 50 g/m³

Temperatura del liquido pompato: max 30°C (oltre, chiedere informazioni).

Pressione massima di esercizio: 95 bar.

Profondità massima di immersione: 300 m

Senso di rotazione: orario, osservando dalla bocca di mandata.

Prestazioni a 3600 1/min

6NR-250 A Qmax: 110 m³/h / Hmax: 885 m

6NR-250 B Qmax: 180 m³/h / Hmax: 522 m

6NR-250 C Qmax: 230 m³/h / Hmax: 409 m

TOLLERANZE PRESTAZIONI

Pompe: UNI EN ISO 9906 Appendice A, a richiesta Livello 1.

Motore: norme IEC 60034-1.

INSTALLAZIONE

Verticale / orizzontale in funzione della potenza.

VERSIONI SPECIALI

Tensioni diverse.

ACCESSORI A RICHIESTA

Quadro elettrico

Giunzione per cavo di alimentazione

ENGLISH

APPLICATION

Suitable for lifting, pressurising and distribution in civil and industrial installations, autoclave and cistern inlets, washing plants, irrigation systems. Draws from wells of min. diameter of 274 mm, tanks or natural basins.

CONSTRUCTION FEATURES

6NR-250: complete unit of pump with 8" water filled electric motor MS201 series (up to 92 kW) or 10" water filled electric motor MS251 series (starting from 110 kW).

RP-250: hydraulic part to be connected with 8" submersible motors with coupling following NEMA 18.414-18.424 or 10" submersible motors (For coupling, please refer to the specific documentation for the submersible motors).

Radial impellers.

Outlet complete with non return valve.

Pump equipped with counter trust ring in anti-rust resin.

Driving bushings in anti-wear rubber with metallic shell.

Components realized with particular materials which assure an high wear resistance.

MATERIALS - STANDARD VERSION

Impellers: brass.

Diffusers: cast iron EN-GJL-250.

Shaft in AISI431 stainless steel, with grooved profile.

Outlet and suction support: EN-GJS-500/7.

External shell: epoxy coated carbon steel Fe510.

Dimensions and type of outlet: flanged outlet.

OPERATION DATA

Fluid: chemically and mechanically non-aggressive, without any solid substance or abrasive parts.

Passing of solids: max 3 mm, maximum solid substance content 50 g/m³.

Temperature of the pumped liquid: max 30°C (for higher temperature, please, verify).

Maximum working pressure: 95 bar.

Maximum immersion depth: 300 m under liquid level.

Direction of rotation: clockwise, looking by the outlet.

Performance at 3600 rpm

6NR-250 A Qmax: 110 m³/h / Hmax: 885 m

6NR-250 B Qmax: 180 m³/h / Hmax: 522 m

6NR-250 C Qmax: 230 m³/h / Hmax: 409 m

PERFORMANCE TOLLERANCES

Pumps: UNI EN ISO 9906 Appendix A, Level 1 on request.

Motor: norms IEC 60034-1.

INSTALLATION

Vertical / horizontal as a function of power.

SPECIAL VERSIONS

Different tensions.

ACCESSORIES ON REQUEST

Control panel

Cable Joint

ESPAÑOL

APLICACIONES

Adecuada para la elevación, pressurización y distribución en instalaciones de tipo civil e industrial, distribución a autoclaves y cisternas, sistemas de lavado, sistemas de riego, con trasiego de pozos con diametro min.274 mm, tanques y cuencas.

CARACTERISTICAS DE CONSTRUCCION

6NR-250: grupo electrobomba completo con motor en bano de agua 8" serie MS201 (asta 92 kW) o 10" serie MS251 (a partir de 110 kW).

RP-250: parte hidraulica para ensamblaje con motores sumergidos 8" con ataque segun NEMA MG1-18.414-18.424 o con motores sumergidos 10" (para el acoplamiento, hacer referencia a la documentacion especifica para motores sumergidos).

Impulsores radiales.

Boca de descarga completa con valvola de retencion.

Bomba equipada con anillo de contra-empuje en resina antidesgaste.

Casquillos pilotos en goma anti-desgaste con camisa metallica.

Componentes realizados con materiales especiales anti-desgaste.

MATERIALES - EJECUCIONES ESTANDAR

Impulsores: laton.

Difusores: fundición gris EN-GJL-250.

Eje en acero inoxidable AISI431, con perfil en ranura.

Boca de descarga y soporte de aspiración: fundición gris ENGJS-500/7.

Faldon exterior: acero Fe510, revistio.

Dimensiones y tipo bocas de descarga: boca de salida.

DATOS DE FUNCIONAMIENTO

Fluido: quimicamente y mecanicamente no agresivo, sin cuerpos solidos o particulas abrasivas.

Pasaje cuerpos solidos: max 3 mm, contenido máximo de particulas sólidas 50 g/m³.

Temperatura del liquido bombeado: max 30°C (para valores superiores consultar verificación).

Presion de funcionamiento maxima: 95 bar.

Profundidad de sumersion maxima: 300 m.

Sentido de rotacion: orario, observando desde la boca de descarga.

Prestaciones en 3600 1/min

6NR-250 A Qmax: 110 m³/h / Hmax: 885 m

6NR-250 B Qmax: 180 m³/h / Hmax: 522 m

6NR-250 C Qmax: 230 m³/h / Hmax: 409 m

TOLERANCIAS PRESTACIONES

Bombas: UNI EN ISO 9906 Parrafo A, Nivel 1 bajo demanda.

Motor: normas IEC 60034-1.

INSTALACION

Vertical / horizontal segun potencia.

EJECUCIONES ESPECIALES

Varias tensiones.

ACCESORIOS BAJO DEMANDA

Quadro electrico

Empalme por cable



SAER®

ELETTROPOMPE

10"

COMPONENTI PRINCIPALI
MAIN COMPONENTS
COMPONENTES PRINCIPALES

6NR-250

A-B-C

COMPONENTE COMPONENT • COMPONENTE	VERSIONE VERSION • VERSIÓN
	NR250
Albero e giunto Shaft and coupling Eje y manguito	Acciaio inox Stainless steel AISI431 (1.4057) Acero inox
Girante Impeller Impulsor	Ottone Brass Latón
Diffusore Diffuser Difusor	Ghisa Cast iron EN-GJL-250 Fundición gris
Supporto aspirazione Suction support Soporte de aspiración	Ghisa Cast iron ENGJS-500/7 Fundición gris
Bocca di mandata Outlet Orificio de impulsión	Ghisa Cast iron ENGJS-500/7 Fundición gris
Tubo Pump pipe Tubo bomba	Acciaio Steel Fe510 Acero
Copricavo Cable cover Cubrecable	Acciaio inox Stainless steel AISI304 (1.4301) Acero inox
Parti in gomma Rubber components Partes en goma	Gomma Rubber EPDM Goma
Valvola Valve Valvula	Acciaio inox Stainless steel AISI316 (1.4301) Acero inox
Motore Motor Motor	MS201 – MS251

Elenco completo dei componenti a pag. 164 • Complete list of the components on page 164 • Lista completa de los componentes a la página 164

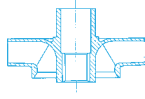

10"

SAER®
ELETTROPOMPE
6NR-250
A-B-C

TABELLA DELLE CARATTERISTICHE IDRAULICHE
TABLE OF THE HYDRAULIC FEATURES
TABLA DE LAS CARACTERISTICAS HIDRAULICAS
3600 l/min

Tipo Type	Motore Motor		S.F.	I _{sf} (A) 3~		Q	U.S.g.p.m.																										
	kW	HP		380V	460V		0																										
							m³/h																										
							0																										
							l/min																										
							0	176	220	264	308	352	396	440	484	0	40	50	60	70	80	90	100	110	0	667	833	1000	1167	1333	1500	1667	1833
6NR-250 A/2A *	26	35	1,15	66,5	54,7	H (m)	118	109	106	101	93	86	74	65	50	118	109	106	101	93	86	74	65	50	118	109	106	101	93	86	74	65	50
6NR-250 A/2 *	30	40	1,15	74,5	61,5		122	114	110	106	98	90	81	68	54	122	114	110	106	98	90	81	68	54	122	114	110	106	98	90	81	68	54
6NR-250 A/3A *	37	50	1,15	91	75		177	163,5	159	151,5	139,5	129	111	97,5	75	177	163,5	159	151,5	139,5	129	111	97,5	75	177	163,5	159	151,5	139,5	129	111	97,5	75
6NR-250 A/3 *	45	60	1,15	108	89		183	171	165	159	147	135	121,5	102	81	183	171	165	159	147	135	121,5	102	81	183	171	165	159	147	135	121,5	102	81
6NR-250 A/4A *	52	70	1,15	120	99		236	218	212	202	186	172	148	130	100	236	218	212	202	186	172	148	130	100	236	218	212	202	186	172	148	130	100
6NR-250 A/4 *	55	75	1,15	126	104		244	228	220	212	196	180	162	136	108	244	228	220	212	196	180	162	136	108	244	228	220	212	196	180	162	136	108
6NR-250 A/5A *	60	80	1,15	139	115		295	272,5	265	252,5	232,5	215	185	162,5	125	295	272,5	265	252,5	232,5	215	185	162,5	125	295	272,5	265	252,5	232,5	215	185	162,5	125
6NR-250 A/5 *	67	90	1,15	160	132		305	285	275	265	245	225	202,5	170	135	305	285	275	265	245	225	202,5	170	135	305	285	275	265	245	225	202,5	170	135
6NR-250 A/6A *	75	100	1,15	174	143		354	327	318	303	279	258	222	195	150	354	327	318	303	279	258	222	195	150	354	327	318	303	279	258	222	195	150
6NR-250 A/6 *	83	113	1,15	194	160		366	342	330	318	294	270	243	204	162	366	342	330	318	294	270	243	204	162	366	342	330	318	294	270	243	204	162
6NR-250 A/7A *	92	125	1,15	208	172		413	381,5	371	353,5	325,5	301	259	227,5	175	413	381,5	371	353,5	325,5	301	259	227,5	175	413	381,5	371	353,5	325,5	301	259	227,5	175
6NR-250 A/7 *	92	125	1,15	208	172		427	399	385	371	343	315	283,5	238	189	427	399	385	371	343	315	283,5	238	189	427	399	385	371	343	315	283,5	238	189
6NR-250 A/8A *	110	150	1,15	247	204		472	436	424	404	372	344	296	260	200	472	436	424	404	372	344	296	260	200	472	436	424	404	372	344	296	260	200
6NR-250 A/8 *	110	150	1,15	247	204		488	456	440	424	392	360	324	272	216	488	456	440	424	392	360	324	272	216	488	456	440	424	392	360	324	272	216
6NR-250 A/9A *	110	150	1,15	247	204		531	490,5	477	454,5	418,5	387	333	292,5	225	531	490,5	477	454,5	418,5	387	333	292,5	225	531	490,5	477	454,5	418,5	387	333	292,5	225
6NR-250 A/9	132	180	1,15	296	245		549	513	495	477	441	405	364,5	306	243	549	513	495	477	441	405	364,5	306	243	549	513	495	477	441	405	364,5	306	243
6NR-250 A/10A	132	180	1,15	296	245		590	545	530	505	465	430	370	325	250	590	545	530	505	465	430	370	325	250	590	545	530	505	465	430	370	325	250
6NR-250 A/10	132	180	1,15	296	245		610	570	550	530	490	450	405	340	270	610	570	550	530	490	450	405	340	270	610	570	550	530	490	450	405	340	270
6NR-250 A/11A	132	180	1,15	296	245		649	599,5	583	555,5	511,5	473	407	357,5	275	649	599,5	583	555,5	511,5	473	407	357,5	275	649	599,5	583	555,5	511,5	473	407	357,5	275
6NR-250 A/11	150	200	1,15	329	272		671	627	605	583	539	495	445,5	374	297	671	627	605	583	539	495	445,5	374	297	671	627	605	583	539	495	445,5	374	297
6NR-250 A/12A	150	200	1,15	329	272	708	654	636	606	558	516	444	390	300	708	654	636	606	558	516	444	390	300	708	654	636	606	558	516	444	390	300	
6NR-250 A/12	170	230	1,15	375	310	732	684	660	636	588	540	486	408	324	732	684	660	636	588	540	486	408	324	732	684	660	636	588	540	486	408	324	
6NR-250 A/13A	170	230	1,15	375	310	767	708,5	689	656,5	604,5	559	481	422,5	325	767	708,5	689	656,5	604,5	559	481	422,5	325	767	708,5	689	656,5	604,5	559	481	422,5	325	
6NR-250 A/13	185	250	1,15	412	340	793	741	715	689	637	585	526,5	442	351	793	741	715	689	637	585	526,5	442	351	793	741	715	689	637	585	526,5	442	351	
6NR-250 A/14A	185	250	1,15	412	340	826	763	742	707	651	602	518	455	350	826	763	742	707	651	602	518	455	350	826	763	742	707	651	602	518	455	350	
6NR-250 A/14	185	250	1,15	412	340	854	798	770	742	686	630	567	476	378	854	798	770	742	686	630	567	476	378	854	798	770	742	686	630	567	476	378	
6NR-250 A/15	185	250	1,15	412	340	885	817,5	795	757,5	697,5	645	555	487,5	375	885	817,5	795	757,5	697,5	645	555	487,5	375	885	817,5	795	757,5	697,5	645	555	487,5	375	
Livello minimo di battente alla griglia di aspirazione (m) • Min. hydrostatic head level to the suction grid (m) • Nivel de sumergencia min. de rejilla de aspiración (m)							1	1	1	1,5	2	2	2	2																			

* Funzionamento in orizzontale possibile (pompa e motore della stessa taglia a partire da 75 kW). Si raccomanda la corretta posa dei supporti onde evitare che l'elettropompa lavori a sbalzo. • Horizontal operation is possible (pump and motor of the same size starting from 75 kW). The motor shall be correctly installed with the relative supports in order to ensure the electric pump works properly. • El funcionamiento en posición horizontal es posible (bomba y motor de la misma medida a partir de 75 kW). Se aconseja colocar correctamente los soportes oportunos para evitar que la electrobomba funcione en voladizo.

• Potenza nominale motore • Rated power of motor • Potencia nominal del motor



SAER®

ELETTROPOMPE

10"

TABELLA DELLE CARATTERISTICHE IDRAULICHE

TABLE OF THE HYDRAULIC FEATURES
TABLA DE LAS CARACTERISTICAS HIDRAULICAS

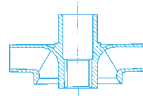

6NR-250

A-B-C

3600 l/min

Tipo Type	Motore Motor		S.F.	I _{sf} (A) 3~		Q	U.S.g.p.m.												
	kW	HP		380V	460V		0												
							m ³ /h												
							0												
							1500												
							1667												
							2000												
							2333												
							2667												
							3000												
							3333												
							3583												
							3833												
6NR-250 B/2A *	45	60	1,15	108	89	H (m)	116	97	94	86	77	66	53						
6NR-250 B/2 *	45	60	1,15	108	89		121	105	102	97	88	73	59						
6NR-250 B/3A *	60	80	1,15	139	115		174	145,5	141	129	115,5	99	79,5						
6NR-250 B/3 *	75	100	1,15	174	143		181,5	157,5	153	145,5	132	109,5	88,5						
6NR-250 B/4A *	83	113	1,15	194	160		232	194	188	172	154	132	106						
6NR-250 B/4 *	92	125	1,15	208	172		242	210	204	194	176	146	118						
6NR-250 B/5A *	110	150	1,15	247	204		290	242,5	235	215	192,5	165	132,5						
6NR-250 B5 *	132	180	1,15	296	245		302,5	262,5	255	242,5	220	182,5	147,5						
6NR-250 B6A *	132	180	1,15	296	245		348	291	282	258	231	198	159						
6NR-250 B/6 *	150	200	1,15	329	272		363	315	306	291	264	219	177						
6NR-250 B/7A *	150	200	1,15	329	272		406	339,5	329	301	269,5	231	185,5						
6NR-250 B/7	170	230	1,15	375	310		423,5	367,5	357	339,5	308	255,5	206,5						
6NR-250 B/8A	170	230	1,15	375	310		464	388	376	344	308	264	212						
6NR-250 B/8	185	250	1,15	412	340		484	420	408	388	352	292	236						
6NR-250 B/9A	185	250	1,15	412	340		522	436,5	423	387	346,5	297	238,5						
Livello minimo di battente alla griglia di aspirazione (m) • Min. hydrostatic head level to the suction grid (m) • Nivel de sumergencia min. de rejilla de aspiración (m)								1	1	1,5	2	2,5	3						
6NR-250 C/2A *	52	70	1,15	120	99	H (m)	117		100	95	90	82	74	64	55	46			
6NR-250 C/2 *	55	75	1,15	126	104		121		106	102	95	87	79	71	62	52			
6NR-250 C/3A *	75	100	1,15	174	143		175,5		150	142,5	135	123	111	96	82,5	69			
6NR-250 C/3 *	83	113	1,15	194	160		181,5		159	153	142,5	130,5	118,5	106,5	93	78			
6NR-250 C/4A *	110	150	1,15	247	204		234		200	190	180	164	148	128	110	92			
6NR-250 C/4 *	110	150	1,15	247	204		242		212	204	190	174	158	142	124	104			
6NR-250 C/5A *	132	180	1,15	296	245		292,5		250	237,5	225	205	185	160	137,5	115			
6NR-250 C/5 *	150	200	1,15	329	272		302,5		265	255	237,5	217,5	197,5	177,5	155	130			
6NR-250 C/6A *	150	200	1,15	329	272		351		300	285	270	246	222	192	165	138			
6NR-250 C/6	170	230	1,15	375	310		363		318	306	285	261	237	213	186	156			
6NR-250 C/7A	185	250	1,15	412	340		409,5		350	332,5	315	287	259	224	192,5	161			
Livello minimo di battente alla griglia di aspirazione (m) • Min. hydrostatic head level to the suction grid (m) • Nivel de sumergencia min. de rejilla de aspiración (m)									1	1	1	1,5	2	2	2,5	3			

* Funzionamento in orizzontale possibile (pompa e motore della stessa taglia a partire da 75 kW). Si raccomanda la corretta posa dei supporti onde evitare che l'elettropompa lavori a sbalzo. • Horizontal operation is possible (pump and motor of the same size starting from 75 kW). The motor shall be correctly installed with the relative supports in order to ensure the electric pump works properly. • El funcionamiento en posición horizontal es posible (bomba y motor de la misma medida a partir de 75 kW). Se aconseja colocar correctamente los soportes oportunos para evitar que la electrobomba funcione en voladizo.

• Potenza nominale motore • Rated power of motor • Potencia nominal del motor



10"

SAER®
ELETTROPOMPE

6NR-250A

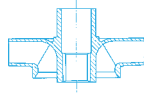

 $\cong 3600 \text{ l/min}$

CARATTERISTICHE IDRAULICHE

HYDRAULIC FEATURES / CARACTERISTICAS HIDRAULICAS

Tipo Type	Motore Motor		S.F.	I _{sf} (A) 3~		U.S.g.p.m.																		
	kW	HP		380V	460V	Q																		
						m ³ /h																		
						0	176	220	264	308	352	396	440	484	0	40	50	60	70	80	90	100	110	
															l/min	0	667	833	1000	1167	1333	1500	1667	1833
6NR-250 A/2A*	26	35	1,15	66,5	54,7										H (m)	118	109	106	101	93	86	74	65	50
6NR-250 A/2*	30	40	1,15	74,5	61,5											122	114	110	106	98	90	81	68	54
6NR-250 A/3A*	37	50	1,15	91	75											177	163,5	159	151,5	139,5	129	111	97,5	75
6NR-250 A/3*	45	60	1,15	108	89											183	171	165	159	147	135	121,5	102	81
6NR-250 A/4A*	52	70	1,15	120	99											236	218	212	202	186	172	148	130	100
6NR-250 A/4*	55	75	1,15	126	104											244	228	220	212	196	180	162	136	108
6NR-250 A/5A*	60	80	1,15	139	115											295	272,5	265	252,5	232,5	215	185	162,5	125
6NR-250 A/5*	67	90	1,15	160	132											305	285	275	265	245	225	202,5	170	135
6NR-250 A/6A*	75	100	1,15	174	143											354	327	318	303	279	258	222	195	150
6NR-250 A/6*	83	113	1,15	194	160											366	342	330	318	294	270	243	204	162
6NR-250 A/7A*	92	125	1,15	208	172											413	381,5	371	353,5	325,5	301	259	227,5	175
6NR-250 A/7*	92	125	1,15	208	172											427	399	385	371	343	315	283,5	238	189
6NR-250 A/8A*	110	150	1,15	247	204											472	436	424	404	372	344	296	260	200
6NR-250 A/8*	110	150	1,15	247	204											488	456	440	424	392	360	324	272	216
6NR-250 A/9A*	110	150	1,15	247	204											531	490,5	477	454,5	418,5	387	333	292,5	225
6NR-250 A/9	132	180	1,15	296	245										549	513	495	477	441	405	364,5	306	243	
6NR-250 A/10A	132	180	1,15	296	245										590	545	530	505	465	430	370	325	250	
6NR-250 A/10	132	180	1,15	296	245										610	570	550	530	490	450	405	340	270	
6NR-250 A/11A	132	180	1,15	296	245										649	599,5	583	555,5	511,5	473	407	357,5	275	
6NR-250 A/11	150	200	1,15	329	272										671	627	605	583	539	495	445,5	374	297	
6NR-250 A/12A	150	200	1,15	329	272										708	654	636	606	558	516	444	390	300	
6NR-250 A/12	170	230	1,15	375	310										732	684	660	636	588	540	486	408	324	
6NR-250 A/13A	170	230	1,15	375	310										767	708,5	689	656,5	604,5	559	481	422,5	325	
6NR-250 A/13	185	250	1,15	412	340										793	741	715	689	637	585	526,5	442	351	
6NR-250 A/14A	185	250	1,15	412	340										826	763	742	707	651	602	518	455	350	
6NR-250 A/14	185	250	1,15	412	340										854	798	770	742	686	630	567	476	378	
6NR-250 A/15	185	250	1,15	412	340										885	817,5	795	757,5	697,5	645	555	487,5	375	
Livello minimo di battente alla griglia di aspirazione (m) • Min. hydrostatic head level to the suction grid (m) • Nivel de surgencia min. de rejilla de aspiración (m)							1	1	1	1,5	2	2	2	2										

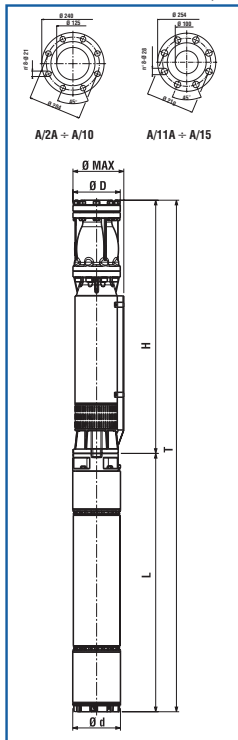
* Funzionamento in orizzontale possibile (pompa e motore della stessa taglia a partire da 75 kW). Si raccomanda la corretta posa dei supporti onde evitare che l'elettropompa lavori a sbalzo. • Horizontal operation is possible (pump and motor of the same size starting from 75 kW). The motor shall be correctly installed with the relative supports in order to ensure the electric pump works properly. • El funcionamiento en posición horizontal es posible (bomba y motor de la misma medida a partir de 75 kW). Se aconseja colocar correctamente los soportes oportunos para evitar que la electrobomba funcione en voladizo. • Potenza nominale motore • Rated power of motor • Potencia nominal del motor



DIMENSIONI E PESI

DIMENSIONS AND WEIGHT / DIMENSIONES Y PESOS

Tipo / Type		T (mm)	H (mm)	L (mm)	Ø Max (mm)	Ø D "G"	Ø d (mm)	Motore Motor	NEMA	Peso Weight (Kg)	
T	H									H	T
6NR-250 A/2A	RP-250 A/2A	1791	946	845	264	5"	192	8" MS 201	1.18.424	113	239
6NR-250 A/2	RP-250 A/2	1791	946	845	264	5"	192	8" MS 201	1.18.424	113	239
6NR-250 A/3A	RP-250 A/3A	1951	1026	925	264	5"	192	8" MS 201	1.18.424	125	267
6NR-250 A/3	RP-250 A/3	2021	1026	995	264	5"	192	8" MS 201	1.18.424	125	281
6NR-250 A/4A	RP-250 A/4A	2171	1106	1065	264	5"	192	8" MS 201	1.18.424	137	307
6NR-250 A/4	RP-250 A/4	2171	1106	1065	264	5"	192	8" MS 201	1.18.424	137	307
6NR-250 A/5A	RP-250 A/5A	2321	1186	1135	264	5"	192	8" MS 201	1.18.424	149	333
6NR-250 A/5	RP-250 A/5	2421	1186	1235	264	5"	192	8" MS 201	1.18.424	149	353
6NR-250 A/6A	RP-250 A/6A	2601	1266	1335	264	5"	192	8" MS 201	1.18.424	161	384
6NR-250 A/6	RP-250 A/6	2681	1266	1415	264	5"	192	8" MS 201	1.18.424	161	400
6NR-250 A/7A	RP-250 A/7A	2841	1346	1495	264	5"	192	8" MS 201	1.18.424	172	427
6NR-250 A/7	RP-250 A/7	2841	1346	1495	264	5"	192	8" MS 201	1.18.424	172	427
6NR-250 A/8A	RP-250 A/8A	3011	1426	1585	264	5"	238	10" MS 251	-	184	457
6NR-250 A/8	RP-250 A/8	3011	1426	1585	264	5"	238	10" MS 251	-	184	457
6NR-250 A/9A	RP-250 A/9A	3208	1623	1585	264	5"	238	10" MS 251	-	211	484
6NR-250 A/9	RP-250 A/9	3193	1623	1570	264	5"	238	10" MS 251	-	211	609
6NR-250 A/10A	RP-250 A/10A	3273	1703	1570	264	5"	238	10" MS 251	-	223	621
6NR-250 A/10	RP-250 A/10	3273	1703	1570	264	5"	238	10" MS 251	-	223	621
6NR-250 A/11A	6RP-250 A/11A	3353	1783	1570	264	5"	238	10" MS 251	-	235	633
6NR-250 A/11	6RP-250 A/11	3443	1783	1660	264	5"	238	10" MS 251	-	235	655
6NR-250 A/12A	6RP-250 A/12A	3523	1863	1660	264	5"	238	10" MS 251	-	247	667
6NR-250 A/12	6RP-250 A/12	3663	1863	1800	264	5"	238	10" MS 251	-	247	701
6NR-250 A/13A	6RP-250 A/13A	3743	1943	1800	264	5"	238	10" MS 251	-	262	716
6NR-250 A/13	6RP-250 A/13	3853	1943	1910	264	5"	238	10" MS 251	-	262	743
6NR-250 A/14A	6RP-250 A/14A	3933	2023	1910	264	5"	238	10" MS 251	-	273	754
6NR-250 A/14	6RP-250 A/14	3933	2023	1910	264	5"	238	10" MS 251	-	273	754
6NR-250 A/15	6RP-250 A/15	4013	2103	1910	264	5"	238	10" MS 251	-	285	766



SAER®

10"

ELETTROPOMPE

≅ 3600 l/min

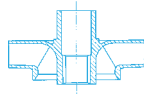

6NR-250A

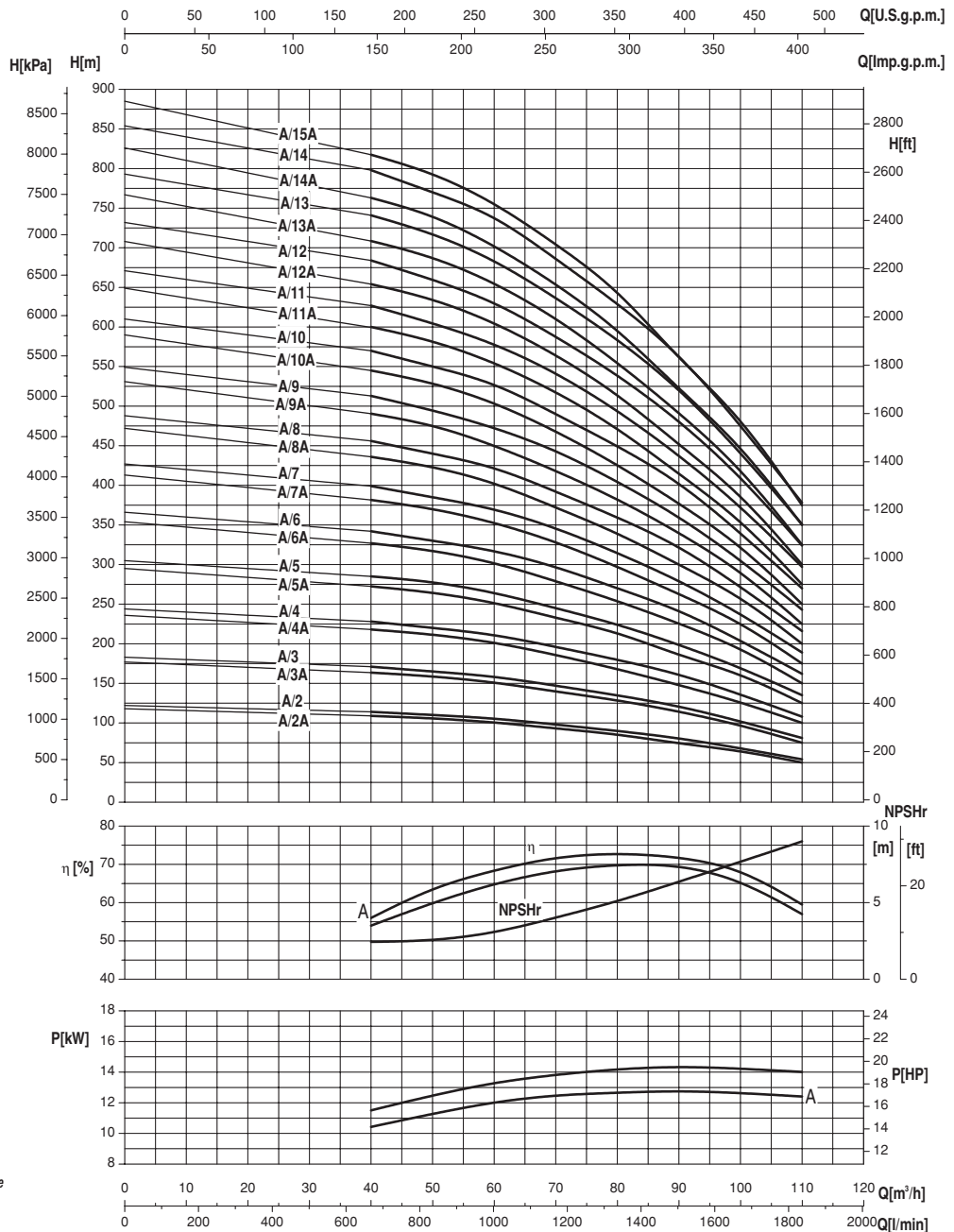

Moltiplicare il rendimento per il coefficiente corrispondente al vostro numero di stadi.

Multiply efficiency by the coefficient corresponding the number of stages.

Multiplicar el rendimiento por el coeficiente correspondiente a Su numero de etapas.

Numero di stadi Number of stage Numero de etapas	<4	5	6	>6
Coefficienti Coefficient Coeficiente	0,97	0,98	0,99	1

- Potenza assorbita per stadio
- Absorbed power for each single stage
- Potencia absorbida por cada etapa

Le curve di prestazione sono basate su valori di viscosità cinematica = 1 mm²/s e densità pari a 1000 kg/m³. Tolleranza e curve secondo UNI EN ISO 9906 - Appendice A • The performance curves are based on the kinematic viscosity values = 1 mm²/s and density equal to 1000 kg/m³. Tolerance and curves according to UNI EN ISO 9906 - Attachment A • Las curvas de rendimiento se refieren a valores de viscosidad cinemática = 1 mm²/s y densidad de 1000 Kg/m³. Tolerancia de las curvas de acuerdo con UNI EN ISO 9906 - Parrafo A.



10"

SAER®
ELETTROPOMPE

6NR-250B

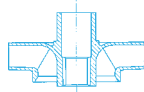
 $\cong 3600 \text{ l/min}$

CARATTERISTICHE IDRAULICHE

HYDRAULIC FEATURES / CARACTERISTICAS HIDRAULICAS

Tipo Type	Motore Motor		S.F.	I _{sf} (A) 3~		U.S.g.p.m. Q	0	396	440	484	528	572	616	660	705	748	793	
	kW	HP		380V	460V		m ³ /h	0	90	100	110	120	130	140	150	160	170	180
							l/min	0	1500	1667	1833	2000	2167	2333	2500	2667	2833	3000
6NR-250 B/2A *	45	60	1,15	108	89	H (m)	116	97	94	90	86	82	77	71	66	60	53	
6NR-250 B/2 *	45	60	1,15	108	89		121	105	102	100	97	92	88	80	73	66	59	
6NR-250 B/3A *	60	80	1,15	139	115		174	145,5	141	135	129	123	115,5	106,5	99	90	79,5	
6NR-250 B/3 *	75	100	1,15	174	143		181,5	157,5	153	150	145,5	138	132	120	109,5	99	88,5	
6NR-250 B/4A *	83	113	1,15	194	160		232	194	188	180	172	164	154	142	132	120	106	
6NR-250 B/4 *	92	125	1,15	208	172		242	210	204	200	194	184	176	160	146	132	118	
6NR-250 B/5A *	110	150	1,15	247	204		290	242,5	235	225	215	205	192,5	177,5	165	150	132,5	
6NR-250 B5 *	132	180	1,15	296	245		302,5	262,5	255	250	242,5	230	220	200	182,5	165	147,5	
6NR-250 B6A *	132	180	1,15	296	245		348	291	282	270	258	246	231	213	198	180	159	
6NR-250 B/6 *	150	200	1,15	329	272		363	315	306	300	291	276	264	240	219	198	177	
6NR-250 B/7A *	150	200	1,15	329	272		406	339,5	329	315	301	287	269,5	248,5	231	210	185,5	
6NR-250 B/7 *	170	230	1,15	375	310		423,5	367,5	357	350	339,5	322	308	280	255,5	231	206,5	
6NR-250 B/8A *	170	230	1,15	375	310		464	388	376	360	344	328	308	284	264	240	212	
6NR-250 B/8 *	185	250	1,15	412	340		484	420	408	400	388	368	352	320	292	264	236	
6NR-250 B/9A *	185	250	1,15	412	340		522	436,5	423	405	387	369	346,5	319,5	297	270	238,5	
Livello minimo di battente alla griglia di aspirazione (m) • Min. hydrostatic head level to the suction grid (m) • Nivel de sumergencia min. de rejilla de aspiración (m)							1	1	1	1,5	2	2	2,5	2,5	3	3		

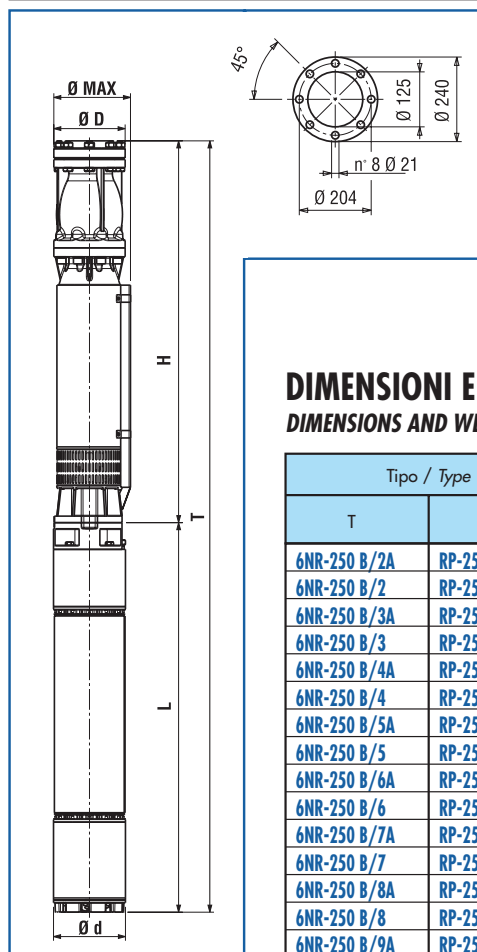

* Funzionamento in orizzontale possibile (pompa e motore della stessa taglia a partire da 75 kW).
 Si raccomanda la corretta posa dei supporti onde evitare che l'elettropompa lavori a sbalzo.
 • Horizontal operation is possible (pump and motor of the same size starting from 75 kW). The motor shall be correctly installed with the relative supports in order to ensure the electric pump works properly
 • El funcionamiento en posición horizontal es posible (bomba y motor de la misma medida a partir de 75 kW). Se aconseja colocar correctamente los soportes oportunos para evitar que la electrobomba funcione en voladizo.

• Potenza nominale motore • Rated power of motor • Potencia nominal del motor.

DIMENSIONI E PESI

DIMENSIONS AND WEIGHT / DIMENSIONES Y PESOS

Tipo / Type		T (mm)	H (mm)	L (mm)	Ø Max (mm)	Ø D "G	Ø d (mm)	Motore Motor	NEMA	Peso Weight (Kg)	
T	H									H	T
6NR-250 B/2A	RP-250 B/2A	1961	966	995	264	5"	192	8" MS 201	1.18.424	114	270
6NR-250 B/2	RP-250 B/2	1961	966	995	264	5"	192	8" MS 201	1.18.424	114	270
6NR-250 B/3A	RP-250 B/3A	2191	1056	1135	264	5"	192	8" MS 201	1.18.424	126	310
6NR-250 B/3	RP-250 B/3	2391	1056	1335	264	5"	192	8" MS 201	1.18.424	126	349
6NR-250 B/4A	RP-250 B/4A	2561	1146	1415	264	5"	192	8" MS 201	1.18.424	138	377
6NR-250 B/4	RP-250 B/4	2641	1146	1495	264	5"	192	8" MS 201	1.18.424	138	393
6NR-250 B/5A	RP-250 B/5A	2821	1236	1585	264	5"	238	10" MS 251	-	150	423
6NR-250 B/5	RP-250 B/5	2806	1236	1570	264	5"	238	10" MS 251	-	150	548
6NR-250 B/6A	RP-250 B/6A	2896	1326	1570	264	5"	238	10" MS 251	-	162	560
6NR-250 B/6	RP-250 B/6	2986	1326	1660	264	5"	238	10" MS 251	-	162	582
6NR-250 B/7A	RP-250 B/7A	3076	1416	1660	264	5"	238	10" MS 251	-	174	594
6NR-250 B/7	RP-250 B/7	3216	1416	1800	264	5"	238	10" MS 251	-	174	628
6NR-250 B/8A	RP-250 B/8A	3306	1506	1800	264	5"	238	10" MS 251	-	186	640
6NR-250 B/8	RP-250 B/8	3416	1506	1910	264	5"	238	10" MS 251	-	186	667
6NR-250 B/9A	RP-250 B/9A	3643	1733	1910	264	5"	238	10" MS 251	-	217	698



SAER®

10"

ELETTROPOMPE

≅ 3600 l/min

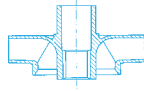

6NR-250B

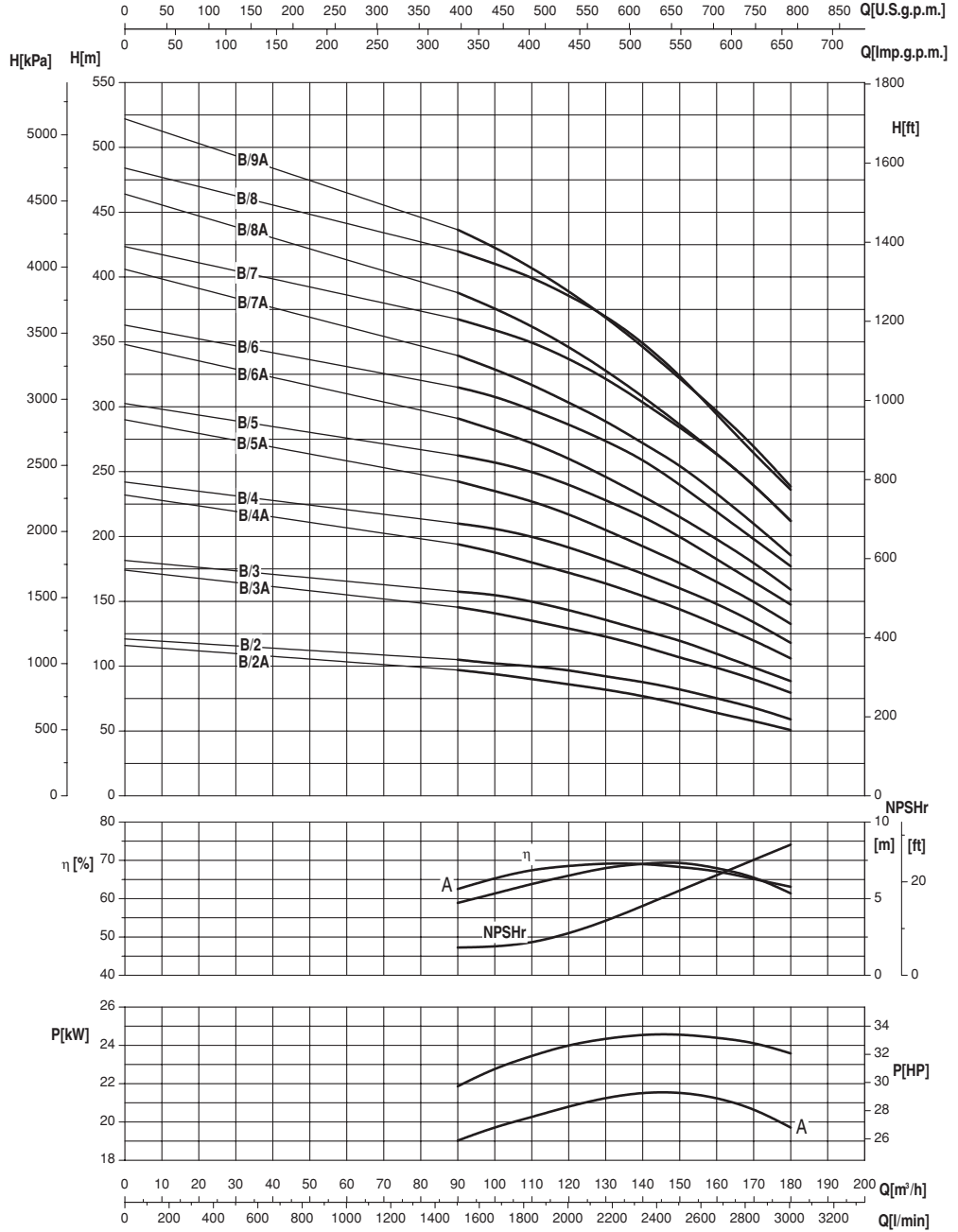

Moltiplicare il rendimento per il coefficiente corrispondente al vostro numero di stadi.

Multiply efficiency by the coefficient corresponding to the number of stages.

Multiplificar el rendimiento por el coeficiente correspondiente a su número de etapas.

Numero di stadi Number of stage Numero de etapas	<3	4	5	>5
Coefficienti Coefficient Coeficiente	0,97	0,98	0,99	1

- Potenza assorbita per stadio
- Absorbed power for each single stage
- Potencia absorbida por cada etapa

Le curve di prestazione sono basate su valori di viscosità cinematica = 1 mm²/s e densità pari a 1000 kg/m³. Tolleranza e curve secondo UNI EN ISO 9906 - Appendice A • The performance curves are based on the kinematic viscosity values = 1 mm²/s and density equal to 1000 kg/m³. Tolerance and curves according to UNI EN ISO 9906 - Attachment A • Las curvas de rendimiento se refieren a valores de viscosidad cinemática = 1 mm²/s y densidad de 1000 Kg/m³. Tolerancia de las curvas de acuerdo con UNI EN ISO 9906 - Parrafo A.



10"

SAER®
ELETTROPOMPE

6NR-250C

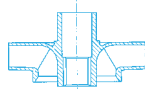
 $\cong 3600 \text{ 1/min}$

CARATTERISTICHE IDRAULICHE

HYDRAULIC FEATURES / CARACTERISTICAS HIDRAULICAS

Tipo Type	Motore Motor		S.F.	I _{sf} (A) 3~		U.S.g.p.m. Q	0	440	530	615	705	790	881	946	1012	
	kW	HP		380V	460V		m ³ /h	0	100	120	140	160	180	200	215	230
							l/min	0	1667	2000	2333	2667	3000	3333	3583	3833
6NR-250 C/2A *	52	70	1,15	120	99	H (m)	117	100	95	90	82	74	64	55	46	
6NR-250 C/2 *	55	75	1,15	126	104		121	106	102	95	87	79	71	62	52	
6NR-250 C/3A *	75	100	1,15	174	143		175,5	150	142,5	135	123	111	96	82,5	69	
6NR-250 C/3 *	83	113	1,15	194	160		181,5	159	153	142,5	130,5	118,5	106,5	93	78	
6NR-250 C/4A *	110	150	1,15	247	204		234	200	190	180	164	148	128	110	92	
6NR-250 C/4 *	110	150	1,15	247	204		242	212	204	190	174	158	142	124	104	
6NR-250 C/5A *	132	180	1,15	296	245		292,5	250	237,5	225	205	185	160	137,5	115	
6NR-250 C/5 *	150	200	1,15	329	272		302,5	265	255	237,5	217,5	197,5	177,5	155	130	
6NR-250 C/6A *	150	200	1,15	329	272		351	300	285	270	246	222	192	165	138	
6NR-250 C/6	170	230	1,15	375	310		363	318	306	285	261	237	213	186	156	
6NR-250 C/7A	185	250	1,15	412	340		409,5	350	332,5	315	287	259	224	192,5	161	
Livello minimo di battente alla griglia di aspirazione (m) • Min. hydrostatic head level to the suction grid (m) • Nivel de sumergencia min. de rejilla de aspiración (m)							1	1	1	1,5	2	2	2,5	3		

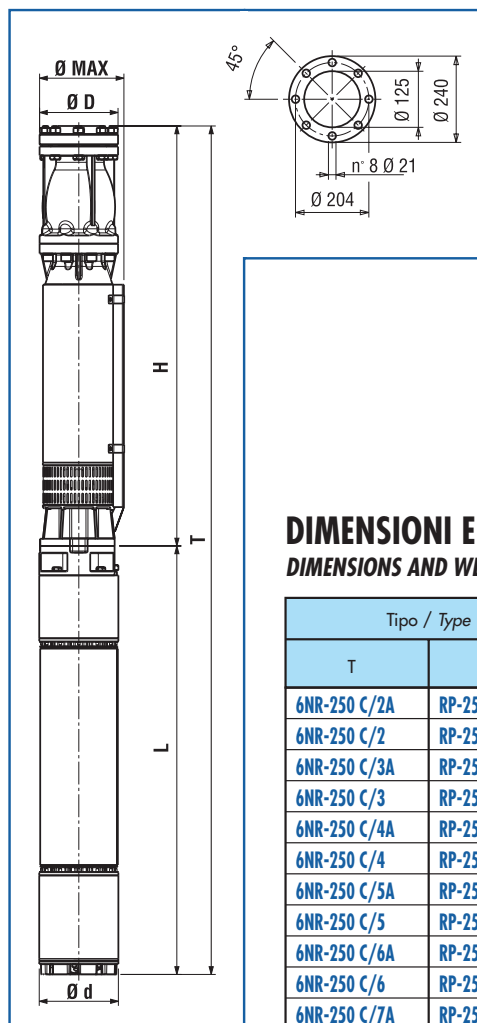

* Funzionamento in orizzontale possibile (pompa e motore della stessa taglia a partire da 75 kW).
 Si raccomanda la corretta posa dei supporti onde evitare che l'elettropompa lavori a sbalzo.
 • Horizontal operation is possible (pump and motor of the same size starting from 75 kW). The motor shall be correctly installed with the relative supports in order to ensure the electric pump works properly.
 • El funcionamiento en posición horizontal es posible (bomba y motor de la misma medida a partir de 75 kW). Se aconseja colocar correctamente los soportes oportunos para evitar que la electrobomba funcione en voladizo.

• Potenza nominale motore • Rated power of motor • Potencia nominal del motor.

DIMENSIONI E PESI

DIMENSIONS AND WEIGHT / DIMENSIONES Y PESOS

Tipo / Type		T	H	L	Ø Max	Ø D	Ø d	Motore Motor	NEMA	Peso Weight (Kg)	
T	H									H	T
6NR-250 C/2A	RP-250 C/2A	2051	986	1065	264	5"	192	8" MS 201	1.18.424	115	285
6NR-250 C/2	RP-250 C/2	2051	986	1065	264	5"	192	8" MS 201	1.18.424	115	285
6NR-250 C/3A	RP-250 C/3A	2421	1086	1335	264	5"	192	8" MS 201	1.18.424	130	353
6NR-250 C/3	RP-250 C/3	2501	1086	1415	264	5"	192	8" MS 201	1.18.424	130	369
6NR-250 C/4A	RP-250 C/4A	2771	1186	1585	264	5"	238	10" MS 251	-	139	412
6NR-250 C/4	RP-250 C/4	2771	1186	1585	264	5"	238	10" MS 251	-	139	412
6NR-250 C/5A	RP-250 C/5A	2856	1286	1570	264	5"	238	10" MS 251	-	152	550
6NR-250 C/5	RP-250 C/5	2946	1286	1660	264	5"	238	10" MS 251	-	152	572
6NR-250 C/6A	RP-250 C/6A	3046	1386	1660	264	5"	238	10" MS 251	-	165	585
6NR-250 C/6	RP-250 C/6	3186	1386	1800	264	5"	238	10" MS 251	-	165	619
6NR-250 C/7A	RP-250 C/7A	3416	1506	1910	264	5"	238	10" MS 251	-	181	662



SAER®

10"

ELETTROPOMPE

≈ 3600 l/min

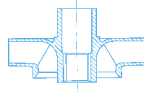

6NR-250C

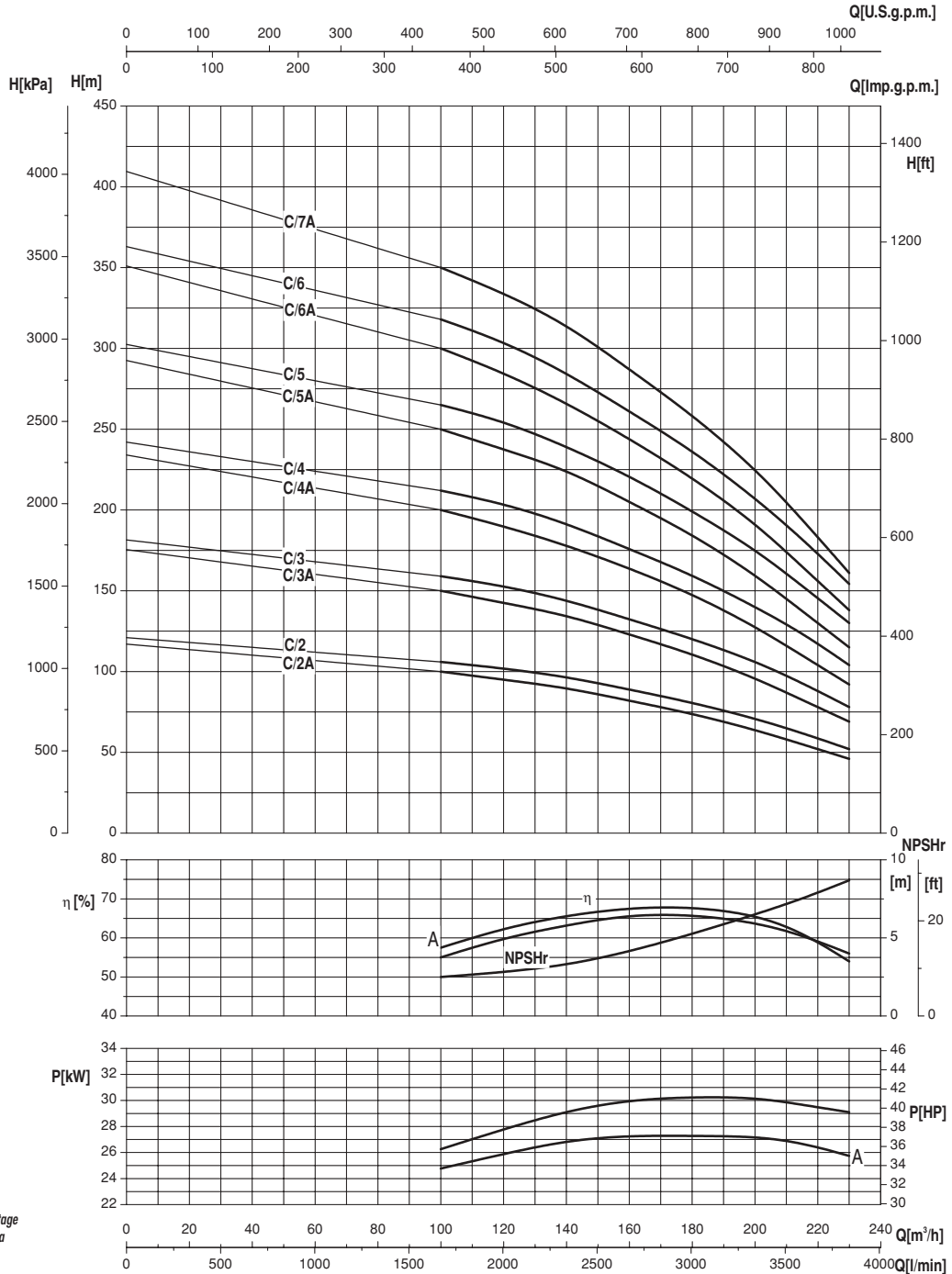

Moltiplicare il rendimento per il coefficiente corrispondente al vostro numero di stadi.

Multiply efficiency by the coefficient corresponding to the number of stages.

Multiplicar el rendimiento por el coeficiente correspondiente a su número de etapas.

Numero di stadi Number of stage Numero de etapas	<3	3	4	>4
Coefficienti Coefficient Coeficiente	0,97	0,98	0,99	1

- Potenza assorbita per stadio
- Absorbed power for each single stage
- Potencia absorbida por cada etapa

Le curve di prestazione sono basate su valori di viscosità cinematica = 1 mm²/s e densità pari a 1000 kg/m³. Tolleranza e curve secondo UNI EN ISO 9906 - Appendice A • The performance curves are based on the kinematic viscosity values = 1 mm²/s and density equal to 1000 kg/m³. Tolerance and curves according to UNI EN ISO 9906 - Attachment A • Las curvas de rendimiento se refieren a valores de viscosidad cinemática = 1 mm²/s y densidad de 1000 Kg/m³. Tolerancia de las curvas de acuerdo con UNI EN ISO 9906 - Parrafo A.