



PLAGE DES PERFORMANCES

- Débit jusqu'à **6000 l/min** (360 m³/h)
- Hauteur manométrique totale jusqu'à **95 m**

LIMITES D'UTILISATION

- Hauteur manométrique d'aspiration jusqu'à **7 m**
- Température du liquide de **-10 °C à +90 °C**
- Pression maxi dans le corps de pompe **10 bar** (PN10)

EXÉCUTION ET NORMES DE SÉCURITÉ

EN 733



RÈGLEMENT (UE) N. 547/2012

CERTIFICATIONS

COMPANY WITH MANAGEMENT SYSTEM
CERTIFIED BY DNV
ISO 9001: QUALITY
ISO 14001: ENVIRONMENT AND SAFETY

UTILISATIONS ET INSTALLATIONS

- Approvisionnement en eau
- Surpression
- Irrigation
- Circulation d'eau dans des installations de climatisation
- Installations de lavage
- Installations anti-incendie
- Industrie
- Agriculture

EXÉCUTIONS SUR DEMANDE

- Garniture mécanique spéciale
- Contre-bridés
- Pompes pour moteurs avec fréquence 60 Hz
- Pour liquides avec températures plus élevées ou plus basses
- Pour environnements avec températures plus élevées ou plus basses

GARANTIE

2 ans selon nos conditions générales de vente

PLAGE DES PERFORMANCES

HS = 0 m

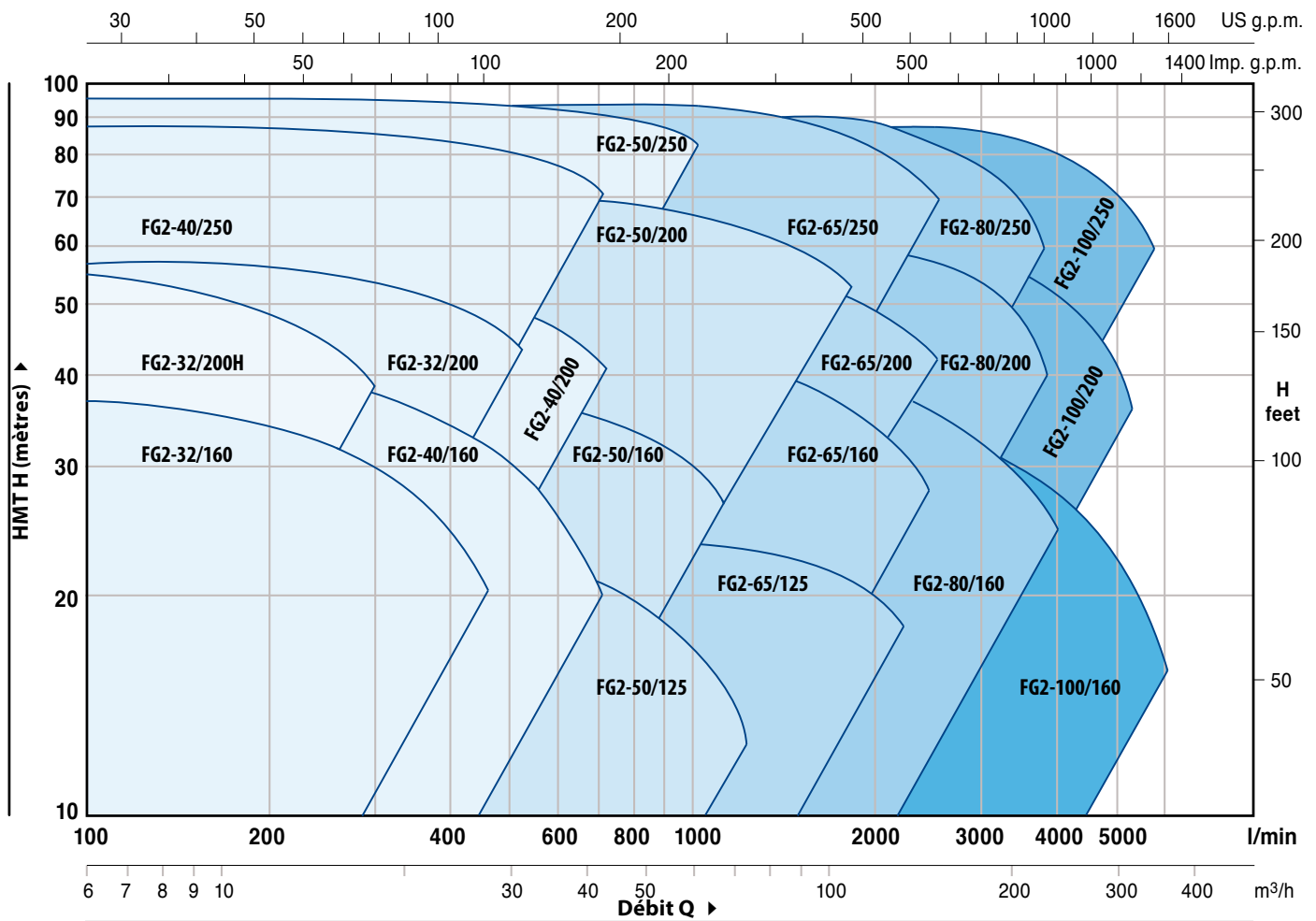

CARACTÉRISTIQUES DE PERFORMANCE

HS = 0 m

TYPE	MOTEUR À ACCOUPLER		PERFORMANCES	
	kW	HP	Q m³/h	H mètres
pompe				
FG2 32/160B	2.2	3	6 ÷ 24	30 ÷ 17
FG2 32/160A	3	4	6 ÷ 27	37 ÷ 24
FG2 32/200C	4	5.5	6 ÷ 27	44 ÷ 31.5
FG2 32/200B	5.5	7.5	6 ÷ 30	51 ÷ 36
FG2 32/200A	7.5	10	6 ÷ 30	57 ÷ 44
FG2 32/200BH	3	4	6 ÷ 18	45 ÷ 37
FG2 32/200AH	4	5.5	6 ÷ 19.2	55 ÷ 44
FG2 40/160C	2.2	3	6 ÷ 36	27 ÷ 14
FG2 40/160B	3	4	6 ÷ 36	32 ÷ 20
FG2 40/160A	4	5.5	6 ÷ 42	38 ÷ 20
FG2 40/200B	5.5	7.5	6 ÷ 42	47 ÷ 28
FG2 40/200A	7.5	10	6 ÷ 42	55 ÷ 41
FG2 40/250C	9.2	12.5	6 ÷ 42	64 ÷ 47
FG2 40/250B	11	15	6 ÷ 42	71 ÷ 55
FG2 40/250A	15	20	6 ÷ 42	88 ÷ 72
FG2 50/125C	2.2	3	18 ÷ 72	17.5 ÷ 6
FG2 50/125B	3	4	18 ÷ 72	20.7 ÷ 9
FG2 50/125A	4	5.5	18 ÷ 72	23.5 ÷ 13
FG2 50/160C	4	5.5	18 ÷ 60	27 ÷ 16
FG2 50/160B	5.5	7.5	18 ÷ 66	32 ÷ 21
FG2 50/160A	7.5	10	18 ÷ 66	37 ÷ 27
FG2 50/200C	11	15	24 ÷ 102	44 ÷ 30
FG2 50/200B	15	20	24 ÷ 102	52 ÷ 38
FG2 50/200A	18.5	25	24 ÷ 108	61 ÷ 45
FG2 50/200AR	22	30	24 ÷ 108	69 ÷ 53
FG2 50/250D	9.2	12.5	18 ÷ 54	51 ÷ 32
FG2 50/250C	11	15	18 ÷ 54	59 ÷ 42
FG2 50/250B	15	20	18 ÷ 60	72 ÷ 59
FG2 50/250A	18.5	25	18 ÷ 60	85 ÷ 73
FG2 50/250AR	22	30	18 ÷ 60	95 ÷ 83

TYPE	MOTEUR À ACCOUPLER		PERFORMANCES	
	kW	HP	Q m³/h	H mètres
pump				
FG2 65/125B	5.5	7.5	36 ÷ 108	18 ÷ 13
FG2 65/125A	7.5	10	36 ÷ 132	23 ÷ 18
FG2 65/160C	9.2	12.5	36 ÷ 132	32 ÷ 22
FG2 65/160B	11	15	36 ÷ 144	36.5 ÷ 23
FG2 65/160A	15	20	36 ÷ 144	40.5 ÷ 28
FG2 65/200B	15	20	12 ÷ 144	44 ÷ 30.5
FG2 65/200A	18.5	25	12 ÷ 156	50 ÷ 36.5
FG2 65/200AR	22	30	12 ÷ 156	57 ÷ 42
FG2 65/250C	30	40	24 ÷ 141	76 ÷ 53
FG2 65/250B	37	50	24 ÷ 150	87 ÷ 62
FG2 65/250A	45	60	24 ÷ 156	94.5 ÷ 68
FG2 80/160D	11	15	30 ÷ 240	25 ÷ 10
FG2 80/160C	15	20	30 ÷ 240	30 ÷ 15
FG2 80/160B	18.5	25	30 ÷ 240	35 ÷ 20
FG2 80/160A	22	30	30 ÷ 240	40 ÷ 25
FG2 80/200B	30	40	30 ÷ 219	56 ÷ 34.5
FG2 80/200A	37	50	30 ÷ 234	62 ÷ 40
FG2 80/250B	45	60	36 ÷ 216	77 ÷ 54
FG2 80/250A	55	75	36 ÷ 234	88.5 ÷ 60
FG2 100/160C	15	20	60 ÷ 300	28 ÷ 12
FG2 100/160B	18.5	25	60 ÷ 330	32 ÷ 13
FG2 100/160A	22	30	60 ÷ 360	35 ÷ 15
FG2 100/200C	30	40	48 ÷ 279	51 ÷ 28
FG2 100/200B	37	50	48 ÷ 294	57 ÷ 33
FG2 100/200A	45	60	48 ÷ 315	63 ÷ 38
FG2 100/250B	55	75	48 ÷ 309	75 ÷ 48
FG2 100/250A	75	100	48 ÷ 345	89 ÷ 58

COURBES DE PERFORMANCE

HS = 0 m

FG2 32/160

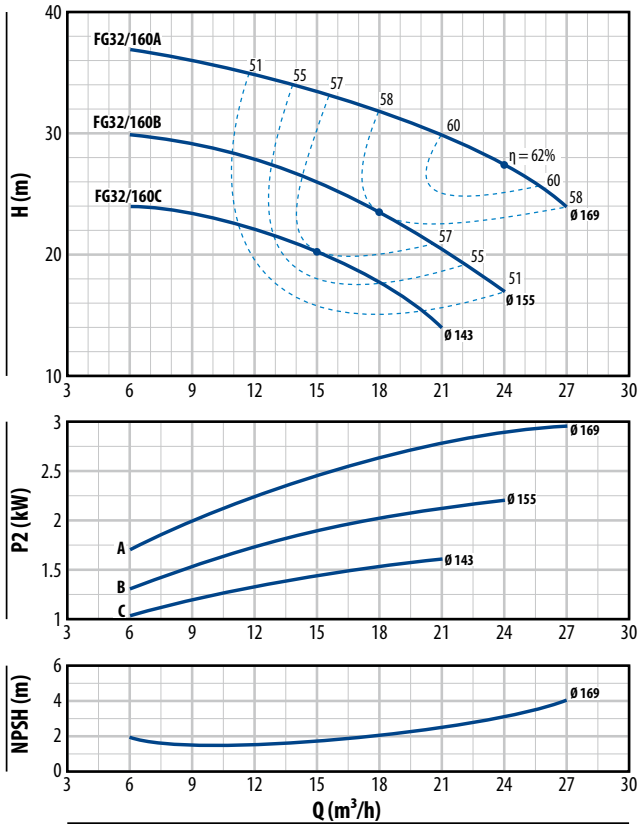

FG2 32/200

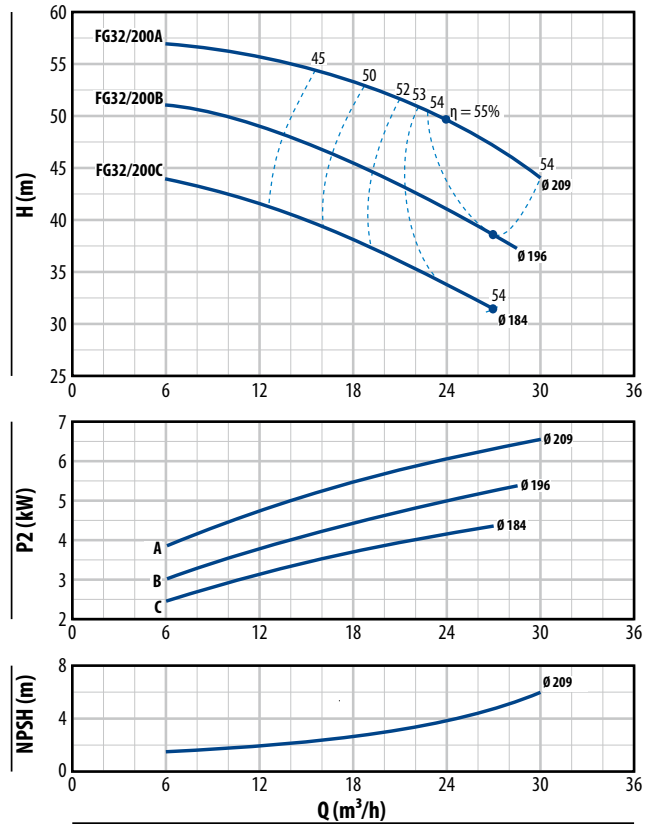

FG2 32/200H

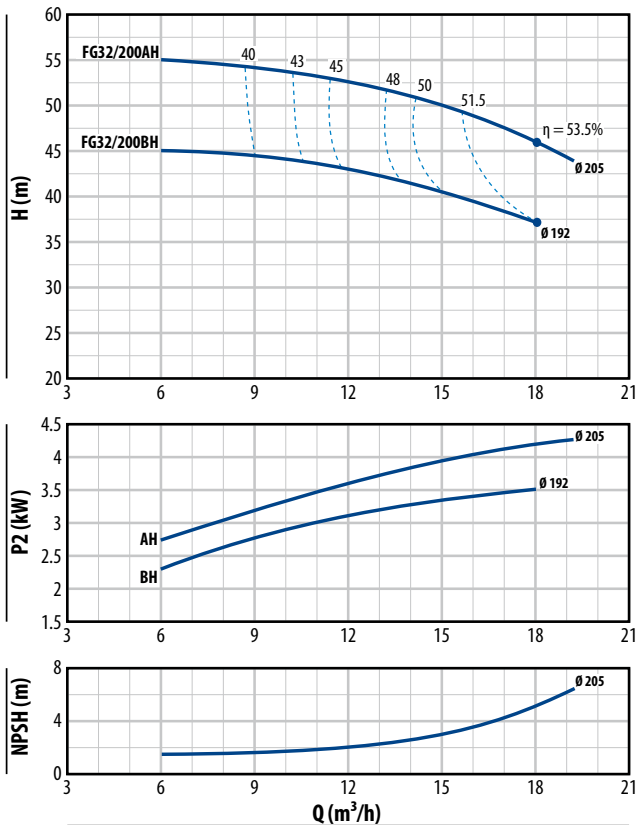

FG2 40/160

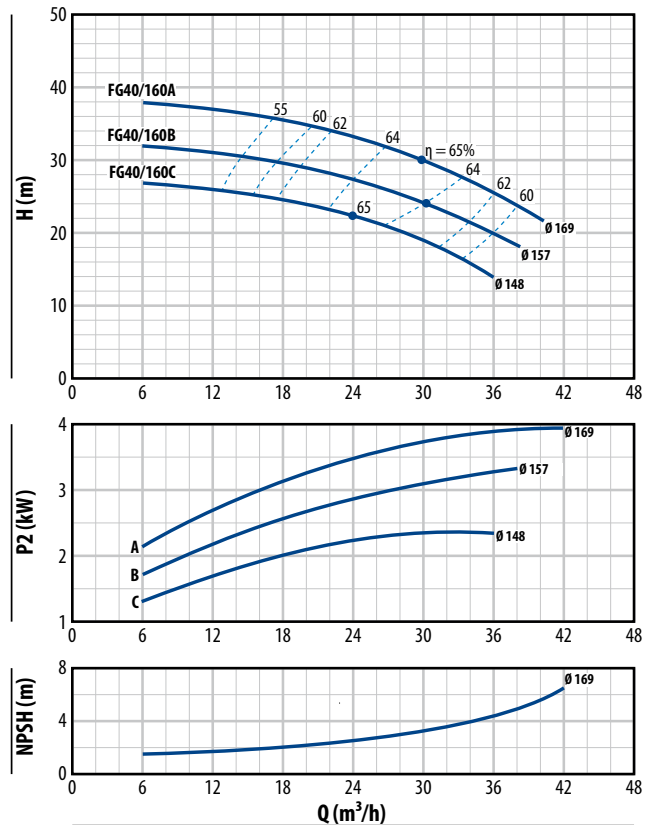

COURBES DE PERFORMANCE

HS = 0 m

FG2 40/200

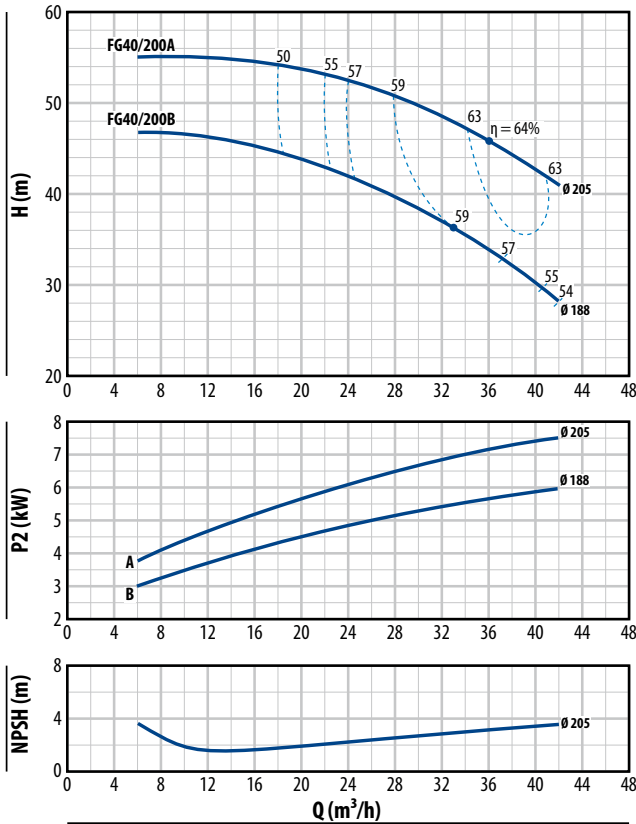

FG2 40/250

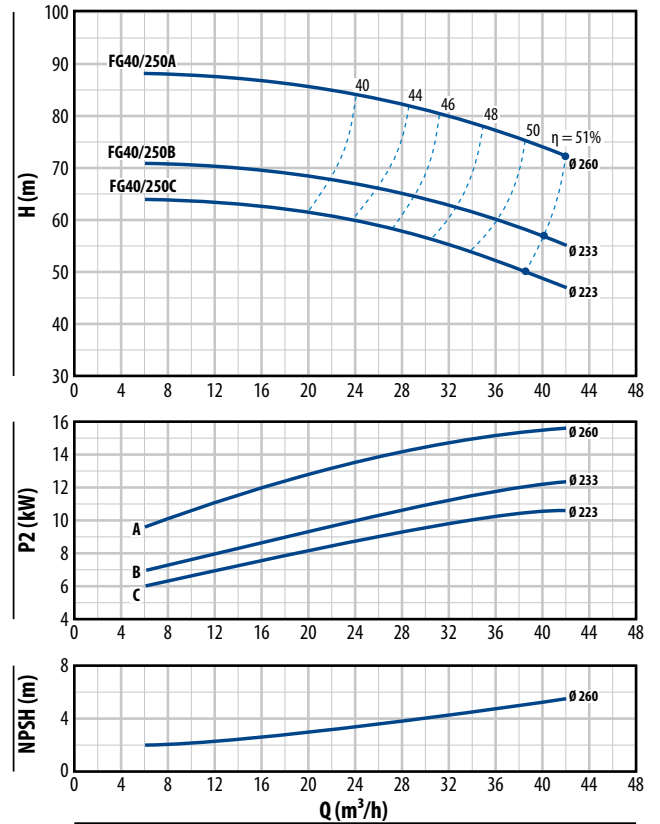

FG2 50/125

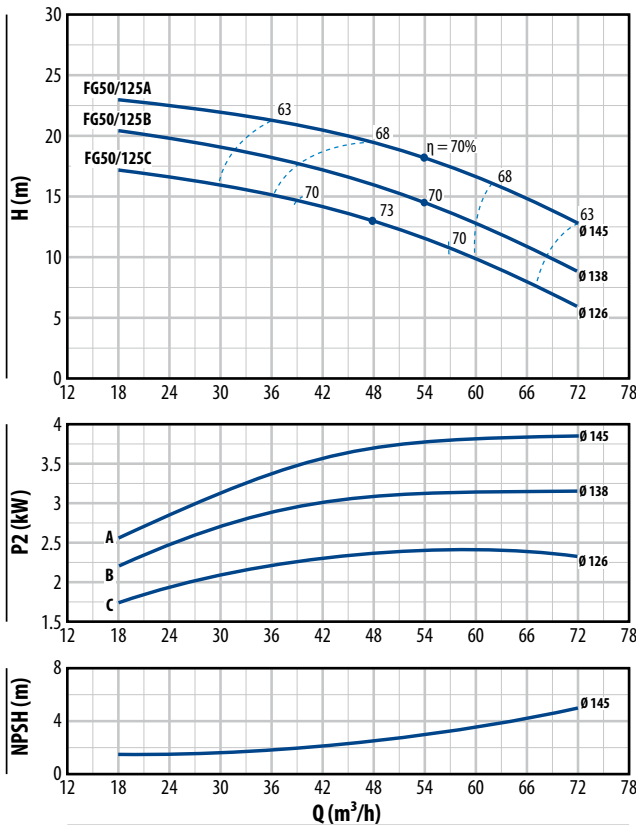

FG2 50/160

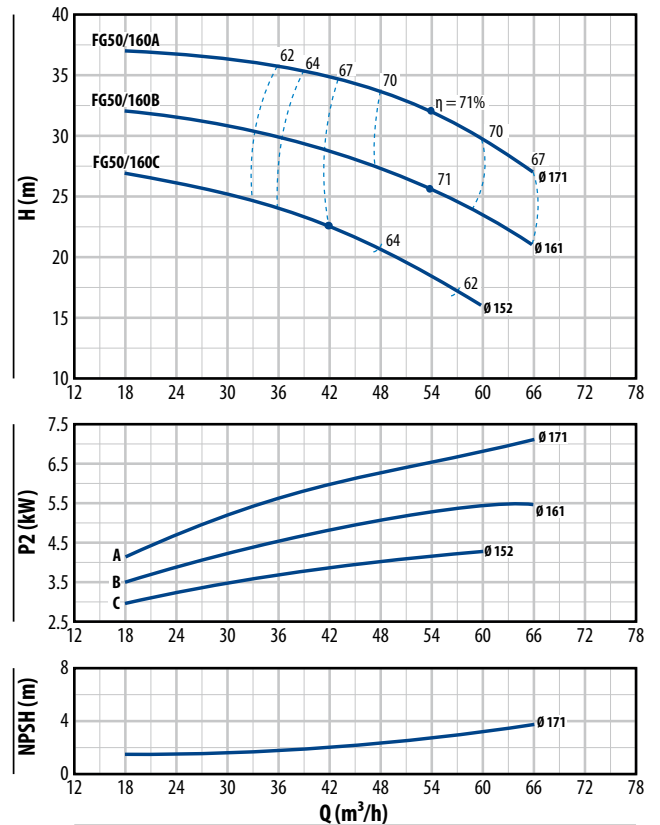

FG2 50/200

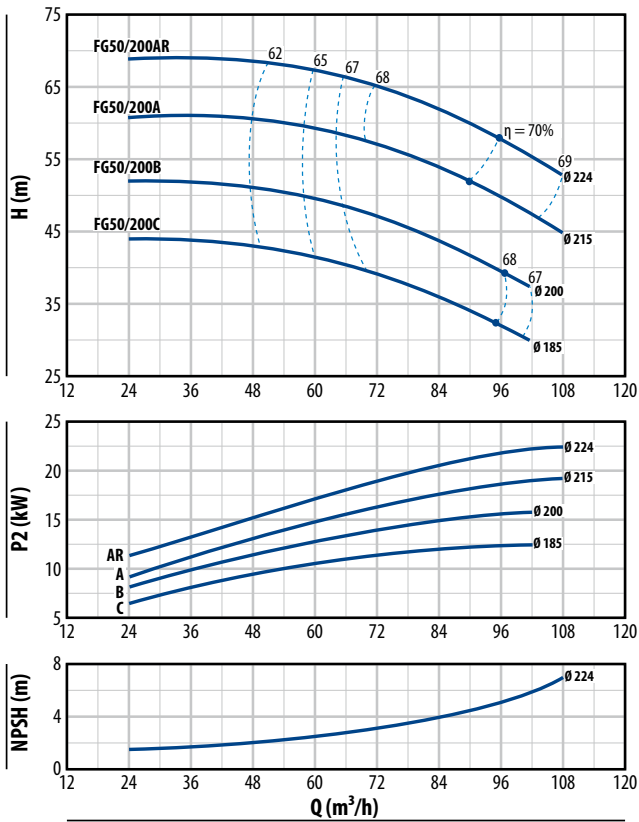

FG2 50/250

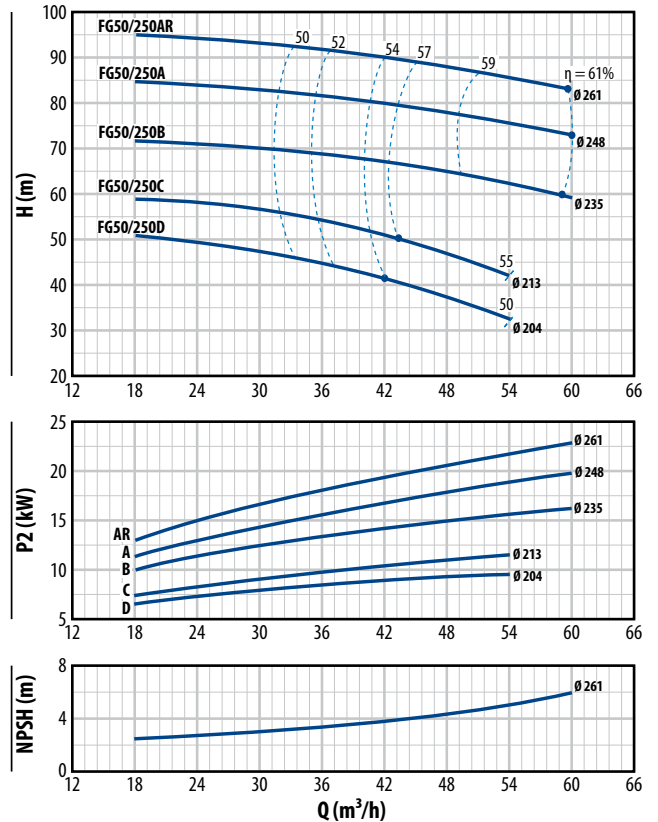

FG2 65/125

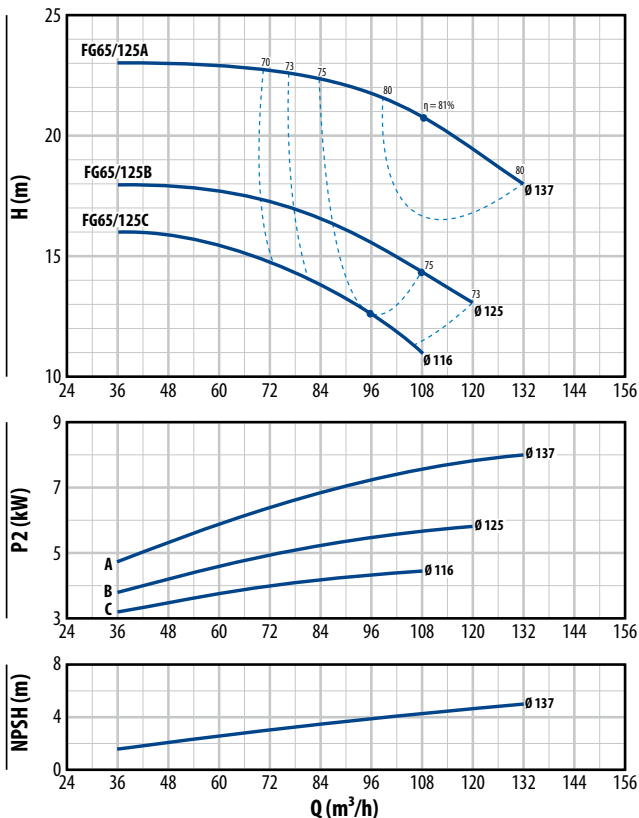

FG2 65/160

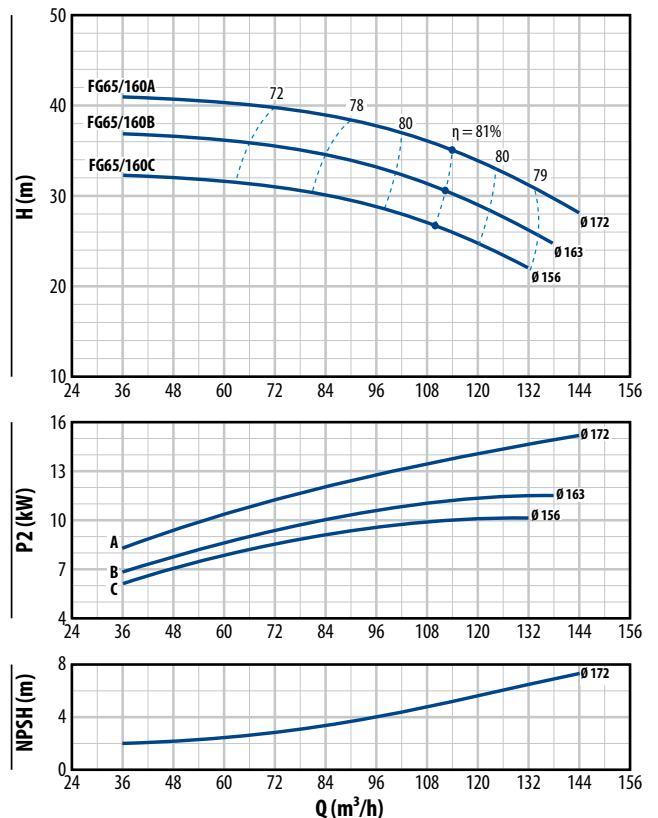

COURBES DE PERFORMANCE

HS = 0 m

FG2 65/200

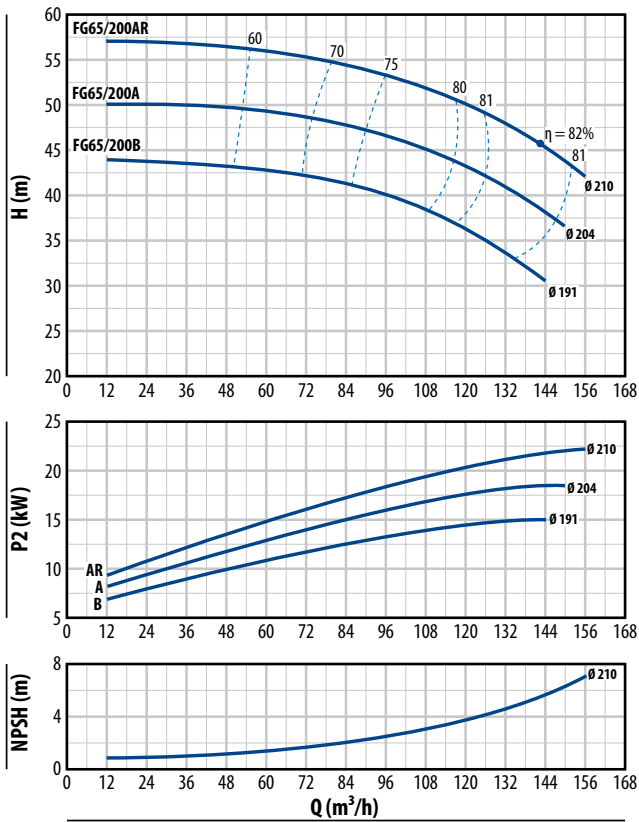

FG2 65/250

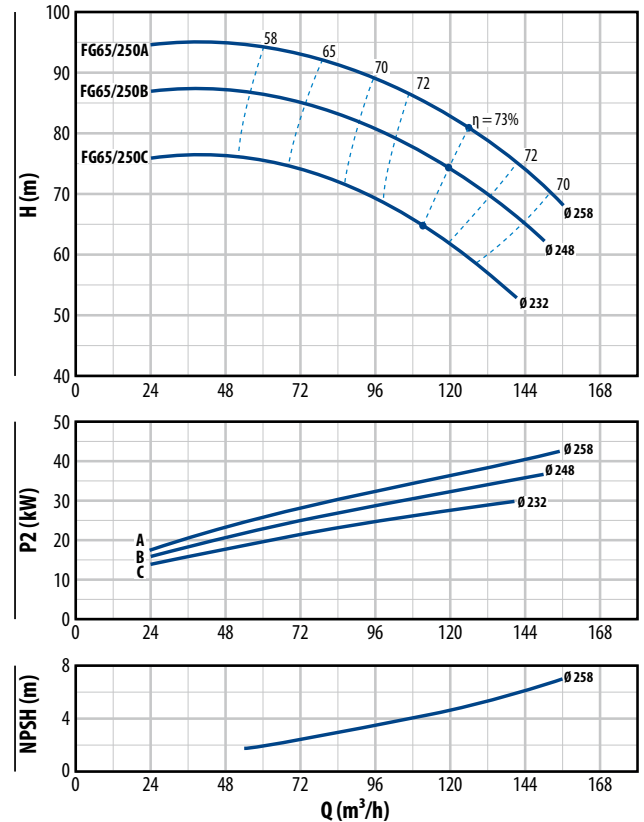

FG2 80/160

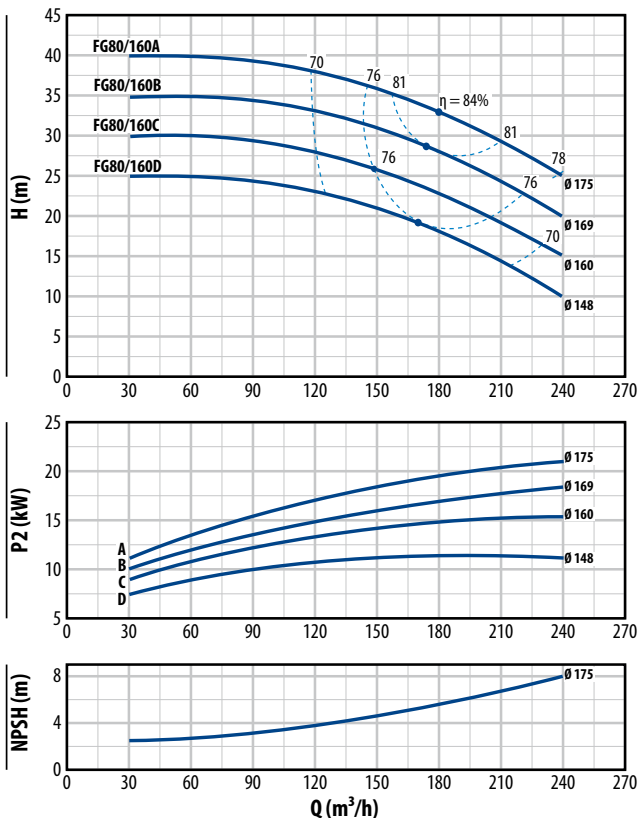

FG2 80/200

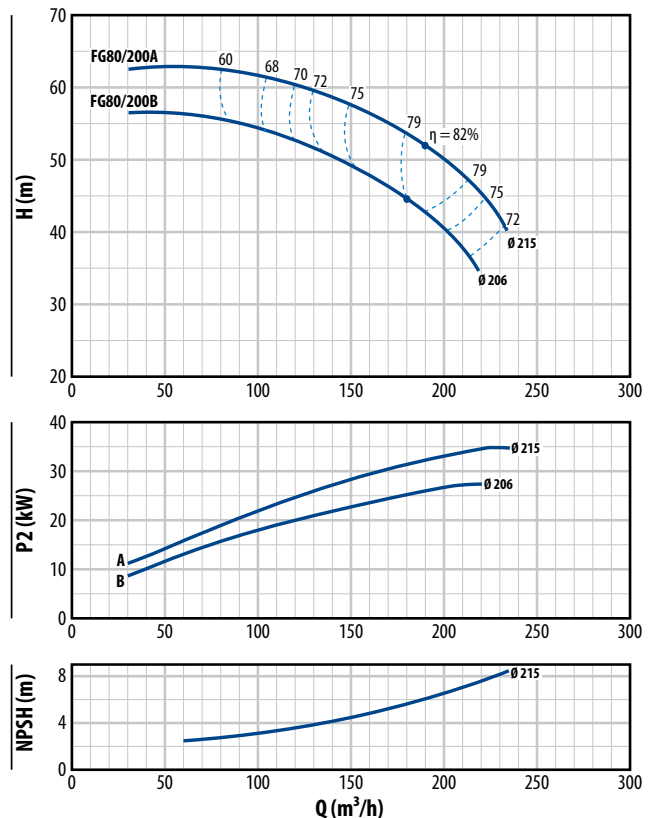

COURBES DE PERFORMANCE

HS = 0 m

FG2 80/250

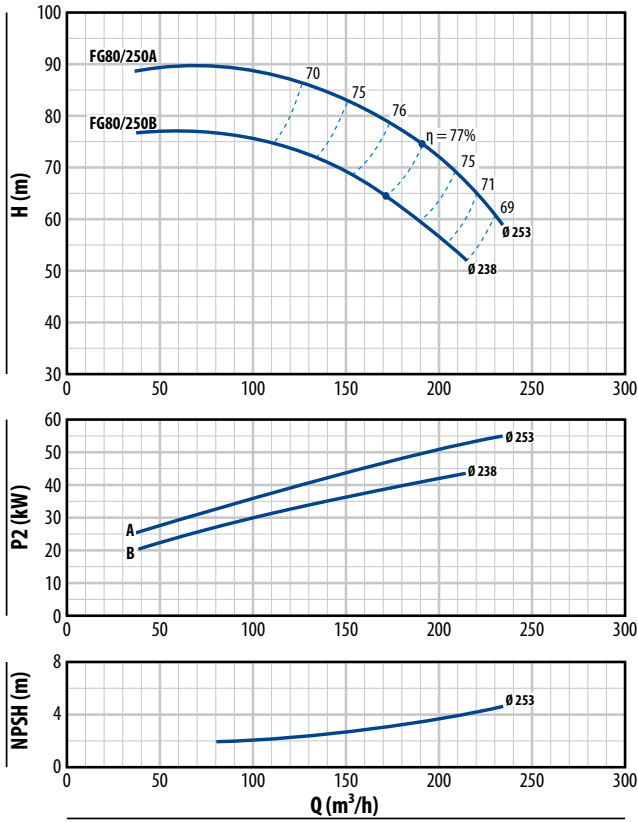

FG2 100/160

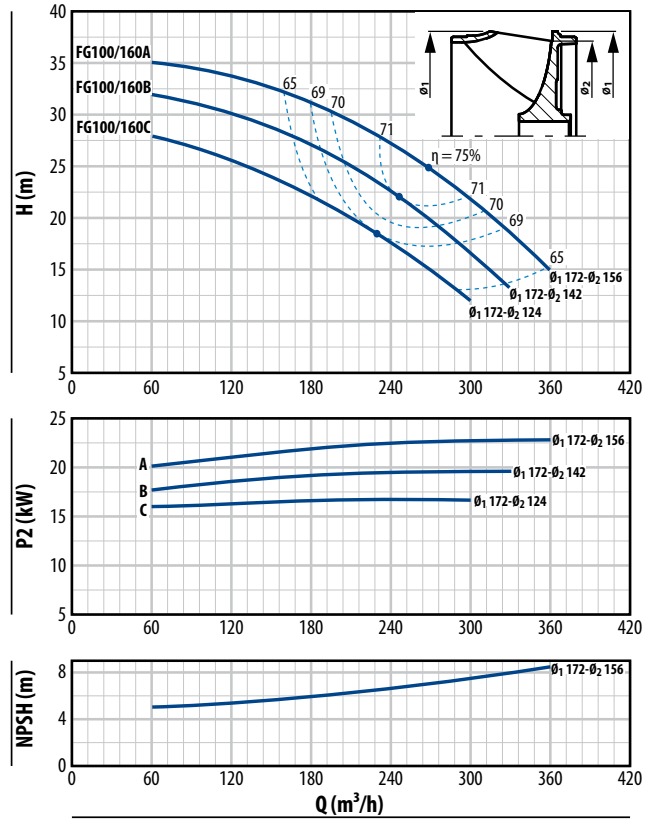

FG2 100/200

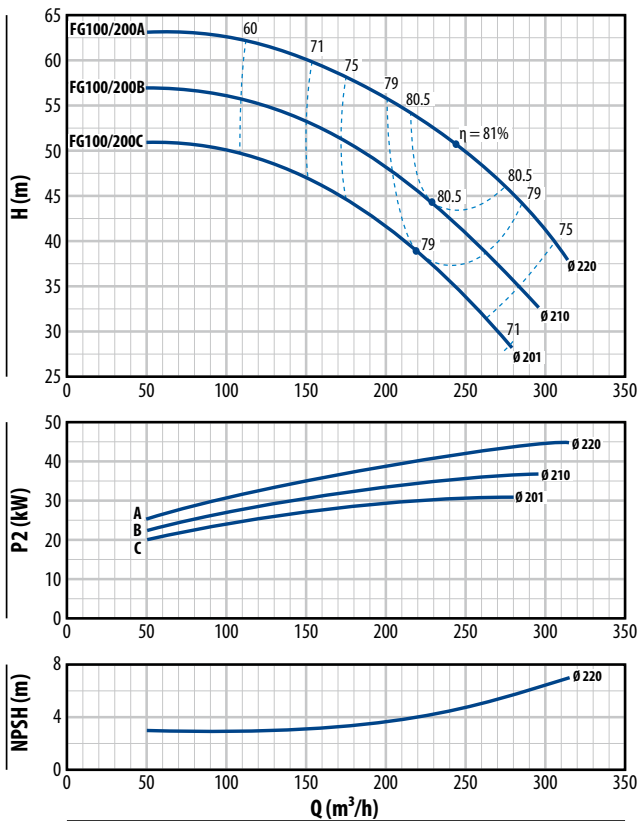

FG2 100/250

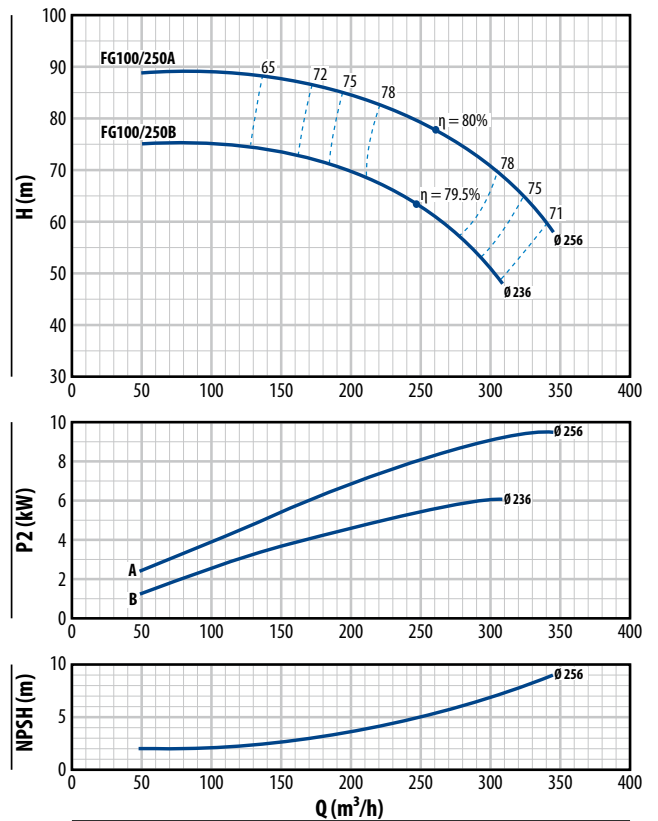

PLAGE DES PERFORMANCES

HS = 0 m

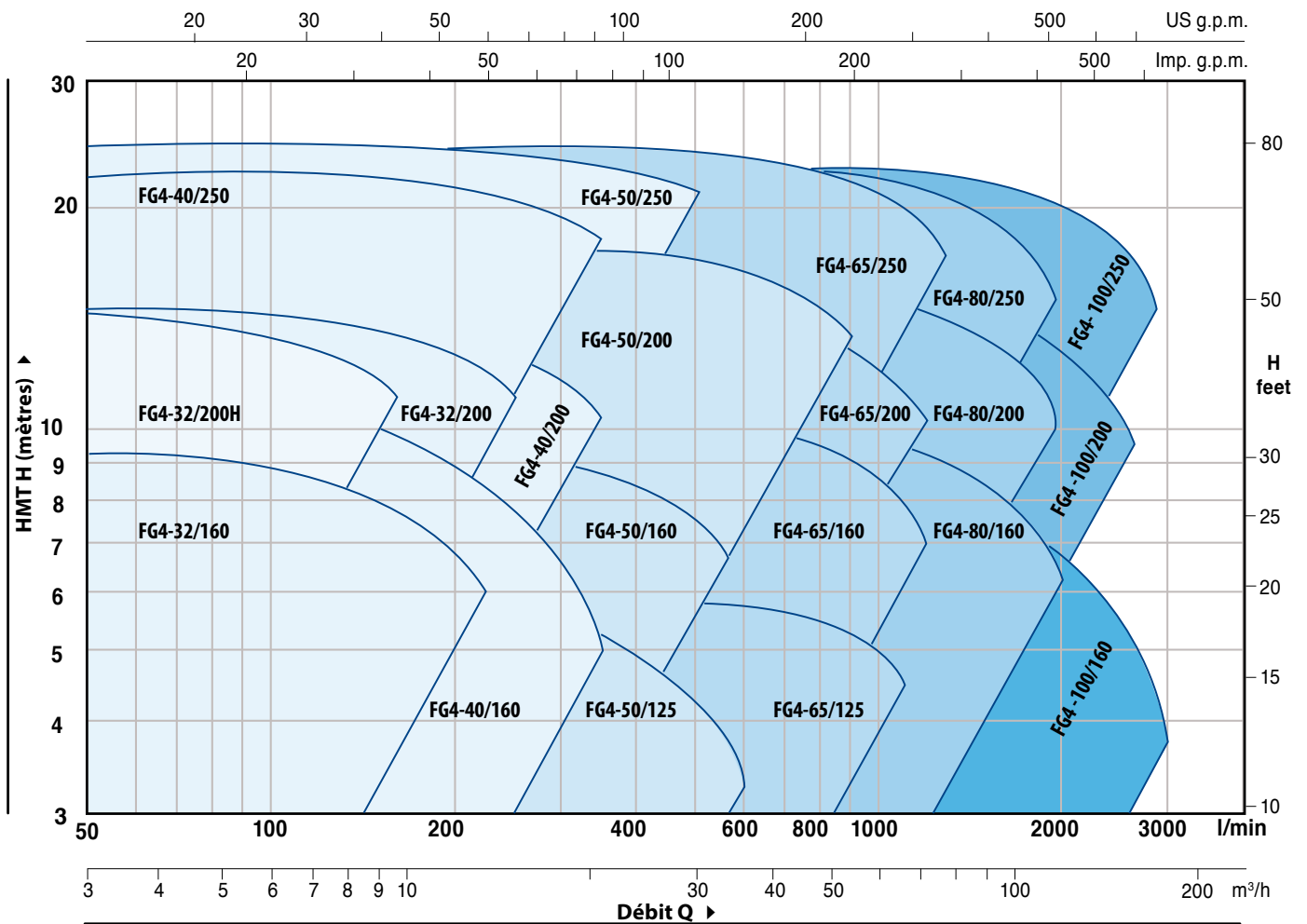

CARACTÉRISTIQUES DE PERFORMANCE

HS = 0 m

TYPE	MOTEUR À ACCOUPLER		PERFORMANCES	
	kW	HP	Q m³/h	H mètres
pompe				
FG4 32/160B	0.37	0.5	3 ÷ 12	7.5 ÷ 4
FG4 32/160A	0.37	0.5	3 ÷ 13.5	9 ÷ 6
FG4 32/200C	0.55	0.75	3 ÷ 13.5	11 ÷ 8
FG4 32/200B	0.75	1	3 ÷ 15	12.5 ÷ 9
FG4 32/200A	1.1	1.5	3 ÷ 15	14 ÷ 11
FG4 32/200BH	0.55	0.75	3 ÷ 9	11 ÷ 9
FG4 32/200AH	0.55	0.75	3 ÷ 9.6	13.5 ÷ 11
FG4 40/160C	0.37	0.5	3 ÷ 18	6.5 ÷ 3.5
FG4 40/160B	0.37	0.5	3 ÷ 18	8 ÷ 5
FG4 40/160A	0.55	0.75	3 ÷ 21	9.5 ÷ 5
FG4 40/200B	0.75	1	3 ÷ 21	11.5 ÷ 7
FG4 40/200A	1.1	1.5	3 ÷ 21	13.5 ÷ 10
FG4 40/250C	1.1	1.5	3 ÷ 21	16 ÷ 11.5
FG4 40/250B	1.5	2	3 ÷ 21	17.5 ÷ 13.5
FG4 40/250A	2.2	3	3 ÷ 21	22 ÷ 18
FG4 50/125C	0.37	0.5	9 ÷ 36	4 ÷ 1.5
FG4 50/125B	0.55	0.75	9 ÷ 36	5 ÷ 2
FG4 50/125A	0.55	0.75	9 ÷ 36	6 ÷ 3
FG4 50/160C	0.55	0.75	9 ÷ 30	7 ÷ 4
FG4 50/160B	0.75	1	9 ÷ 33	8 ÷ 5
FG4 50/160A	1.1	1.5	9 ÷ 33	9 ÷ 7
FG4 50/200C	1.5	2	12 ÷ 51	11 ÷ 7.5
FG4 50/200B	2.2	3	12 ÷ 51	13 ÷ 9.5
FG4 50/200A	2.2	3	12 ÷ 54	15 ÷ 11
FG4 50/200AR	3	4	12 ÷ 54	17 ÷ 13
FG4 50/250D	1.1	1.5	9 ÷ 27	12.5 ÷ 8
FG4 50/250C	1.5	2	9 ÷ 27	14.5 ÷ 10.5
FG4 50/250B	2.2	3	9 ÷ 30	18 ÷ 14.5
FG4 50/250A	2.2	3	9 ÷ 30	21 ÷ 18
FG4 50/250AR	3	4	9 ÷ 30	24 ÷ 21

TYPE	MOTEUR À ACCOUPLER		PERFORMANCES	
	kW	HP	Q m³/h	H mètres
pompe				
FG4 65/125B	0.75	1	18 ÷ 60	4.5 ÷ 3
FG4 65/125A	1.1	1.5	18 ÷ 66	5.5 ÷ 4.5
FG4 65/160C	1.1	1.5	18 ÷ 66	8 ÷ 5.5
FG4 65/160B	1.5	2	18 ÷ 72	9 ÷ 5.5
FG4 65/160A	2.2	3	18 ÷ 72	10 ÷ 7
FG4 65/200B	2.2	3	6 ÷ 72	11 ÷ 8
FG4 65/200A	2.2	3	6 ÷ 78	12.5 ÷ 9
FG4 65/200AR	3	4	6 ÷ 78	14.3 ÷ 10.5
FG4 65/250C	3	4	12 ÷ 70.5	19 ÷ 13
FG4 65/250B	4	5.5	12 ÷ 75	21.5 ÷ 15.5
FG4 65/250A	5.5	7.5	12 ÷ 78	23.5 ÷ 17
FG4 80/160D	1.5	2	15 ÷ 120	6 ÷ 2.5
FG4 80/160C	2.2	3	15 ÷ 120	7.5 ÷ 3.5
FG4 80/160B	2.2	3	15 ÷ 120	8.5 ÷ 5
FG4 80/160A	3	4	15 ÷ 120	10 ÷ 6
FG4 80/200B	4	5.5	15 ÷ 109.5	14 ÷ 8.5
FG4 80/200A	5.5	7.5	15 ÷ 117	15.5 ÷ 10
FG4 80/250B	5.5	7.5	18 ÷ 108	19 ÷ 13.5
FG4 80/250A	7.5	10	18 ÷ 117	22 ÷ 15
FG4 100/160C	2.2	3	30 ÷ 150	7 ÷ 3
FG4 100/160B	3	4	30 ÷ 165	8 ÷ 3
FG4 100/160A	3	4	30 ÷ 180	8.5 ÷ 3.5
FG4 100/200C	4	5.5	24 ÷ 139.5	12.5 ÷ 7
FG4 100/200B	5.5	7.5	24 ÷ 147	14 ÷ 8
FG4 100/200A	5.5	7.5	24 ÷ 157.5	15.5 ÷ 9.5
FG4 100/250B	7.5	10	24 ÷ 154.5	18.5 ÷ 12
FG4 100/250A	9.2	12.5	24 ÷ 172.5	22 ÷ 14.5

FG4 32/160

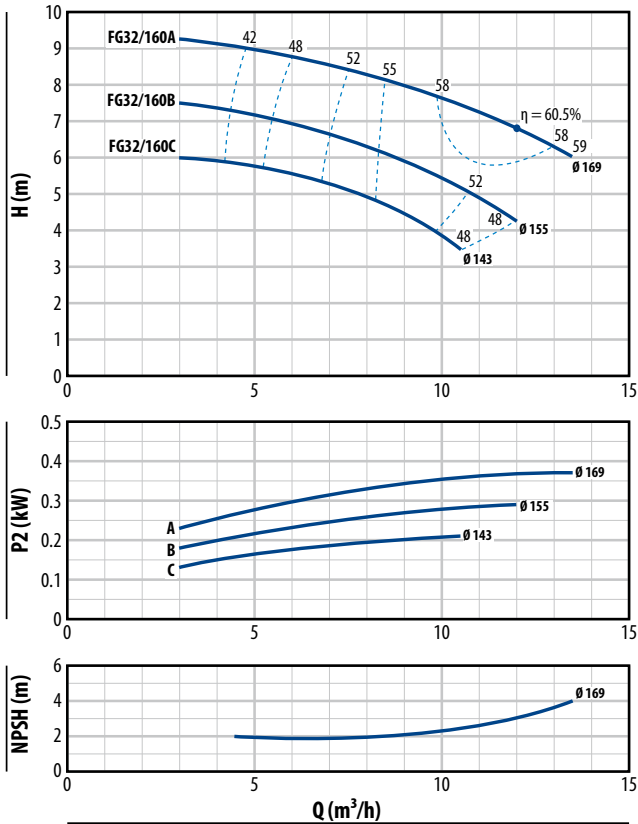

FG4 32/200

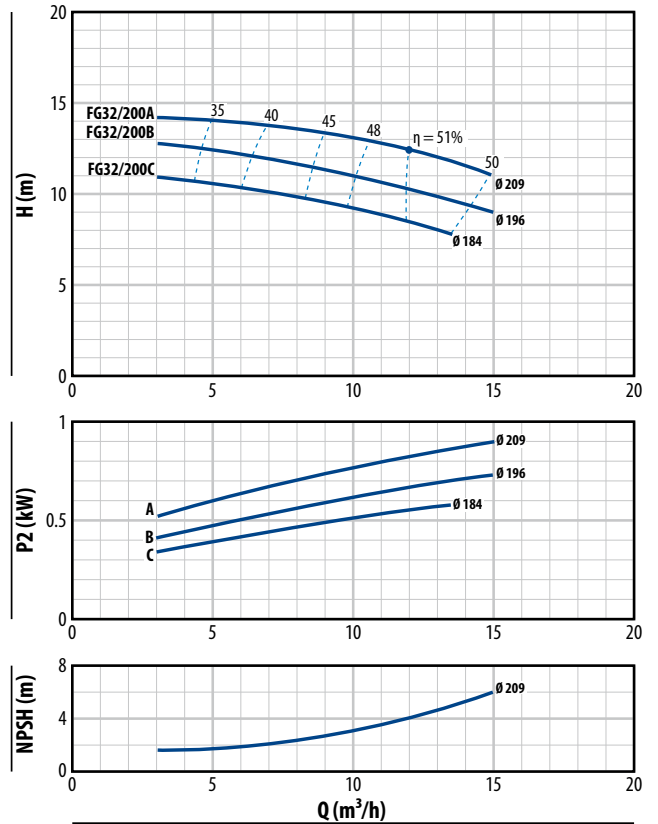

FG4 32/200H

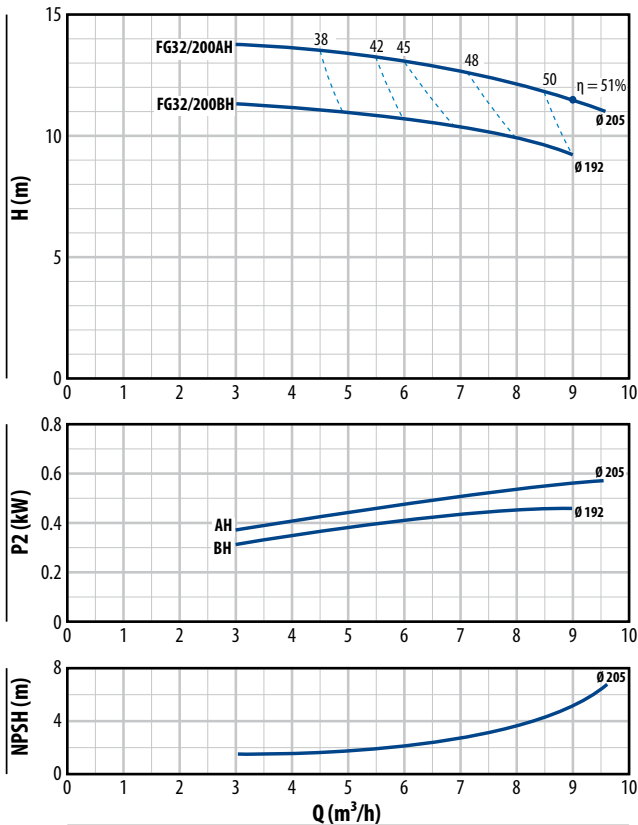

FG4 40/160

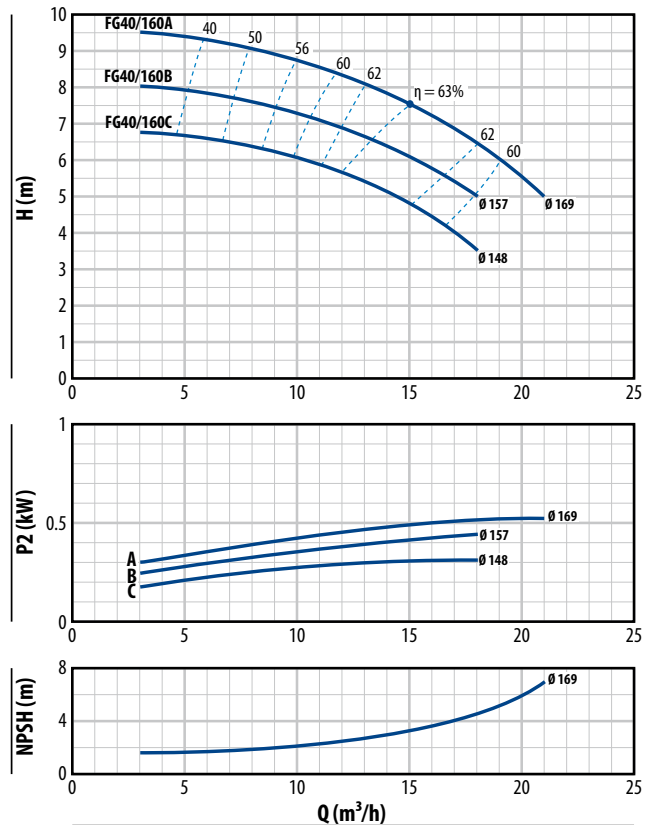

COURBES DE PERFORMANCE

HS = 0 m

FG4 40/200

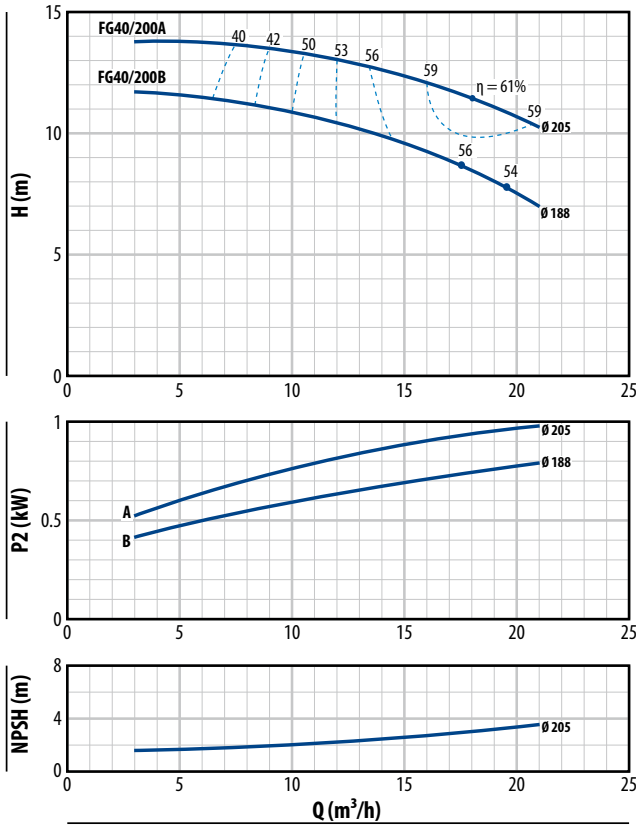

FG4 40/250

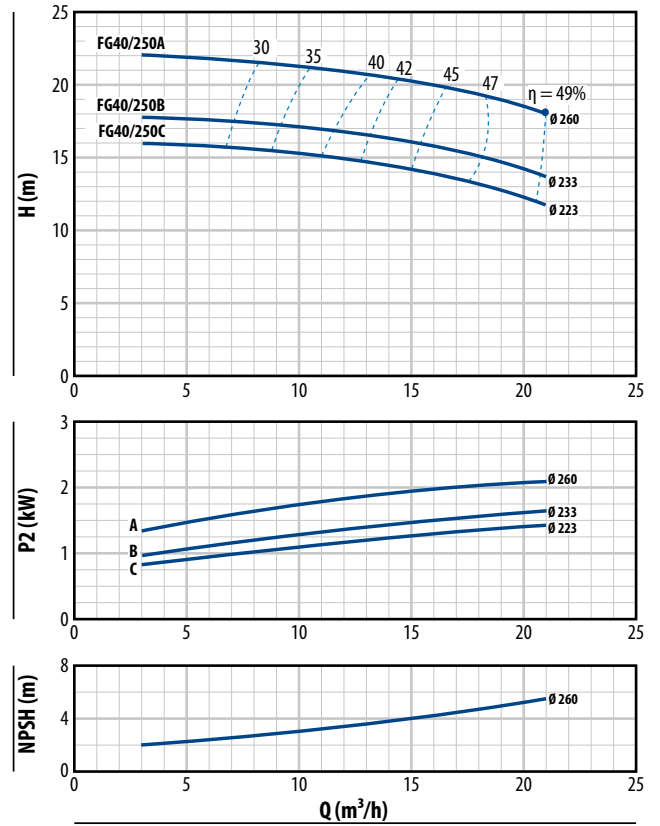

FG4 50/125

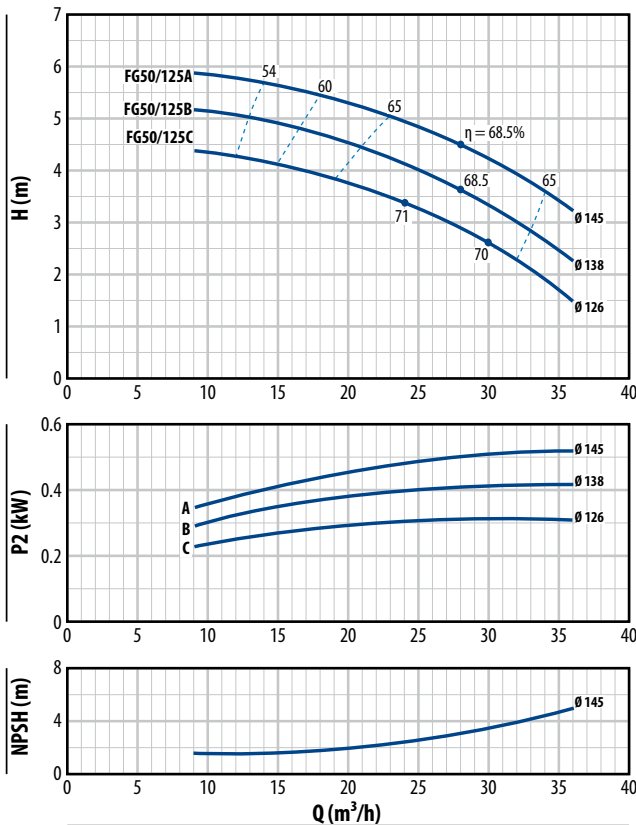

FG4 50/160

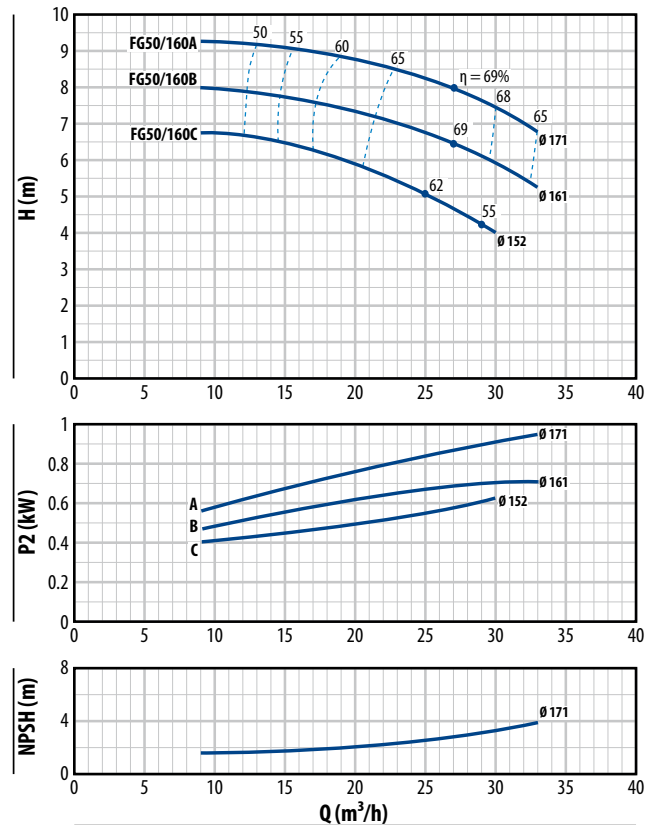

FG4 50/200

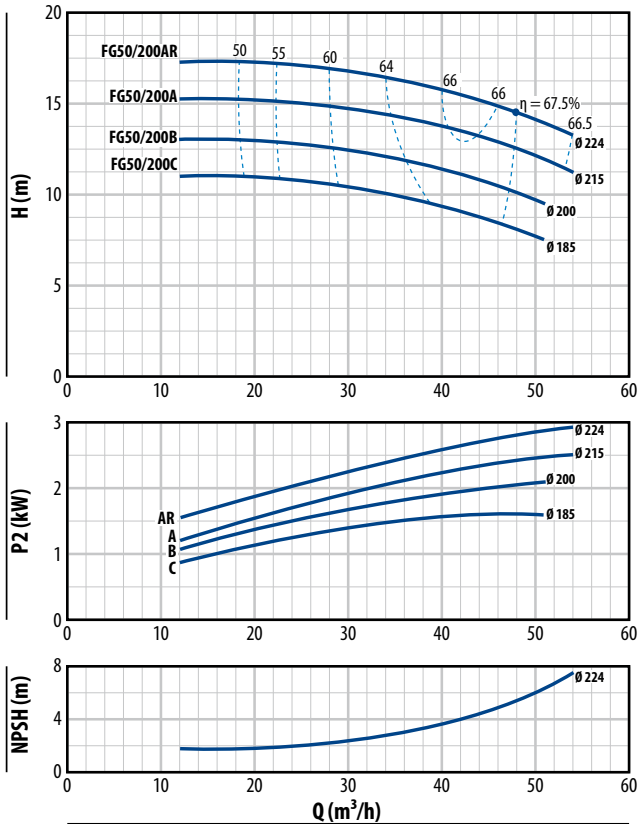

FG4 50/250

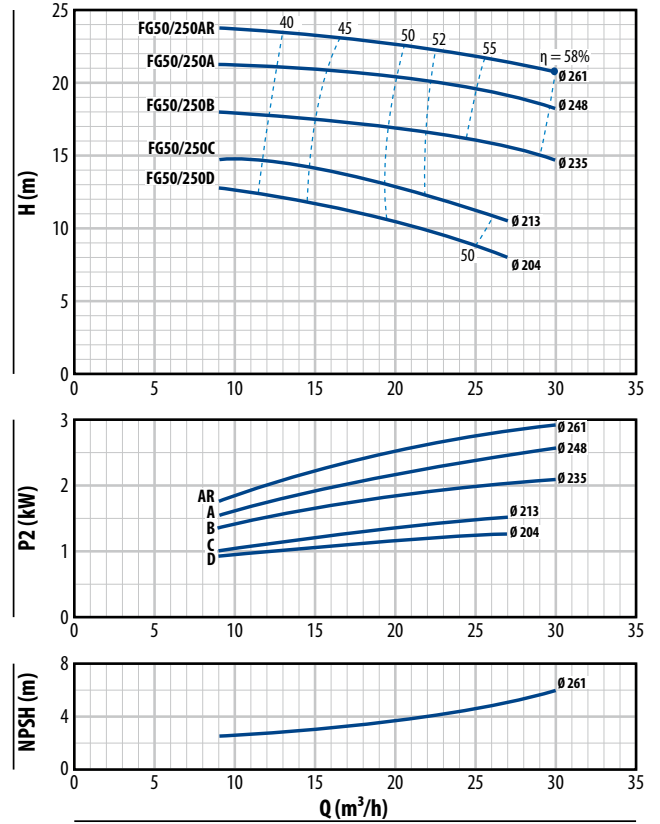

FG4 65/125

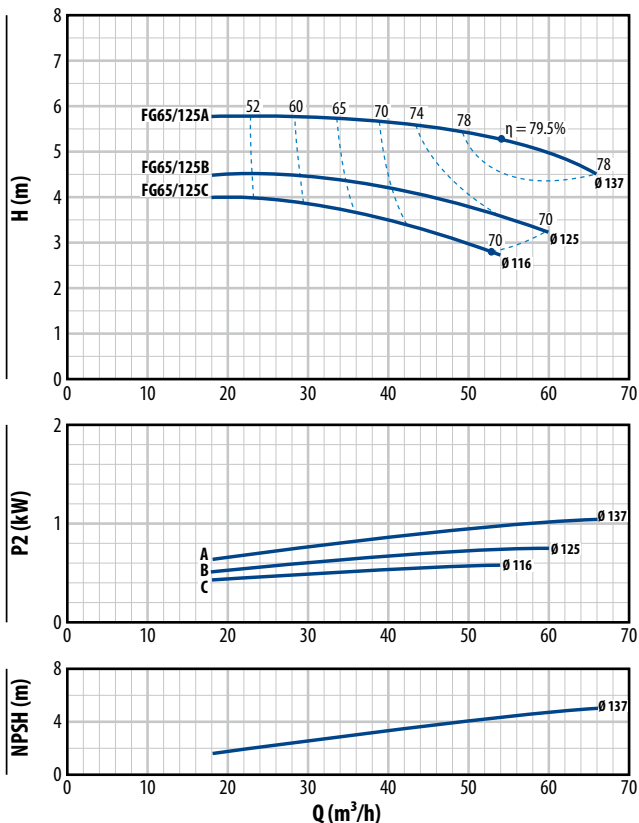

FG4 65/160

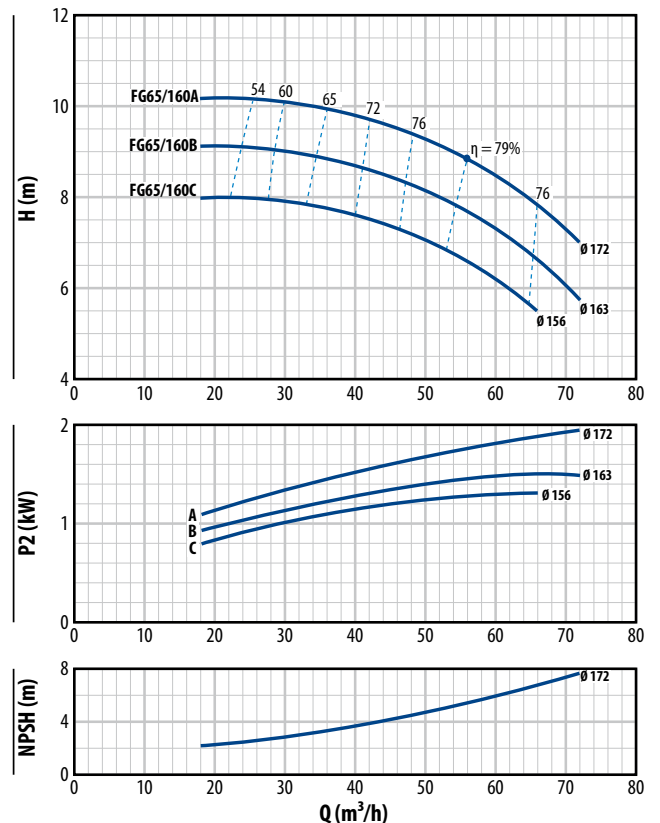

COURBES DE PERFORMANCE

HS = 0 m

FG4 65/200

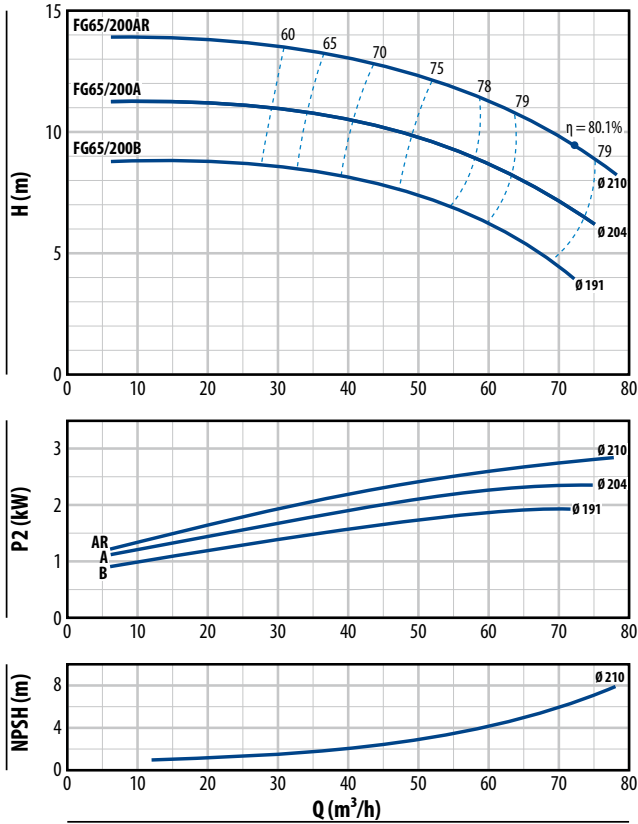

FG4 65/250

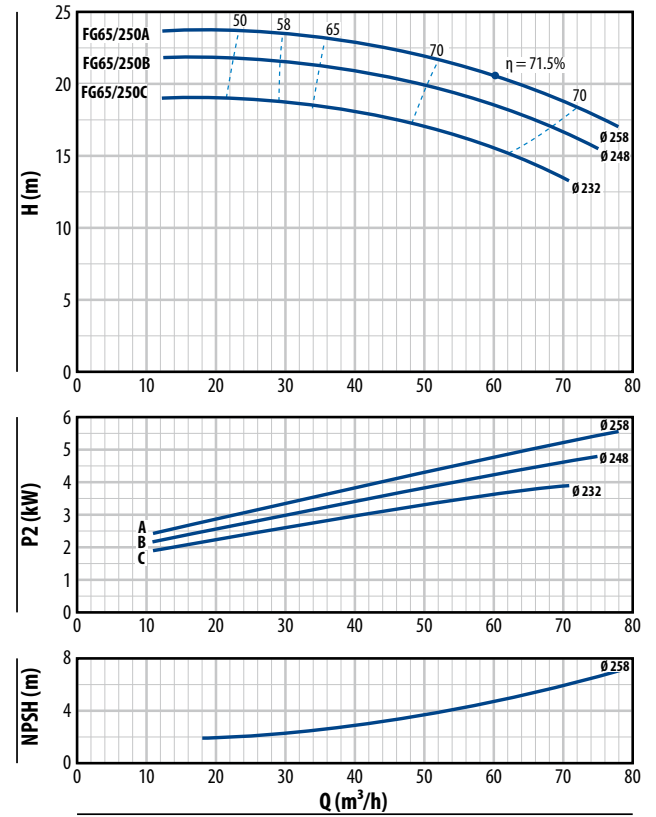

FG4 80/160

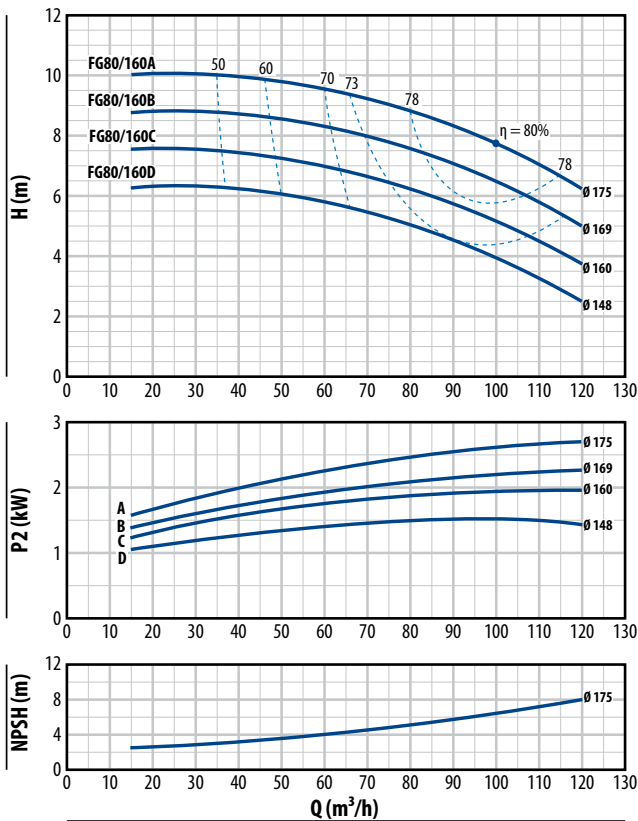

FG4 80/200

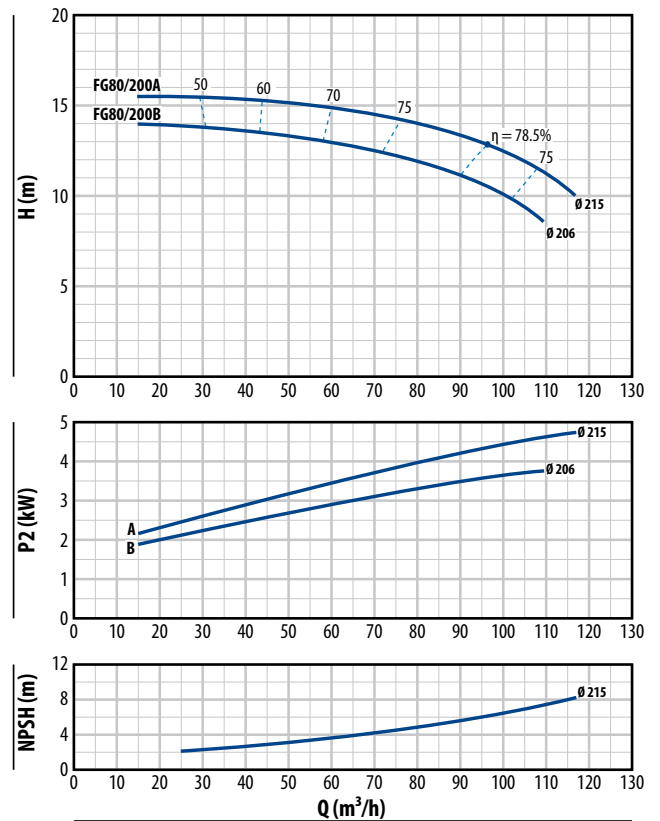

COURBES DE PERFORMANCE

HS = 0 m

FG4 80/250

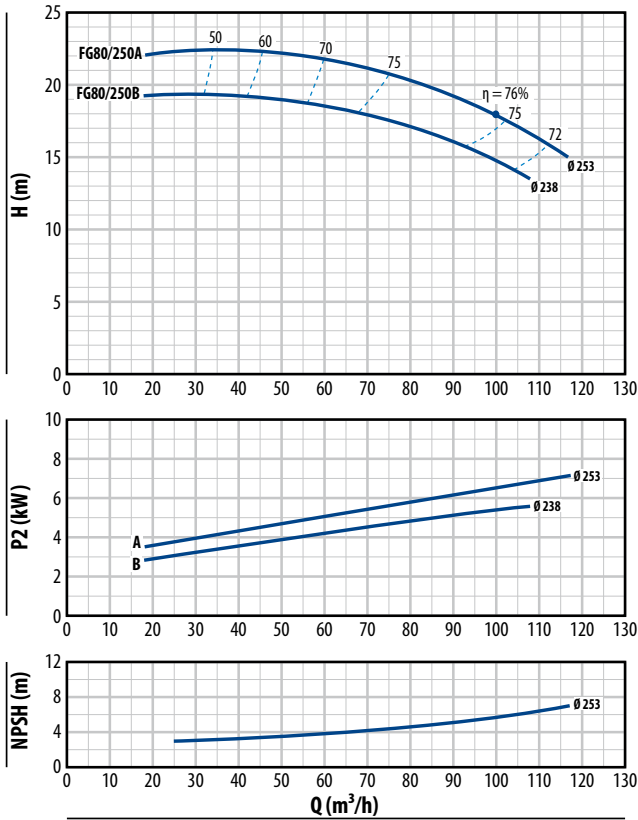

FG4 100/160

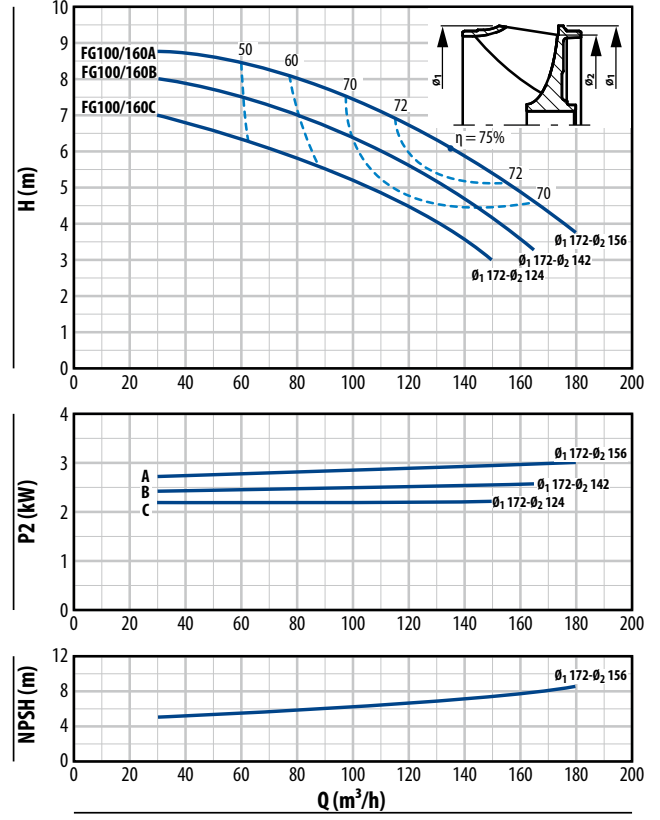

FG4 100/200

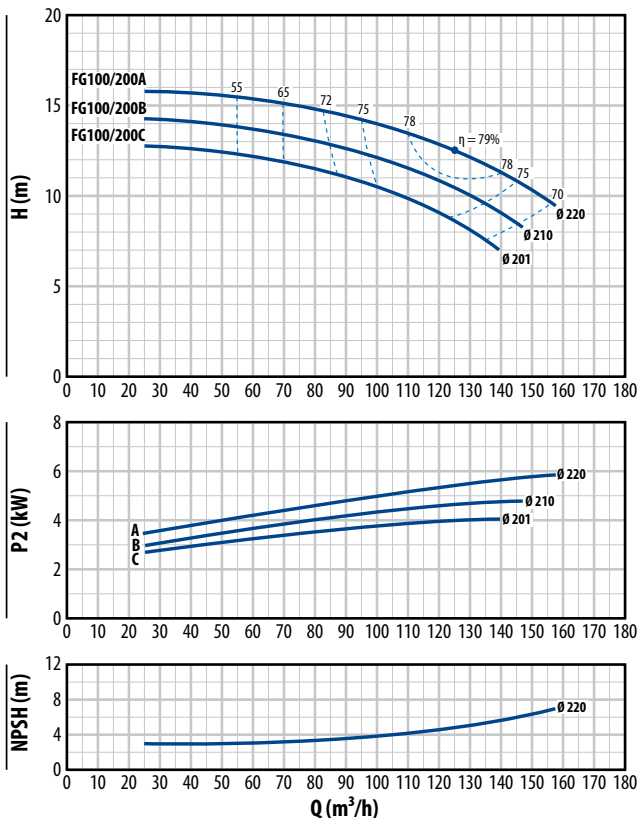

FG4 100/250

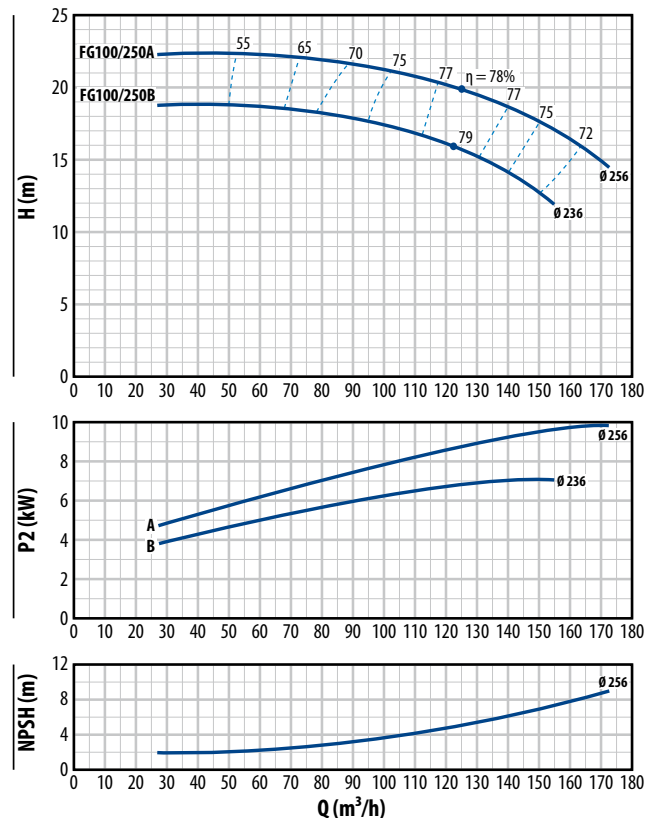

DIMENSIONS ET POIDS

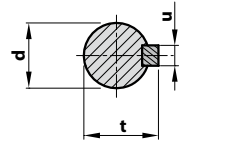
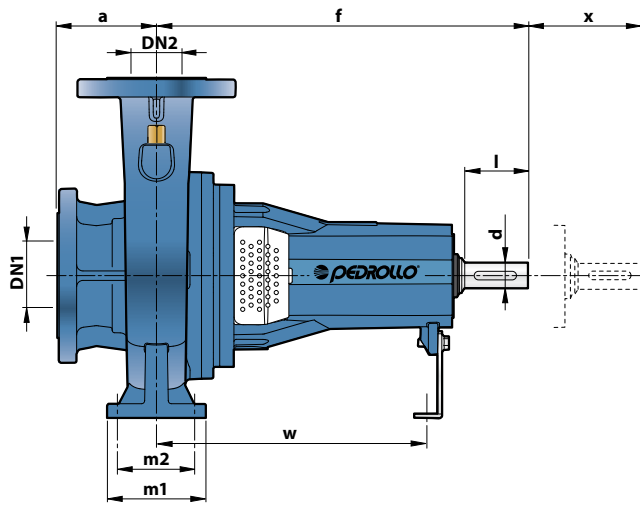

EXTRÉMITÉ ARBRE
mm

d	u	t
24 k6	8	27
32 k6	10	35

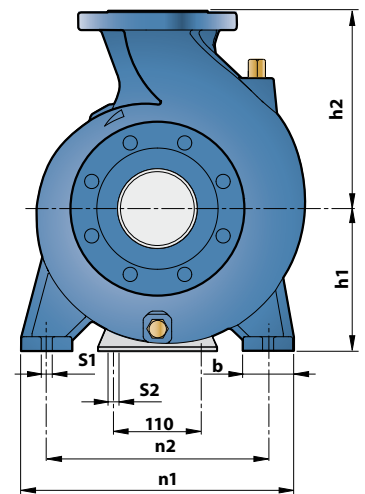

DN BRIDES	D mm	K mm	TROUS	
			N°	Ø (mm)
32	140	100	4	18
40	150	110		
50	165	125		
65	185	145		
80	200	160	8	18
100	220	180		
125	250	210		

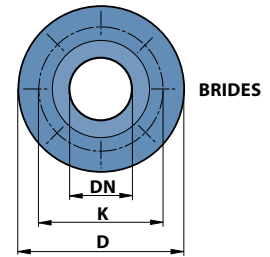

TYPE	ORIFICES		DIMENSIONS mm														kg										
	DN1	DN2	a	f	h1	h2	b	m1	m2	n1	n2	s1	s2	w	x	d		l									
FG 32/160	50	32	80	360	132	160	50	100	70	240	190	14	260	100	24	50	32	80	32								
FG 32/200					160	180	55	95											35								
FG 32/200H					160	180	55	100											35								
FG 40/160	65	40	100	360	132	160	50	100	70	265	212	14	260	100	24	50	32	80	35								
FG 40/200					160	180	55	100											38								
FG 40/250					180	225	65	125											95	320	250	58					
FG 50/125	65	50	100	360	132	160	50	100	70	240	190	14	260	100	24	50	32	80	30								
FG 50/160					160	180	55	100											35								
FG 50/200					160	200	50	100											45								
FG 50/250	80	65	100	360	180	225	65	125	95	320	250	14	260	100	24	50	32	80	50								
FG 65/125					160	180	65	125											42								
FG 65/160					160	200	65	125											45								
FG 65/200	80	65	100	360	180	225	65	125	95	320	250	14	260	100	24	50	32	80	50								
FG 65/250					470	200	250	80											160	120	360	280	18	340	32	80	71
FG 80/160					360	180	225	65											125	95	320	250	14	260	24	50	48
FG 80/200	100	80	125	360	180	250	65	125	95	345	280	14	340	140	32	80	32	80	65								
FG 80/250					470	200	280	80											160	120	400	315	18	340	32	80	79
FG 100/160	125	100	140	360	200	280	80	160	120	360	280	18	340	140	24	50	32	80	55								
FG 100/200					200	280	80	160											120	360	280	18	340	32	80	75	
FG 100/250					225	280	80	160											120	400	315	18	340	32	80	88	