

**50/60 Hz**



# ecocirc® PREMIUM Series

WET ROTOR CIRCULATORS FOR  
HEATING, COOLING AND SANITARY SYSTEMS

**ErP 2009/125/EC**

Cod. 191007301 Rev.A Ed.01/2014

 **LOWARA**  
a xylem brand

**ecocirc® PREMIUM SERIES  
INSTALLATION POSITIONS**

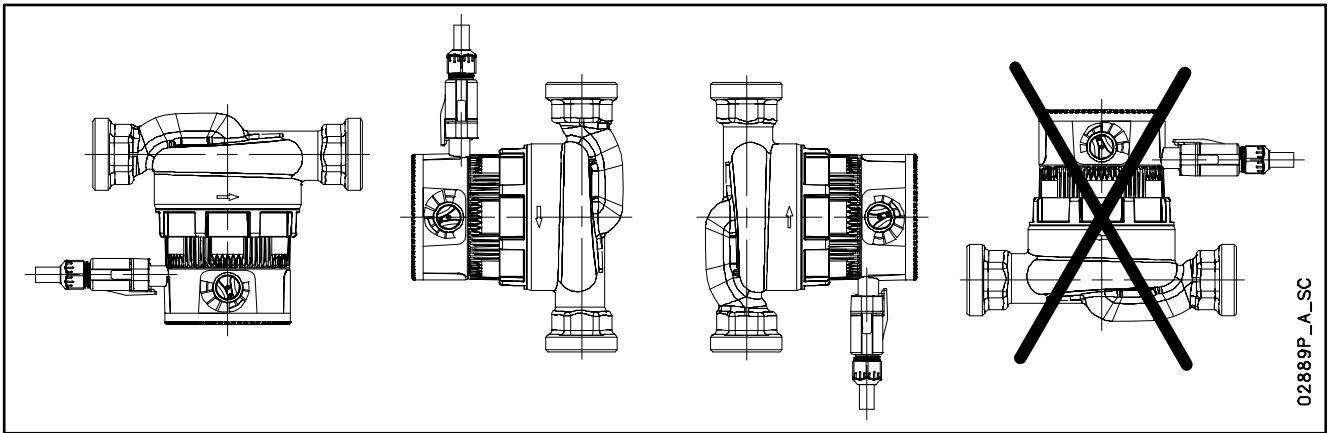

## High efficiency circulators for domestic heating

### ecocirc® PREMIUM Series

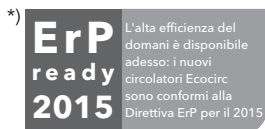

### MARKET SECTORS

RESIDENTIAL.

### APPLICATIONS

- Water circulation in heating and air conditioning systems.
- Refurbishment or extension of existing systems.
- Recommended for facilities fitted with thermostatic valves.
- Single-family houses or apartment buildings.
- Floor heating systems.

### SPECIFICATIONS

#### PUMP



- **Flow rate:** up to 3,2 m<sup>3</sup>/h.
- **Head:** up to 5,7 m.
- **Maximum power consumption:** 23 W (for the 4 m model) and 42 W (for the 6 m model).
- **Temperature of pumped liquid:** -10°C ÷ +110°C.  
Avoid condensation and ice formation.  
Maximum 20% glycol and water mixture.  
For glycol quantities higher than 20%, hydraulic performances must be checked.
- **Maximum operating pressure:** 10 bar (PN 10).
- **Rotor assembly group:** made of stainless steel/composite material/carbon.

#### MOTOR

- Permanent magnet EC (Electronically Commutated) type motor with spherical rotor/stator.
- Wet rotor with a single spherical ceramic/carbon bearing.
- Integrated motor protection; no external protection required.
- Single-phase 200-240 V 50/60 Hz power supply.
- Variable-speed motor, with automatic speed adjustment based on system requirement.
- **Insulation class** F (155°C).
- **Protection class** IP 44.

\*) model 15-6/130 excluded.

## ecocirc® PREMIUM CONSTRUCTION CHARACTERISTICS Series

- **Improved hydraulics to improved efficiency.**  
The cast iron pump housing is cathaphoresis coated completely and is therefore resistant to corrosion.
- **The spherical rotor.** The permanent magnet rotor/impeller unit is the only moving part. Spherical motor pumps are shaftless, and therefore whisper quiet over the whole lifetime. In case of an indicated rotor blocking, emergency software shakes and vibrates the rotor to avoid further blocking.
- **Anti-Block-Technology** allows to separate the magnetic chamber from the flow, preventing magnetite and sludge to block and damage the pump. Blocking up, even in very old, open systems is impossible by our pump design.
- **Three in one control:**
  -  step-less manually control constant speed, (displayed by a white LED),
  -  automatic differential pressure, (displayed by a blue LED),
  -  automatic constant pressure, (displayed by a green LED).
- **Digital multi-Display** that shows automatically and alternatively power consumption (Watt), head (m), and flow-rate (m<sup>3</sup>/h). The display provides also detailed information on the air purge mode status as well as detailed error messages.
- **Optimized motor technology:** Doubled electric windings combined with the latest 32 Bit processor technology - that also makes the Ecocirc® even more efficient.
- **Overtemperature protection feature** that slows down the circulator in case the temperature of the electronic module is too high and shuts it down when temperature rises above the safety limit. The circulator will automatically restart after having cooled down.
- Always **easy to access:** The screw ring design results in a pump motor that can be rotated in any position around the 360° circle. The electrical connection as well as the control knob is therefore easy to access.
- **Plug** an easy and quick electrical connection. By turning the stator via the screw ring the plug can be fixed in any position, making the installation even in the hardest and tightest environment easy.
- **Automatic air purge:** Quick automatic air-venting-mode for a safe operation.
- According to EN standards 60335-1, 60335-2-51, 55014-1, 55014-2, 16297-1, 16297-2.

### CONTROL MODES

- Automatic regulation: the pump automatically adjusts the working conditions based on the requirement of the system. When the pump detects a decrease in the flow, the inverter reduces the differential pressure of the pump until it reaches the required head.

### ACCESSORIES

- Pipe unions.
- Insulation shell.

### INSTALLATION

- Suitable for installation in vertical or horizontal piping, in this last case not with the motor housing upward.

## ecocirc® PREMIUM SERIES IDENTIFICATION CODE

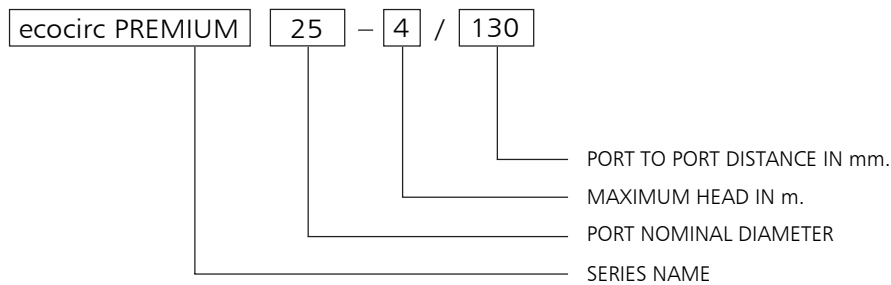

EXAMPLE : ecocirc PREMIUM 25-4/130

Electronic circulator of the ecocirc PREMIUM series, port nominal diameter = 25, max head = 4 m, with port to port distance 130 mm.

## TABLE OF MATERIALS

PART	MATERIAL
Pump body	Cast iron ( EN-GJL-200 ) cataphoretically coated
Rotor assembly group	Stainless steel
	Composite material
	Carbon
Bearing	Ceramics
Gaskets	EPDM Rubber
Motor housing	Aluminum ( AlSi11Cu2 )
Screw ring	Aluminum ( AlMgSi05 )
Plug	Polyamide

ecocircP-50-en\_a\_tm

### Regulations (EC) n. 641/2009 and (EU) n. 622/2012 – Annex I – point 2 (Product information requirements)

- Energy efficiency index: see the EEI column in the tables in the Hydraulic performance section.
- "The benchmark for most efficient circulators is  $EEI \leq 0,20$ ".
- Information relevant for disassembly, recycling or disposal at end-of-life: observe the current laws and by-laws governing sorted waste disposal. Consult the product operating manual.
- Information for circulators specifically designed to potable water uses: note not applicable to these products.

## ecocirc® PREMIUM...4/ SERIES HYDRAULIC PERFORMANCE TABLES

### (CONSTANT SPEED) (CONSTANT PRESSURE)

PUMP TYPE ecocirc PREMIUM 230V 50Hz	EEI ≤ (1)	POWER ABSORBED		SPEED	Q = DELIVERY											
		MIN W	MAX W		l/s 0	0,06	0,11	0,17	0,22	0,28	0,31	0,44	0,56	0,69		
					m <sup>3</sup> /h 0	0,2	0,4	0,6	0,8	1,0	1,1	1,6	2,0	2,5		
H = TOTAL HEAD METRES COLUMN OF WATER																
15-4/130	0,22	4	23	min	0,5	0,4	0,4	0,4	0,3	0,2	0,2					
20-4/130	0,21															
25-4/130	0,21					max	3,6	3,4	3,1	2,9	2,7	2,5	2,4	1,8	1,3	0,5
25-4/180	0,21															
32-4/180	0,21															

Performances according to standards EN 16297-2.

(1) Energy efficiency index.

ecocircP4-c-50-en\_b\_th

### (PROPORTIONAL PRESSURE)

PUMP TYPE ecocirc PREMIUM 230V 50Hz	EEI ≤ (1)	POWER ABSORBED		CURRENT ABSORBED		SPEED	Q = DELIVERY											
		MIN W	MAX W	MIN A	MAX A		l/s 0	0,06	0,11	0,17	0,22	0,28	0,33	0,44	0,56	0,69		
							m <sup>3</sup> /h 0	0,2	0,4	0,6	0,8	1,0	1,2	1,6	2,0	2,5		
H = TOTAL HEAD METRES COLUMN OF WATER																		
15-4/130	0,22	4	23	0,09	0,28	min	0,52	0,53	0,52	0,49	0,45	0,43	0,39					
20-4/130	0,21																	
25-4/130	0,21							max	1,53	1,70	1,94	2,25	2,62	2,45	2,20	1,75	1,28	0,55
25-4/180	0,21																	
32-4/180	0,21																	

Performances according to standards EN 16297-2.

(1) Energy efficiency index.

ecocircP4-p-50-en\_b\_th

**ecocirc® PREMIUM...4/ SERIES**  
**SINGLE-PHASE OPERATING CHARACTERISTICS**

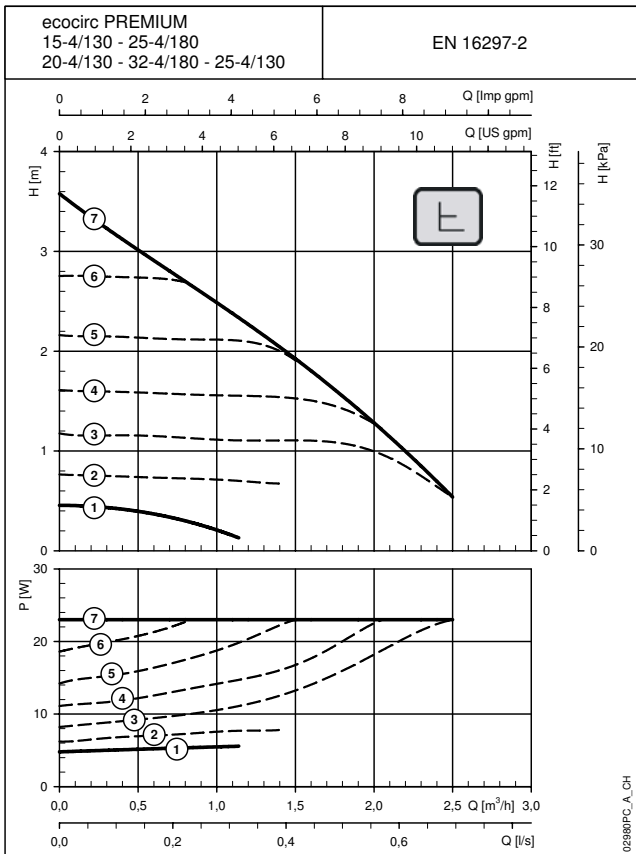
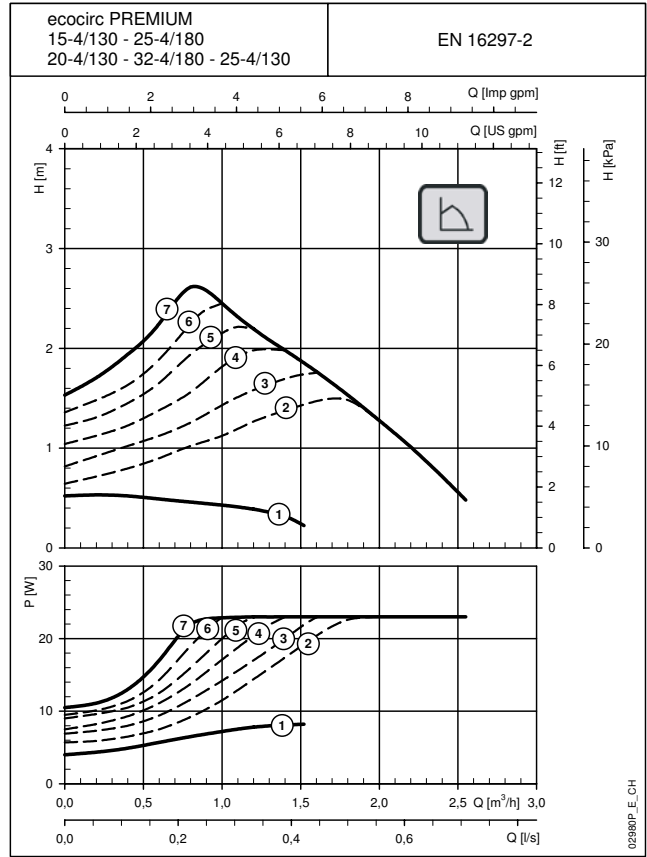
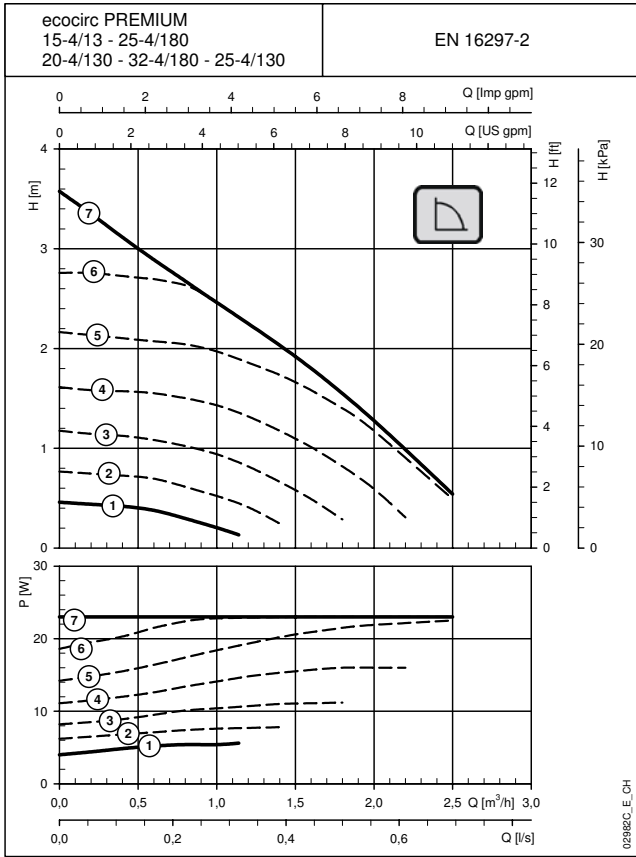

These performances are valid for liquids with density  $\rho = 1.0 \text{ Kg/dm}^3$  and kinematic viscosity  $\nu = 1 \text{ mm}^2/\text{sec}$ .  
Pump operates steplessly. Lines correspond to knob settings and are for reference only.

## ecocirc® PREMIUM...6/ SERIES HYDRAULIC PERFORMANCE TABLES

### (CONSTANT SPEED)

### (CONSTANT PRESSURE)

PUMP TYPE ecocirc PREMIUM 230V 50Hz	EEI ≤  (1)	POWER ABSORBED		SPEED	Q = DELIVERY													
		MIN	MAX		l/s 0	0,06	0,11	0,17	0,22	0,31	0,44	0,56	0,69	0,89				
		W	W		m <sup>3</sup> /h 0	0,2	0,4	0,6	0,8	1,1	1,6	2,0	2,5	3,2				
15-6/130	0,26*	4	42	min	0,5	0,5	0,4	0,4	0,3	0,1								
20-6/130	0,23																	
25-6/130	0,23																	
25-6/180	0,23					max	5,9	5,6	5,3	5,0	4,7	4,3	3,6	3,0	2,1	0,9		
32-6/180	0,23																	

Performances according to standards EN 16297-2.

(1) Energy efficiency index.

\* ErP ready 2013

ecocircP6-c-50-en\_b\_th

### (PROPORTIONAL PRESSURE)

PUMP TYPE ecocirc PREMIUM 230V 50Hz	EEI ≤  (1)	POWER ABSORBED		CURRENT ABSORBED		SPEED	Q = DELIVERY													
		MIN	MAX	MIN	MAX		l/s 0	0,06	0,11	0,17	0,22	0,28	0,42	0,56	0,69	0,83				
		W	W	A	A		m <sup>3</sup> /h 0	0,2	0,4	0,6	0,8	1,0	1,5	2,0	2,5	3,0				
15-6/130	0,26*	4	42	0,09	0,47	min	0,54	0,54	0,54	0,54	0,54	0,54	0,25							
20-6/130	0,23																			
25-6/130	0,23																			
25-6/180	0,23									max	2,86	3,09	3,38	3,70	4,05	4,38	3,70	2,95	2,15	1,25
32-6/180	0,23																			

Performances according to standards EN 16297-2.

(1) Energy efficiency index.

\* ErP ready 2013

ecocircP6-p-50-en\_b\_th



**ecocirc® PREMIUM...6/ SERIES**  
**SINGLE-PHASE OPERATING CHARACTERISTICS**

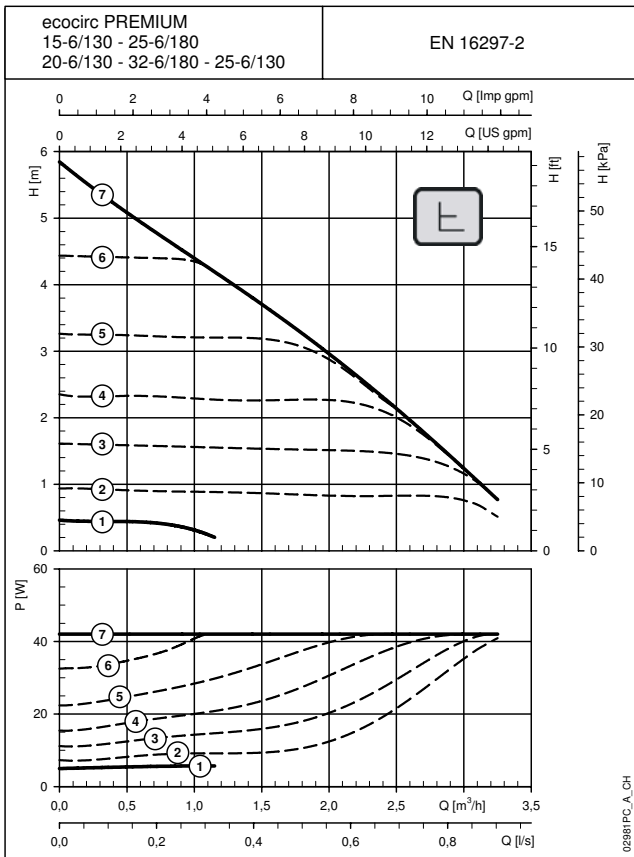
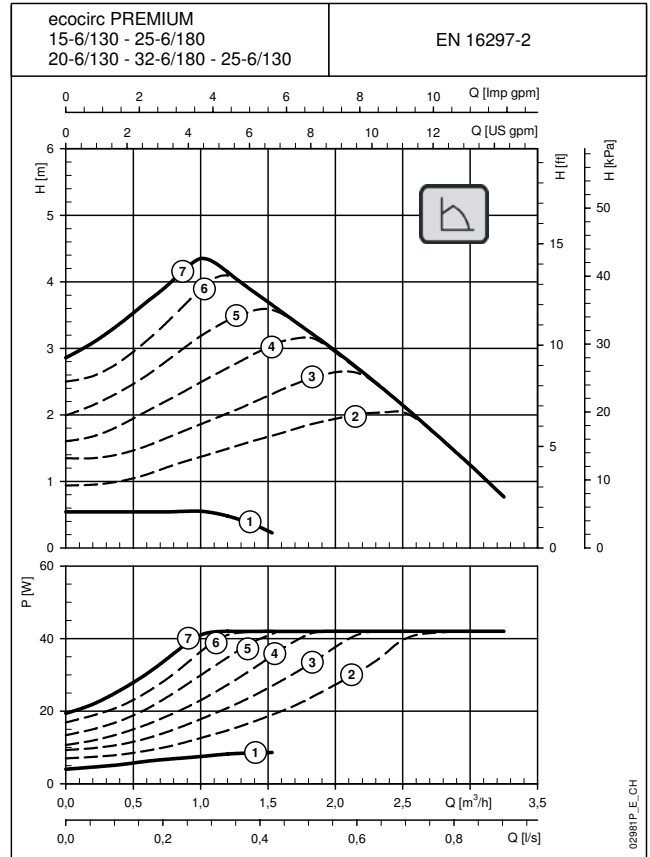
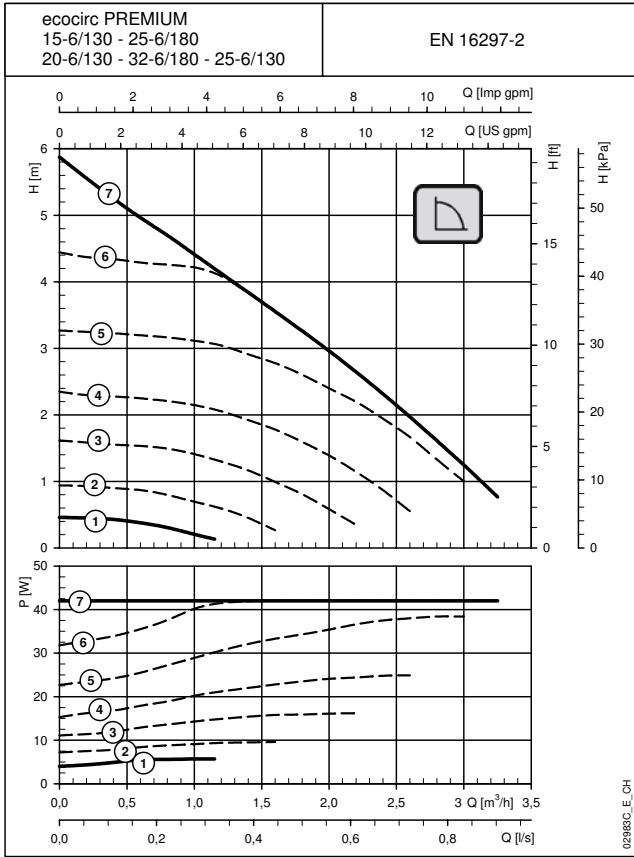

These performances are valid for liquids with density  $\rho = 1.0 \text{ Kg/dm}^3$  and kinematic viscosity  $\nu = 1 \text{ mm}^2/\text{sec}$ .  
Pump operates steplessly. Lines correspond to knob settings and are for reference only.

**ecocirc® PREMIUM SERIES  
DIMENSIONS AND WEIGHTS**

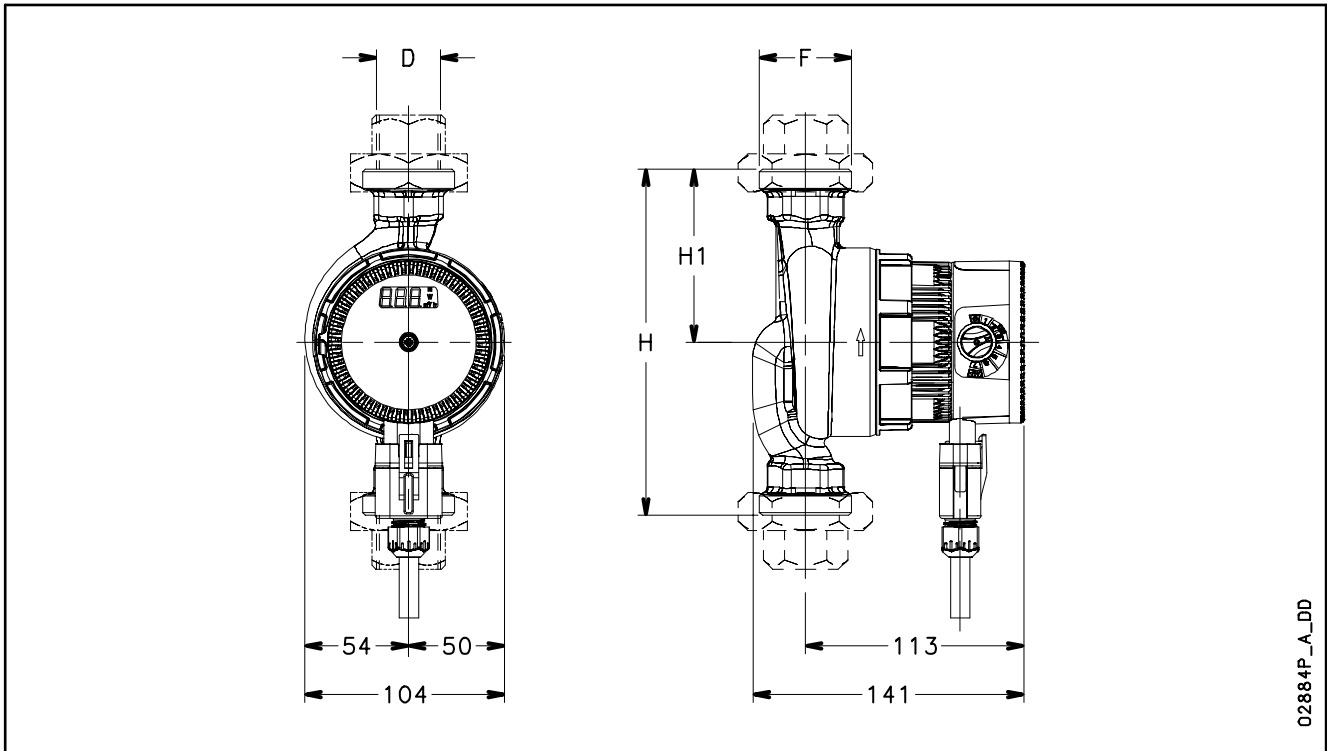

02884P\_A\_DD

**ecocirc PREMIUM...4/ TABLE**

PUMP TYPE ecocirc PREMIUM	DIMENSIONS (mm)		D	F	DN	WEIGHT kg
	H	H1				
15-4/130	130	65	Rp 1/2"	G 1"	15	1,9
20-4/130	130	65	Rp 3/4"	G 1 1/4"	20	2,0
25-4/130	130	65	Rp 1"	G 1 1/2"	25	2,1
25-4/180	180	90	Rp 1"	G 1 1/2"	25	2,4
32-4/180	180	90	Rp 1 1/4"	G 2"	32	2,4

ecocircP4-2p50-en\_a\_td

**ecocirc PREMIUM...6/ TABLE**

PUMP TYPE ecocirc PREMIUM	DIMENSIONS (mm)		D	F	DN	WEIGHT kg
	H	H1				
15-6/130	130	65	Rp 1/2"	G 1"	15	1,9
20-6/130	130	65	Rp 3/4"	G 1 1/4"	20	2,0
25-6/130	130	65	Rp 1"	G 1 1/2"	25	2,1
25-6/180	180	90	Rp 1"	G 1 1/2"	25	2,4
32-6/180	180	90	Rp 1 1/4"	G 2"	32	2,4

ecocircP6-2p50-en\_a\_td

# DOCUMENTATION

## FURTHER PRODUCT SELECTION AND DOCUMENTATION

### Xylect™

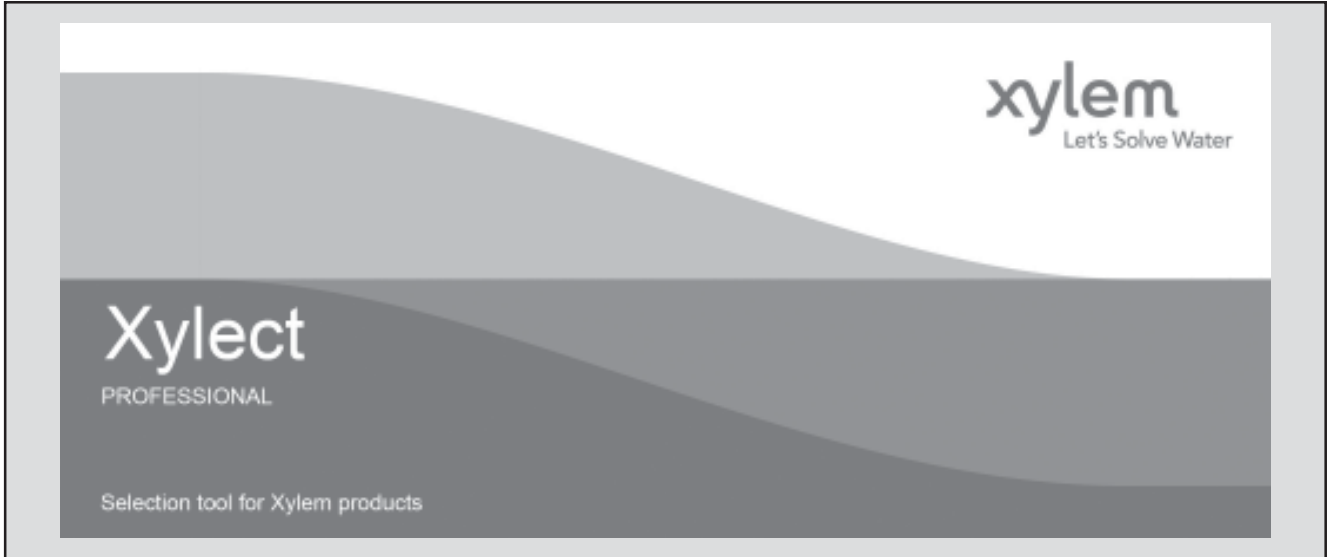

Xylect™ is pump solution selection software with an extensive online database of product information across the entire Lowara, and Vogel range of pumps and related products, with multiple search options and helpful project management facilities. The system holds up-to-date product information on thousands of products and accessories.

The possibility to search by applications and the detailed information output given makes it easy to make the optimal selection without having detailed knowledge about the Lowara and Vogel products.

The search can be made by:

- Application
- Product type
- Duty point

Xylect™ gives a detailed output:

- List with search results
- Performance curves (flow, head, power, efficiency, NPSH)
- Motor data
- Dimensional drawings
- Options
- Data sheet printouts
- Document downloads incl dxf files

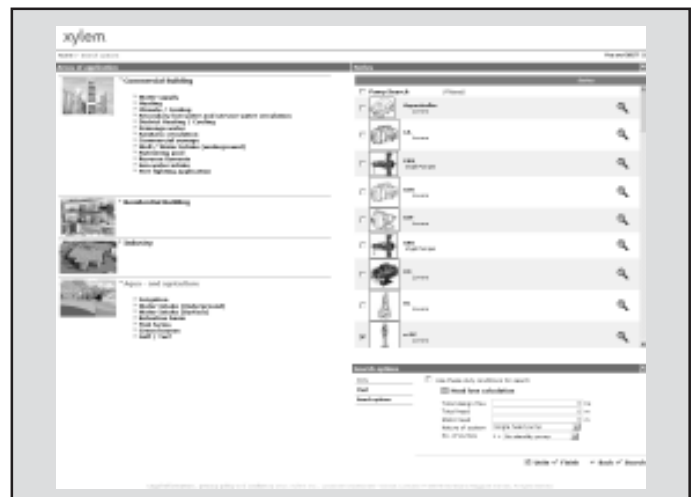

*The search by application guides users not familiar with the product range to the right choice.*

**FURTHER PRODUCT SELECTION AND DOCUMENTATION**

**Xylect™**

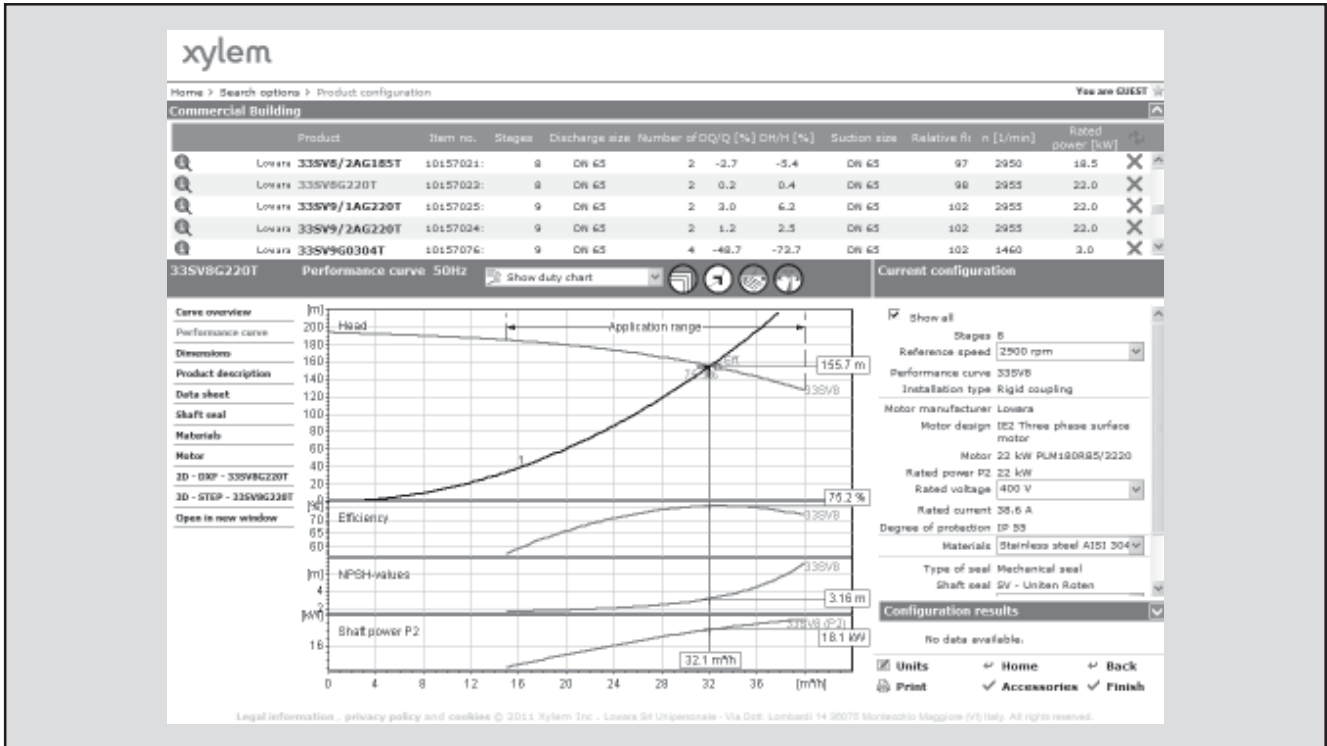

The detailed output makes it easy to select the optimal pump from the given alternatives.

The best way to work with Xylect™ is to create a personal account. This makes it possible to:

- Set own standard units
- Create and save projects
- Share projects with other Xylect™ users

Every user have a My Xylect space, where all projects are saved.

For more information about Xylect™ please contact our sales network or visit [www.xylect.com](http://www.xylect.com).

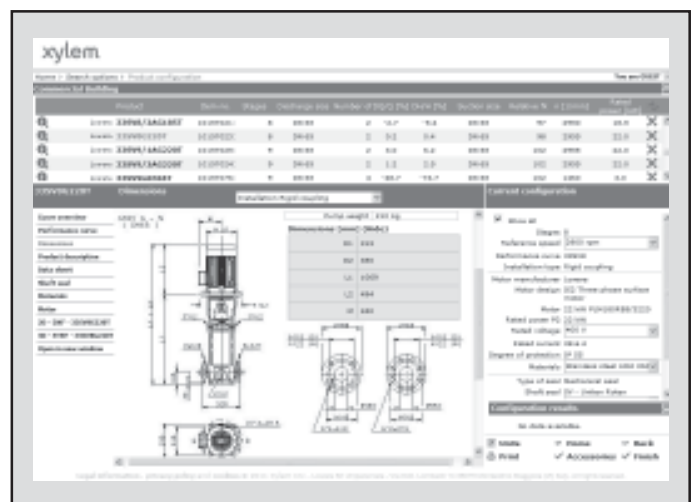

Dimensional drawings appear on the screen and can be downloaded in dxf format.

---

---

---

---

---

---

---

---

---

---

---

---

---

---

---

---

---

---

---

---

---

---

---

---

---

---

---

---



# Xylem |'zīləm|

- 1) The tissue in plants that brings water upward from the roots;
- 2) a leading global water technology company.

We're approximately 12,900 people unified in a common purpose: creating innovative solutions to meet our world's water needs. Developing new technologies that will improve the way water is used, conserved, and re-used in the future is central to our work. We move, treat, analyze, and return water to the environment, and we help people use water efficiently, in their homes, buildings, factories and farms. In more than 150 countries, we have strong, long-standing relationships with customers who know us for our powerful combination of leading product brands and applications expertise, backed by a legacy of innovation.

**For more information on how Xylem can help you, go to [xylem.com](http://xylem.com).**



Legal head office  
Xylem Water Solutions Italia Srl

Via Gioacchino Rossini 1/A  
20020 - Lainate (MI) - Italy  
Tel. (+39) 02 90358.1  
Fax (+39) 02 9019990  
[www.xylemwatersolutions.com](http://www.xylemwatersolutions.com)

For information and technical support  
Xylem Service Italia Srl

Via Dottor Vittorio Lombardi 14  
36075 - Montecchio Maggiore (VI) - Italy  
Tel. (+39) 0444 707111  
Fax (+39) 0444 491043  
[www.lowara.com](http://www.lowara.com)

Xylem Water Solutions Italia Srl reserves the right to make modification without prior notice.  
Lowara, Xylem are trademarks of Xylem Inc. or one of its subsidiaries  
© 2013 Xylem, Inc.