



Designation

NCE P 25 - 60 / 180

Series _____

Version _____

DN ports in mm _____

Max. head in dm _____

connection size mm _____

Construction

Energy saving variable speed circulating pump driven by a permanent magnet synchronous motor (pm) controlled by on board inverter.

Applications

Small domestic heating systems.
Floor heating systems.
Air conditioning systems.

Operating conditions

- Liquid temperature from +5 °C to +95 °C
- Ambient temperature from 0 °C to +40 °C
- Maximum permissible working pressure: 10 bar
- Storage: -20°C/+70°C max. relative humidity 95% at 40 °C
- Certifications: in conformity with CE requirements
- Sound pressure ≤ 38 dB (A).
- Minimum suction pressure: - 0,05 bar at 75 °C
- 0,28 bar a 90 °C.
- Maximum glycol quantity: 20%.
- EMC according to: EN 55014-1, EN 55014-2
EN 61000-3-2, EN 61000-3-2.
- Connections: threaded ports ISO 228: G 1, G 1 1/4, G 1 1/2, G 2.
- The benchmark for most efficient circulators is EEI ≤ 0,20.

Motor

- Synchronous motor with permanent magnet.
- Motor: variable speed
 - Standard voltage: single-phase 230 V (-10%;+6%)
 - Frequency: 50 Hz
 - Protection: IP 44
 - Insulation class: F
 - Overload protection (integrated).
 - Cable: phases and neutral.
 - Constructed in accordance with: EN 60335-1, EN 60335-2-51.

Special features on request

The NCE PR version is equipped with an additional module that allows to control the pump with an analog signal 0-10V. Brass or cast iron unions.

Features

Easy adjustment

The adjustment is simple and intuitive thanks to the LED indicator.

Easy use

3 proportional curves and 3 fixed speed curves are available and selectable by the button.

Operating modes

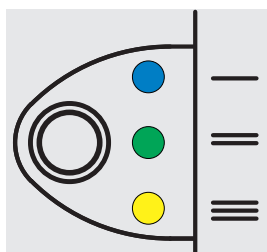

Operating functions - control buttons.

NCE P circulator could work:
 - with proportional pressure curves
 - with fixed speed curves



PROPORTIONAL CURVE PROGRAMMING $\Delta p-v$

- (P1 BLUE LED blinking light)
- (P2 GREEN LED blinking light)
- (P3 YELLOW LED blinking light)

Push repeatedly the button to select the proportional curve.
 The color changes depending on the selected curve.
 This operating mode guarantees the maximum energy efficiency.



FIXED SPEED CURVE PROGRAMMING

- (I BLUE LED light)
- (II GREEN LED light)
- (III YELLOW LED light)

If you push the button for 5 seconds the pump adopt the fixed speed curve. The color changes depending on the selected curve. (to replace standard 3-speed circulators).

Coverage chart

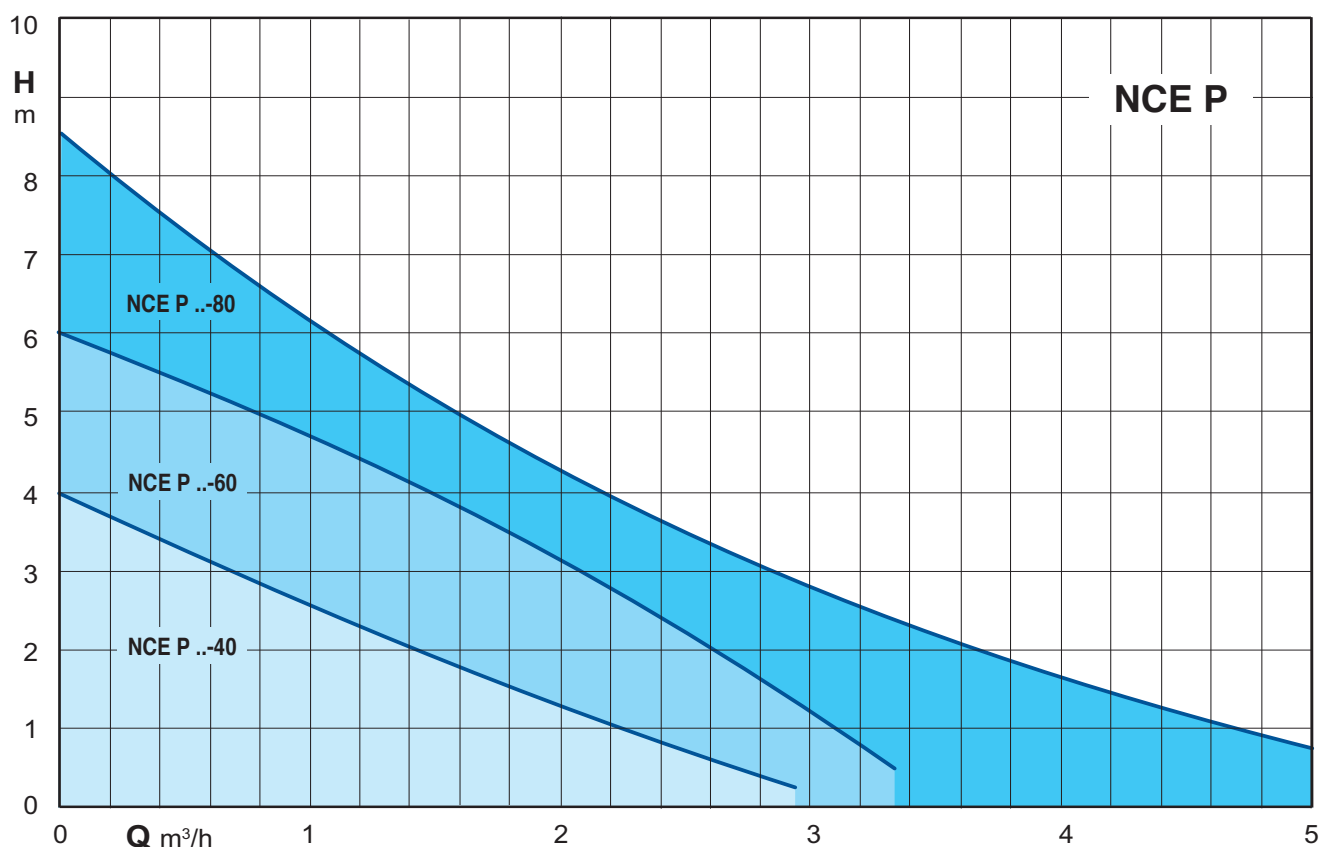

Characteristic curves

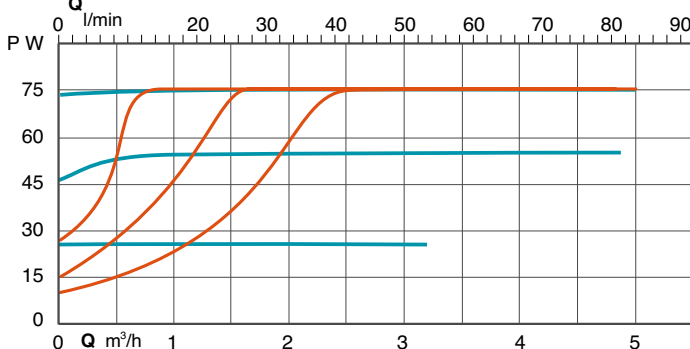
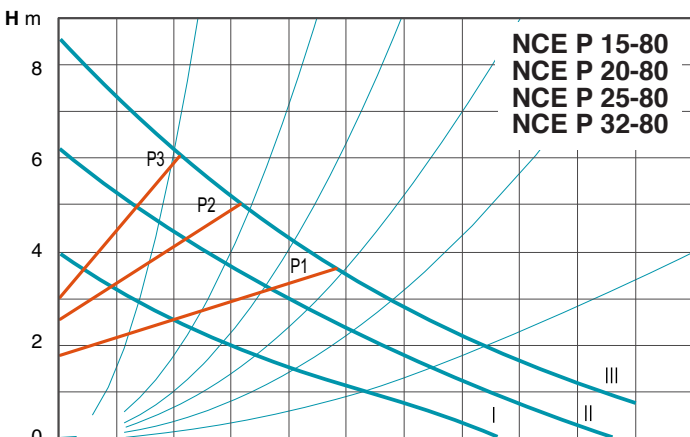
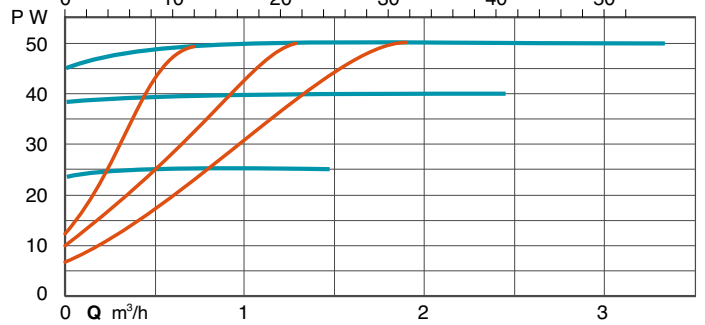
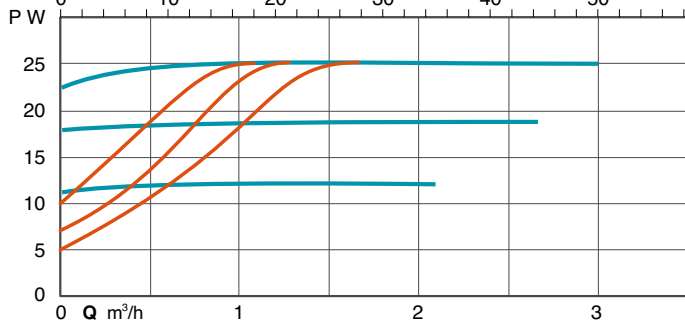
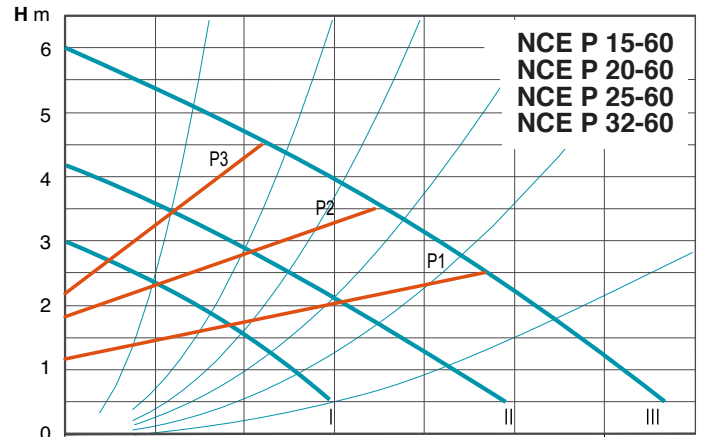
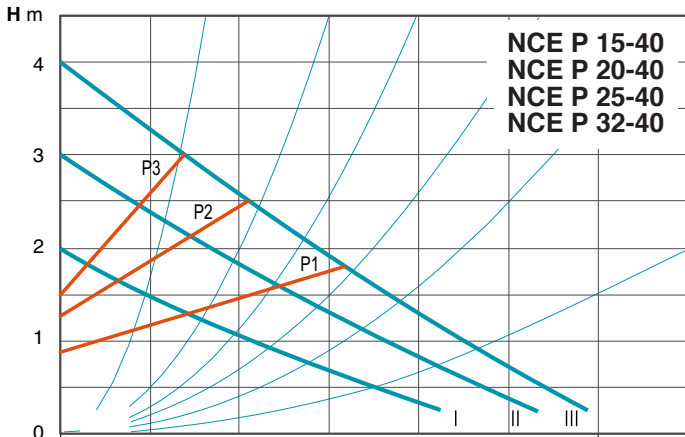

Materials

Component	Pos.	Material
Pump casing	1	Cast iron GJL 200 EN 1561
Impeller	2	Composite
Shaft	3	Ceramic
Bearings	4	Carbon
Thrust bearing	5	Ceramic
Rotor	6	Stainless steel jacket
Winding	7	Copper wire
Electronic card	8	-
Gasket	9	EPDM

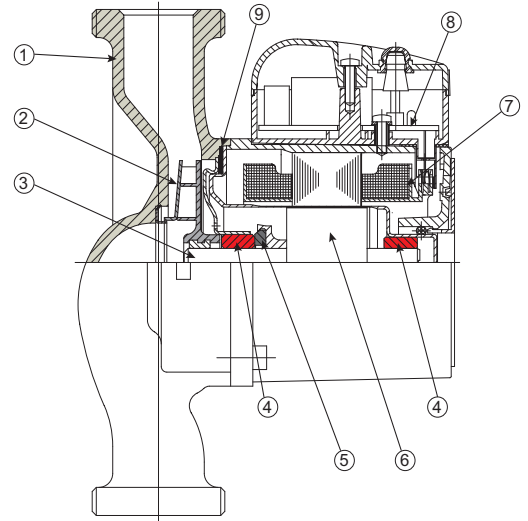

Examples of installations

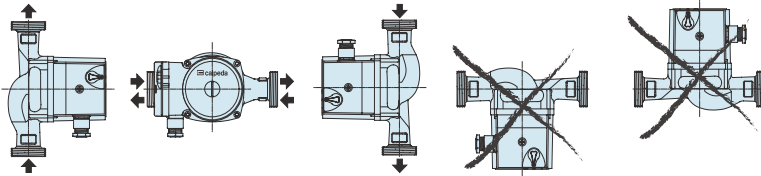

Dimensions and weights

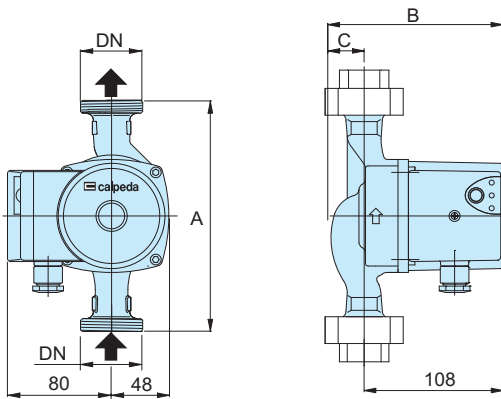

TYPE	DN	H m	Q m ³ /h	1~ 230 V		P1 W max	mm A	kg
				A min	A max			
NCE P 15-40/130	G 1	4	2,6	0,05	0,2	25	130	1,9
NCE P 20-40/130	G 1 1/4							2,1
NCE P 25-40/130	G 1 1/2							2,1
NCE P 20-40/180	G 1 1/4	4	2,6	0,05	0,2	25	180	2,2
NCE P 25-40/180	G 1 1/2							2,3
NCE P 32-40/180	G 2							2,7
NCE P 15-60/130	G 1	6	3,7	0,05	0,4	50	130	1,9
NCE P 20-60/130	G 1 1/4							2,1
NCE P 25-60/130	G 1 1/2							2,1
NCE P 20-60/180	G 1 1/4	6	3,7	0,05	0,4	50	180	2,2
NCE P 25-60/180	G 1 1/2							2,3
NCE P 32-60/180	G 2							2,7
NCE P 15-80/130	G 1	8	4,5	0,05	0,6	75	130	1,9
NCE P 20-80/130	G 1 1/4							2,1
NCE P 25-80/130	G 1 1/2							2,1
NCE P 20-80/180	G 1 1/4	8	4,5	0,05	0,6	75	180	2,3
NCE P 25-80/180	G 1 1/2							2,3
NCE P 32-80/180	G 2							2,7

Unions (on request)

TYPE	DN	DN1
KIT G 1 - G 1/2 (NCE . 15..)	G 1	G 1/2
KIT G 1 1/4 - G 3/4 (NCE . 20..)	G 1 1/4	G 3/4
KIT G 1 1/2 - G 1 (NCE . 25..)	G 1 1/2	G 1
KIT G 2 - G 1 1/4 (NCE . 32..)	G 2	G 1 1/4