



description générale

24.01.2025

version FANselect V 1.01 (250124), AMCA V 1.03 September, 2021-
RLT V 1.00 Dezember, 2021 / 1.25.01.24 | 1165 | (utilisateur paviot)

1



FN080-VDQ.7Q.A5P7 | 171318 | Portfolio Europe | FE2owlet AC

Technical Description FE2owlet

Range FN

Standard design with AC-motor

- Profiled, sickle shaped blades designed with bionical know how
- Sizes 310 ... 800 mm (in 9 standard sizes)
- Optimized for full bell mouth
- 100% speed controllable
- ZIEHL-ABEGG FE2owlet fans can be used from -40°C* up to 70°C.

Mains voltage:

- 3~ zweitourig 400 V ±10% D/Y
- 3~ zweitourig 400/460 V ±10% D/Y

Frequenz:

- 50 Hz
- 60 Hz

Thermal class:

- THCL 155

Protection:

- IP54

Motor protection:

- Thermostat relay (TB)

Material of impeller:

- Aluminium die-cast

Painting:

- Fan in color RAL 9005 deep black
- Wall ring plate and suspension in color RAL 9005 deep black

On request:

- Different paintings
- Fan designs

***Continuous operation with occasional starts (S1) according to DIN EN 60034-1: 2011-02. Occasional starting between -35 ° C and -25 ° C is permissible. Permanent operation below -25 ° C only possible with special bearings for refrigeration applications on request.**



données ventilateur

24.01.2025

version FANselect V 1.01 (250124), AMCA V 1.03 September, 2021
RLT V 1.00 Dezember, 2021 / 1.25.01.24 | 1165 | (utilisateur paviot)



type	FN080-VDQ.7Q.A5P7
n°article	171318 Portfolio Europe

caractéristiques

moteur		AC
tension principale	-	3~ 400V 50Hz D
intensité nominale (I _N)	A	6.80
température ambiante (t _r)	°C	70
rendement η _{statA}	%	40,4
Rendement N _{actual} N _{target}		43,2 40
classe ErP		2015
grille influence		pressure side not measured

données ventilateur

frequence (f _{BP}) (f _{max})	Hz	50 50
dimensions (LxIxh)	mm	970 x 970 x 341
poids (m _{pr})	kg	65.6

PF.PF_61; Ano:171318; STol:+-10 %



courbe debit/pression / Acoustic

24.01.2025

version FANselect V 1.01 (250124), AMCA V 1.03 September, 2021
 RLT V 1.00 Dezember, 2021 / 1.25.01.24 | 1165 | (utilisateur paviot)

1 FN080-VDQ.7Q.A5P7

Measured in full nozzle without guard grille in air flow direction V in installation type A according to ISO5801

171318 | Portfolio Europe

densité de mesure 1.17 [kg/m³]

Performance aéraulique p_{sF}

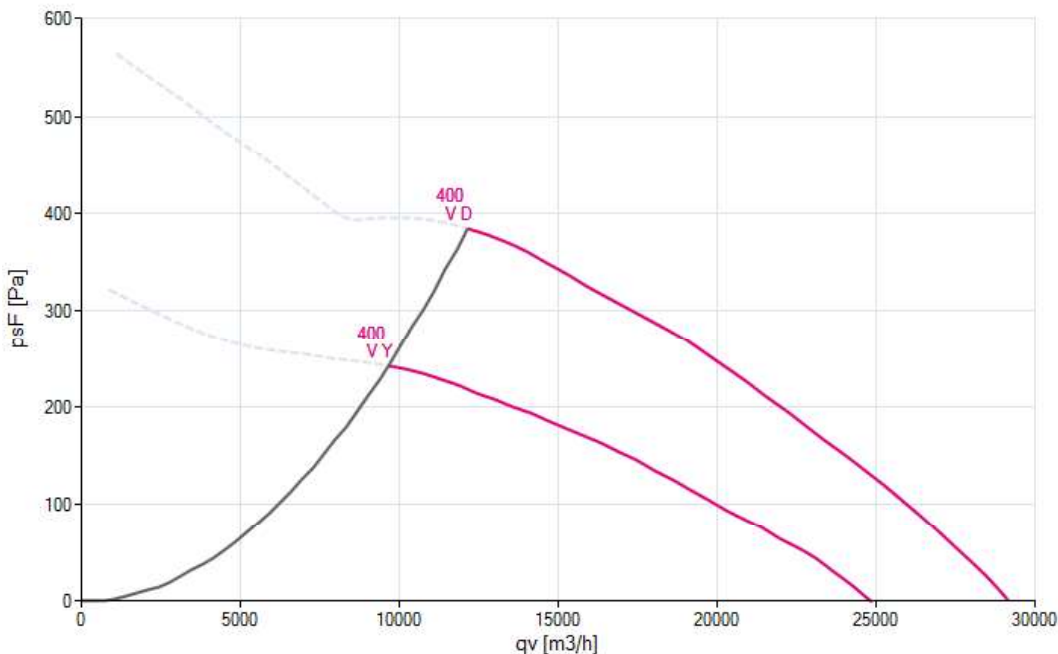

niveau de puissance acoustique côté aspiration-pondérées A (Niveau de puissance acoustique côté refoulement-pondérées A (L_{w(A),6}))

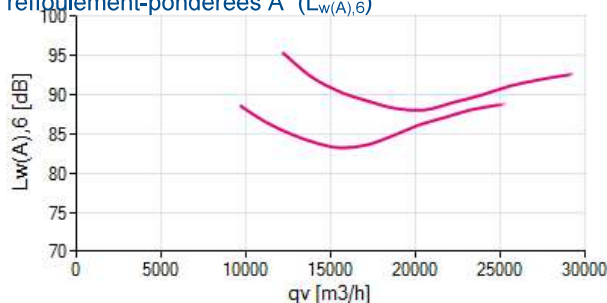
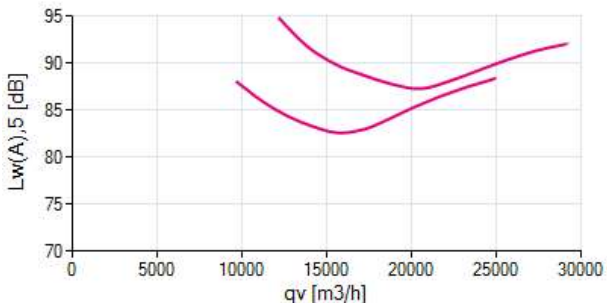

1 FN080-VDQ.7Q.A5P7

f [Hz]	sum	63	125	250	500	1000	2000	4000	8000
L _{w(A),5}	-	-	-	-	-	-	-	-	-
L _{w,5}	-	-	-	-	-	-	-	-	-

f [Hz]	sum	63	125	250	500	1000	2000	4000	8000
L _{w(A),6}	-	-	-	-	-	-	-	-	-
L _{w,6}	-	-	-	-	-	-	-	-	-



rendement / puissance

24.01.2025

version FANselect V 1.01 (250124), AMCA V 1.03 September, 2021
 RLT V 1.00 Dezember, 2021 / 1.25.01.24 | 1165 | (utilisateur paviot)

1

FN080-VDQ.7Q.A5P7

Measured in full nozzle without guard grille in air flow direction V in installation type A according to ISO5801

171318 | Portfolio Europe

densité de mesure 1.17 [kg/m³]

rendement η_F

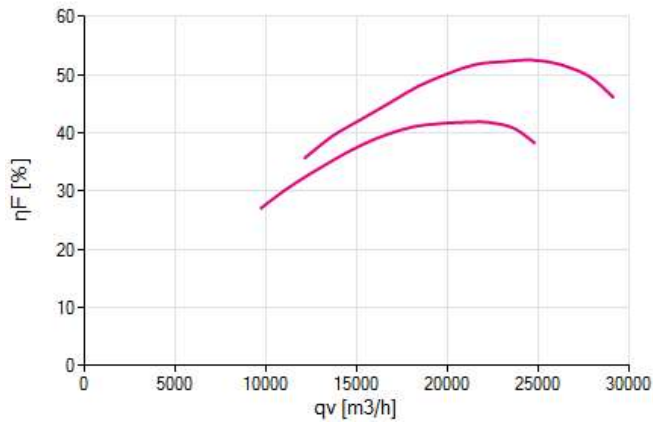

rendement η_{sF}

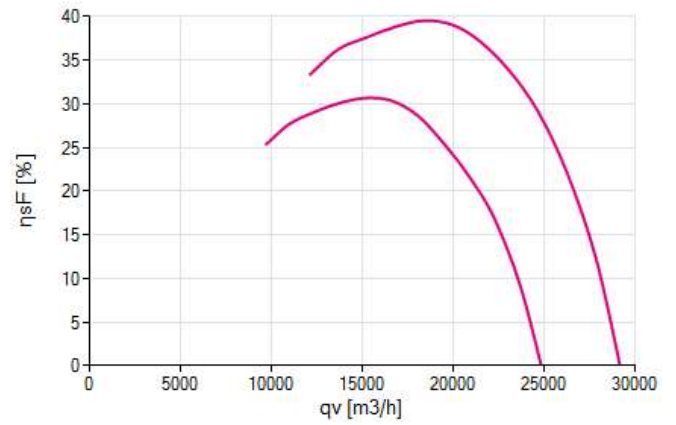

puissance P_1

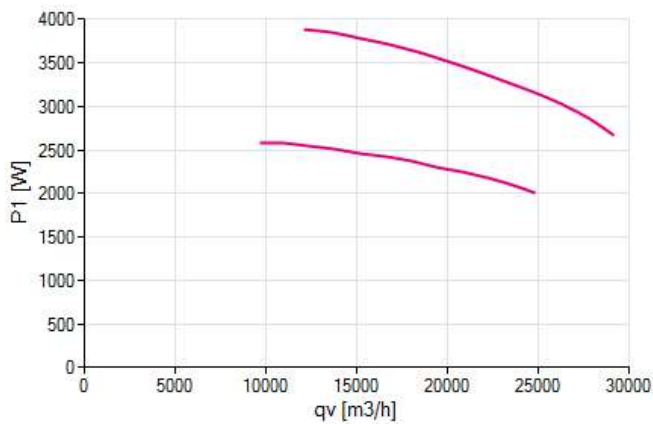

valeur nominale

version FANselect V 1.01 (250124), AMCA V 1.03 September, 2021
RLT V 1.00 Dezember, 2021 / 1.25.01.24 | 1165 | (utilisateur pavlot)

24.01.2025

1



FN080-VDQ.7Q.A5P7
171318

3~ 400V +10/-10 D/Y 50Hz P1 3.90/2.60kW
6.80/4.20A DI=5% 1310/1050/MIN COSY 0.83 70°C
IP54 THCL155

plan

version FANselect V 1.01 (250124), AMCA V 1.03 September, 2021
RLT V 1.00 Dezember, 2021 / 1.25.01.24 | 1165 | (utilisateur pavlot)

24.01.2025

1



FN080-VDQ.7Q.A5P7
171318



schéma de bobinage

version FANselect V 1.01 (250124), AMCA V 1.03 September, 2021
RLT V 1.00 Dezember, 2021 / 1.25.01.24 | 1165 | (utilisateur pavlot)

24.01.2025

1

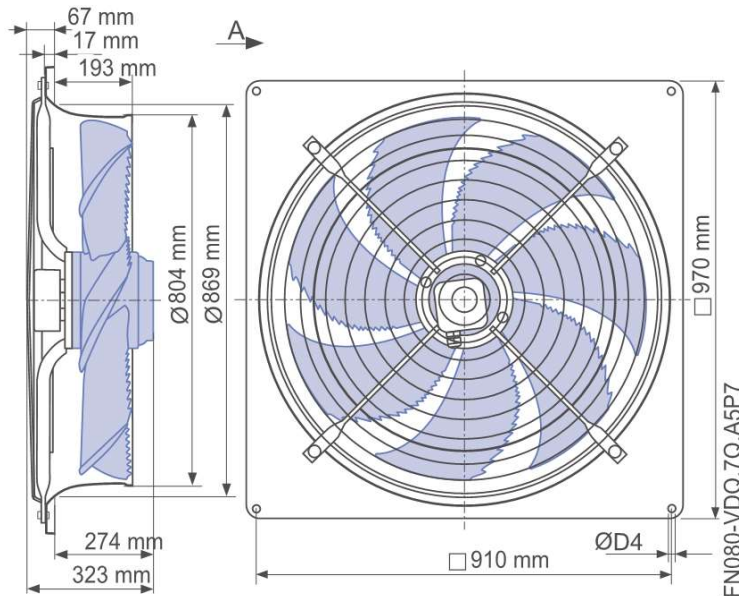

FN080-VDQ.7Q.A5P7
171318

1-Motor mit Kondensator und Thermostatschalter.
1-Motor with capacitor and thermostatic switch.
Moteur monophasé avec condensateur et interrupteur thermostatique.

UZ	blau oder grau	blue or grey	bleu ou gris
Z2	schwarz	black	noir
TB	braun	brown	brun

not available



Anschlussschaltbild im Anschlusskasten aufbewahren.
Keep wiring diagram in terminal box.
Conserver le schéma de raccordement dans la boîte à bornes.



type	FN080-VDQ.7Q.A5P7
n°article	171318