

PLAGES D'UTILISATION

Débits jusqu'à :	1800 m³/h
Hauteurs mano. jusqu'à :	140 mCE
Pression de service :	Jusqu'à 16 bar*
Plage de température :	-20 à +120°C

*selon modèles

NOLH

POMPES CENTRIFUGES MONOCELLULAIRES NORMALISEES EN 733 (NFE 44111), ISO 5199 Industrie – Agriculture – Chauffage

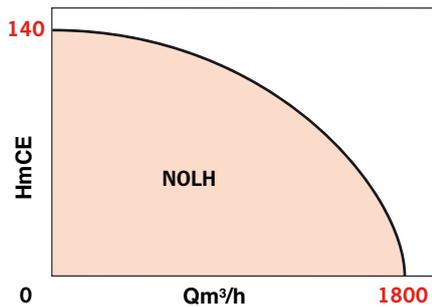

AVANTAGES

- Performances hydrauliques et cotes fonctionnelles de raccordement conformes à la norme EN 733 en 50 tailles + 19 modèles "extension".
- Arbre et paliers renforcés pour répondre à la norme ISO 5199.
- La gamme standard est équipée de châssis fonte pour assurer une meilleure rigidité de l'ensemble.
- Possibilité de construction en fonte lamellaire (version ML) ou en inox 316 (version MX), en fonction de l'application.
- Maintenance aisée grâce au système "process" permettant le démontage du mobile sans débrider le corps de pompe ni déplacer le moteur (avec l'option spacer).
- Quench et flushing optionnels sur demande.

APPLICATIONS

Pompage de fluides clairs ou légèrement troubles sans particules solides dans les domaines d'applications suivants :

- Industrie générale, plastique, peinture, textile, papier, etc.
- Industrie alimentaires, pharmaceutique, etc.
- Industrie du bâtiment
- Relevage d'effluents
- Chauffage et climatisation.

• Version ATEX possible

Un large choix de matériaux permet de répondre à des besoins spécifiques en industrie.

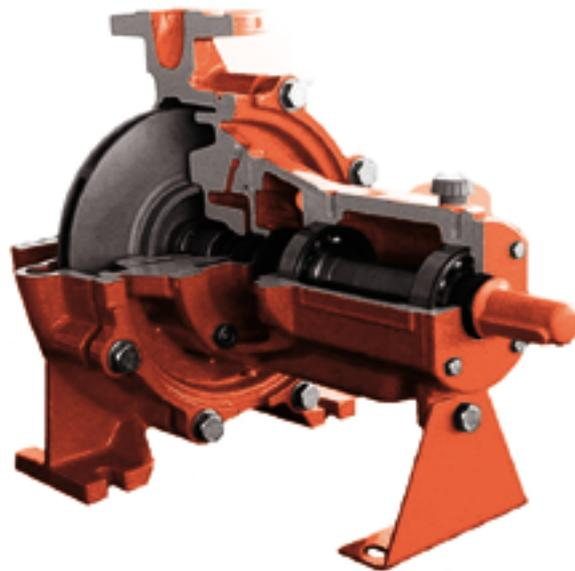

• NOLH version arbre nu

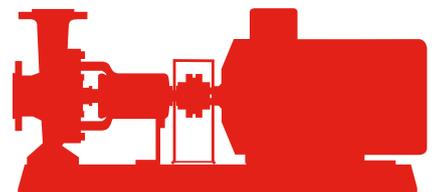
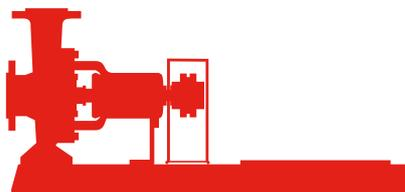
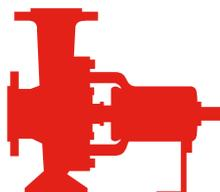

NOLH

CONCEPTION

• Partie hydraulique :

- Centrifuge monocellulaire, axe horizontal. Aspiration axiale, refoulement radial vers le haut.
- Pattes de fixation sous le corps.
- Palier monobloc, roulements renforcés de guidage de l'arbre lubrifiés par graisse ou par bain d'huile (selon l'option).
- tanchéité par garniture mécanique simple, nombreux matériaux possibles (20 types).
- Adaptation du diamètre de la roue pour obtenir un point de fonctionnement donné.
- Joint de corps en fibre pour la version fonte, Teflon PTFE pour la version inox 316

• Moteur

Normalisé selon I.E.C. et DIN/VDE 0530

Vitesse : 1450 – 2900 tr/min

Tension : 230 / 400 V

au delà de 4 kW : 400 / 690V

Fréquence : 50 Hz - 60 Hz*

Classe d'isolation : 155 (F)

Classe d'efficacité : EFF2

Protection : IP 55

Conformité CE : EN 809

* (Nous consulter)

• Socle :

Matériau : Acier (fonte sur demande)

DESCRIPTION

Paliers :

Paliers de 25, 35 et 45 : deux roulements à billes, graissés à vie (2Z), désignation B, ou lubrification par huile, désignation C. Paliers de 55 et 65 : Un roulement à double rangée oblique côté pompe, plus un roulement à billes côté entraînement, graissés à vie (S) ou lubrifiés par huile (T).

Lubrification par huile avec Huileur à Niveau Constant possible.

IDENTIFICATION

NOLH 050-200 MX

Type de pompe _____

Diamètre bride refoulement _____

Dimension nominale de la roue _____

Version et matériaux _____

(ML = Fonte lamellaire, MX = Inox)

Désignation	Matériaux				Construction		Repère
	Mat. N°	DIN	ISO EN	US Material		ML	
				ASTM Standard	AISI		
Volute	EN-JL 1040	GG-25	EN-GJL 250	A 278 Cl. 30		•	10.20
	1.4408	GX6CrNiMo18 10	GX5CrNiMo19-11-2	A 351 CF8M	316	•	
Fond de volute	EN-JL 1040	GG-25	EN-GJL 250	A 278 Cl. 30		•	16.10
	1.4408	GX6CrNiMo18 10	GX5CrNiMo19-11-2	A 351 CF8M	316	•	
Arbre	1.0503	C 45	C 45	A 576 Gr1045	1 045	•	21.00
	1.4401	X5CrNiMo17 12 2	X5CrNiMo17 12 2	A 167 Gr316	316	•	
Roue	EN-JL 1040	GG-25	EN-GJL 250	A 278 Cl. 30		•	
	2.1050	G-CuSn10		B 427 C91600		•	23.00
	1.4408	GX6CrNiMo18 10	GX5CrNiMo19-11-2	A 351 CF8M	316	•	
Corps de palier	EN-JL 1040	GG-25	EN-GJL 250	A 278 Cl. 30		•	33.00
	1.4021	X 20 Cr13	X 20 Cr13	A 276 Type 420	420	•	
Chemise d'arbre/presse-étoupe	1.4401	X5CrNiMo17 12 2	X5CrNiMo17 12 2	A 167 Gr316	316	•	52.40
						•	43.30
Garniture mécanique		Carbure / Carbure / Viton, Carbone / Carbure / PTFE...				•	

* Disponible uniquement sur les tailles 32-125 à 15040 et la taille 200250.

DESCRIPTION

Palier en fonction des tailles de pompe :

Palier de 25	32125	32160	32200	32250	40125	40160	40200	40250	50125	50160	50200	50250	65125	65160	65200	80160
Palier de 35	40315	50315	65250	65315	80200	80250	80315	100160	100200	100250	100315	125200	125250	150200	150250	
Palier de 45	80400	100400	125315	125400	150315	150400	200250									
Palier de 55	150500	200315	200400	200500	250300	250315										
Palier de 65	250400	250500	300400	300500												

Puissance moteur :

Les moteurs électriques standards équipant les pompes NOLH sont de type de construction IM B3.

Lors de la détermination de la puissance moteur, nous recommandons d'appliquer les marges de sécurité suivantes :

- Jusqu'à 4 kW : +25%
- de 4 à 7,5 kW : +20%
- au-delà de 7,5 kW : +15%

Les vitesses maximales suivantes doivent être respectées en fonction des tailles de pompes :

Modèle	Vmax. (min-1)	Modèle	Vmax. (min-1)	Modèle	Vmax. (min-1)	Modèle	Vmax. (min-1)
32125	3600	32250	3000	40315	1800	150500	1500
32160							
32200							
40125							
40160							
40200							
50125							
50160							
50200							
65125							
65160	1800	125250	1500	125315	1500	200315	
65200							
80160							
80200							
100160							
100200							
100250							
125200							
125400							
150200							
150250	1800	150315	1500	200250	1500	200400	
150400							
200250							
200315							
200400							
200500							
250300							
250315							
250400							
250500							

En fonction des matériaux choisis, certaines vitesses du tableau ci-contre sont limitées sur certains modèles de pompes :

- 1) Matière MX vitesse max. 3000 tr/min
- 2) Matière MX vitesse max. 1800 tr/min
- 3) Matière MX vitesse max. 3000 tr/min
- 4) Matière MX vitesse max. 1500 tr/min

PLAN COUPE DE PRINCIPE

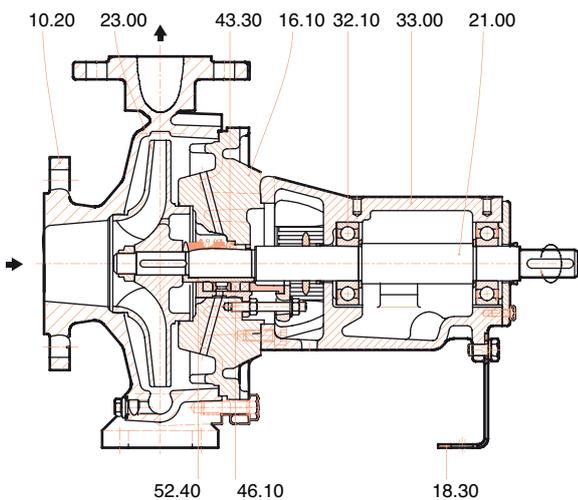

Palier taille 25, 35, 45

- 10.20 volute
- 16.10 fond de volute
- 18.30 pied support
- 21.00 arbre
- 23.00 roue
- 32.10 roulement
- 33.00 corps de palier

- 43.30 garniture mécanique
- 46.10 boîtier de presse-étoupe
- 52.40 chemise d'arbre (presse-étoupe)

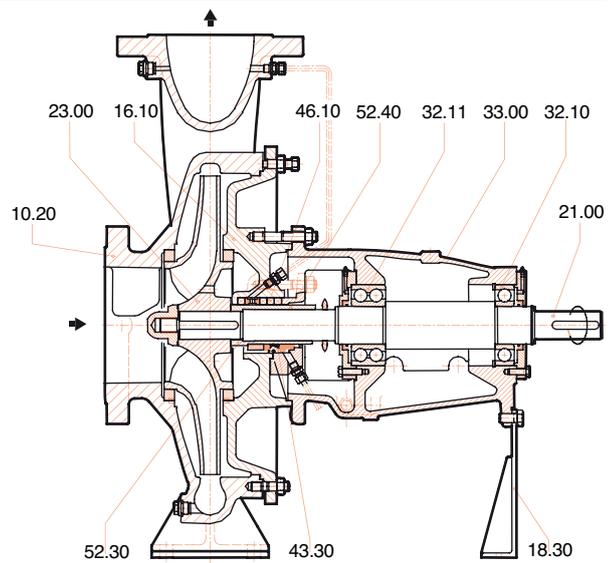

Palier taille 55, 65

- 10.20 volute
- 16.10 fond de volute
- 18.30 pied support
- 21.00 arbre
- 23.00 roue
- 32.10 roulement
- 32.11 roulement

- 33.00 corps de palier
- 43.30 garniture mécanique
- 46.10 boîtier de presse-étoupe
- 52.30 chemise d'arbre (garniture mécanique)
- 52.40 chemise d'arbre (presse-étoupe)

NOLH

SPECIFICATION

• SPECIFICATION DE CONCEPTION

Corps

Ouvert c t i t e n e m e n t p o u r p e r m e t t r e l e d e m o n t a g e p a r l a r r i e r e d e l e n s e m b l e m e c a n i q u e . P a t t e s d e f i x a t i o n s o u s l a v o l u t e .

Aspiration axiale, refoulement radial vers le haut.

Fond

Fix e n t r e l e c o r p s e t l e p a l i e r . P r e v u a v e c u n l o g e m e n t r e c e v a n t l e s y s t e m e d e t a n c h e m e n t d a r b r e , g a r n i t u r e m e c a n i q u e o u t r e s s e s .

(de nombreuses options possibles, Quench, Flushing, enveloppe de r e c h a u f f a g e , e t c)

Palier

Monobloc, largement dimensionn e p o u r r e p o n d r e a l a n o r m e I S O 5 1 9 9 e t s u p p o r t e p a r u n e b o u i l l e . R o u l e m e n t s a b i l l e s a g o r g e p r o f o n d e d e g u i d a g e d e l a r b r e , l u b r i f i e s p a r g r a i s s e . (P a l i e r a h u i l e o p t i o n n e l) U n d e f l e c t e u r c e n t r i f u g e a s s u r e l a p r o t e c t i o n c o n t r e t o u t e p e n e t r a t i o n d e l i q u i d e .

Arbre

Largement dimensionn e p o u r r e p o n d r e a l a n o r m e I S O 5 1 9 9 , i l a c c r o t l a d u r e e d e v i e d e l a g a r n i t u r e d e t a n c h e m e n t . C h e m i s e a v e c g a r n i t u r e a t r e s s e e t a v e c p a l i e r s t a i l l e 5 5 e t 6 5 .

Roue

Ferme haut rendement, radiale avec t a n c h e m e n t a r r i e r e e t t r o u s d e q u i l i b r a g e . A d a p t e (r o g n e) s u r d e m a n d e p o u r l o b t e n t i o n d u Q / H r e q u i s p a r l i n s t a l l a t i o n .

Étanchéité d'arbre

t a n c h e m e n t p a r g a r n i t u r e m e c a n i q u e s i m p l e , n o m b r e u x m a t e r i a u x p o s s i b l e s (2 0 t y p e s) . G a r n i t u r e m e c a n i q u e e g a l e m e n t d i s p o n i b l e a v e c r e s s o r t p r o t e g e (s u r d e m a n d e) .

Accouplement

Standard, semi-elastique avec ou sans p i c e d e s p a c e m e n t e n f o n c t i o n d e l a d e m a n d e .

OPTIONS

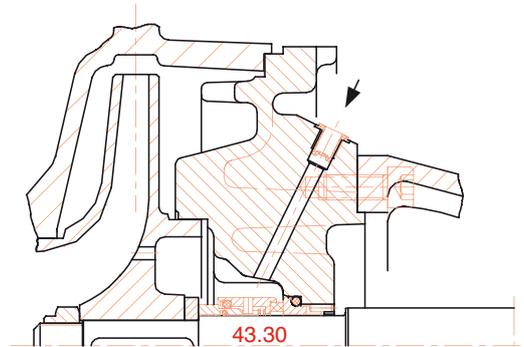

• EXTERNAL FLUSHING

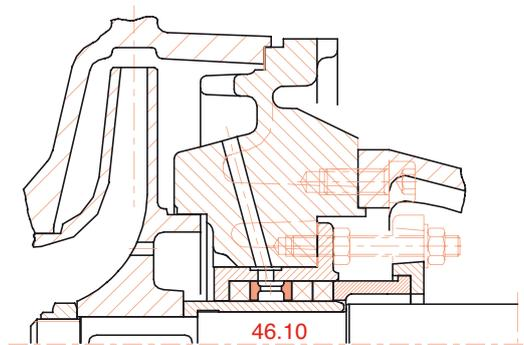

• GARNITURE A TRESSE

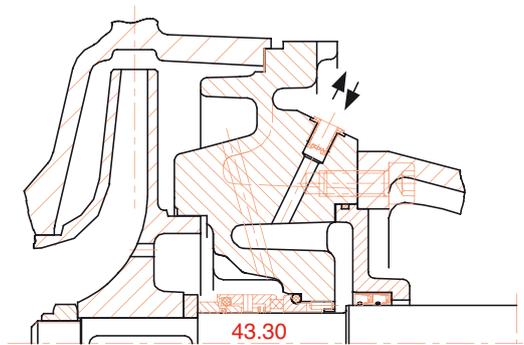

• QUENCH

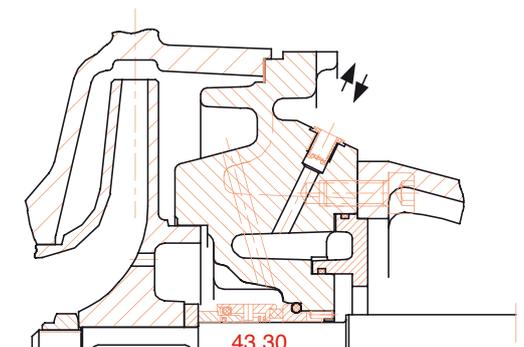

• RECHAUFFAGE

SPÉCIFICATIONS DE L'HYDRAULIQUE

Modèle	CARACTERISTIQUES DES BRIDES				PRESSION MAXIMALE ADMISSIBLE	
	Diamètre Nominal (mm)		Pression Nominale (bar)		Pompe fonte (ML)	Pompe Inox 316 (MX)
	Aspiration (DN1)	Refoulement (DN2)	Brides en fonte (ML)	Brides en Inox 316 (MX)		
NOLH 32125						
NOLH 32160						
NOLH 32200	50	32				
NOLH 32250						
NOLH 40125						
NOLH 40160						
NOLH 40200		40				
NOLH 40250						
NOLH 40315	65					
NOLH 50125						
NOLH 50160						
NOLH 50200		50			16	
NOLH 50250						
NOLH 50315						
NOLH 65125						
NOLH 65160						
NOLH 65200	80	65				
NOLH 65250						
NOLH 65315				16		
NOLH 80160						
NOLH 80200	100	80				
NOLH 80250						
NOLH 80315						
NOLH 80400						16
NOLH 100160						
NOLH 100200	125	100				
NOLH 100250						
NOLH 100315						
NOLH 100400						
NOLH 125200					10	
NOLH 125250	150	125				
NOLH 125315						
NOLH 125400						
NOLH 150200						
NOLH 150250						
NOLH 150315	200	150				
NOLH 150400						
NOLH 150500					14	
NOLH 200250			10	16		
NOLH 200315						
NOLH 200400	250	200				
NOLH 200500						
NOLH 250300					10	
NOLH 250315	300	250		16		
NOLH 250400						
NOLH 250500						
NOLH 300400	350	300				
NOLH 300500						

NOLH

GUIDE DE PRESELECTION HYDRAULIQUE

• 4 pôles

Mod le	Courbe	Dimensions	
		Avec spacer	Sans spacer
32-125 ^			
32-200A	Page 07	Page 31	Page 38
32-200B ^		Page 31	Page 38
40-160	Page 08	Page 32	Page 38
40-200 ^			Page 38
50-125	Page 09	Page 32	Page 39
50-160 ^		Page 32	Page 39
50-315	Page 10	Page 32	Page 39
65-125 ^		Page 32	Page 39
65-250	Page 11	Page 33	Page 40
65-315 ^		Page 33	Page 40
80-250	Page 12	Page 33	Page 40
80-315 ^		Page 33	Page 40
100-200	Page 13	Page 34	Page 41
100-250 ^		Page 34	Page 41
125-200	Page 14	Page 34	Page 41
125-250 ^		Page 34	Page 41
150-200	Page 15	Page 35	Page 41
150-250 ^		Page 35	Page 42
150-500	Page 16	Page 35	Page 42
200-250 ^		Page 35	Page 42
200-500	Page 17	Page 36	Page 43
250-300 ^		Page 36	Page 43
250-500	Page 18	Page 37	Page 44
300-400 ^		Page 37	Page 44
300-500	Page 19	Page 37	Page 44

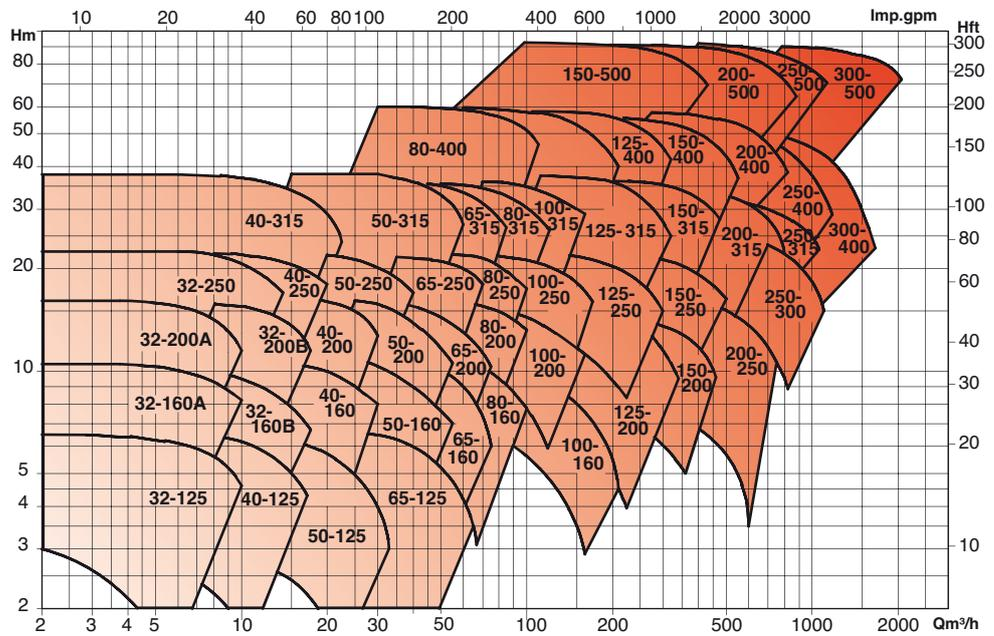

• 2 pôles

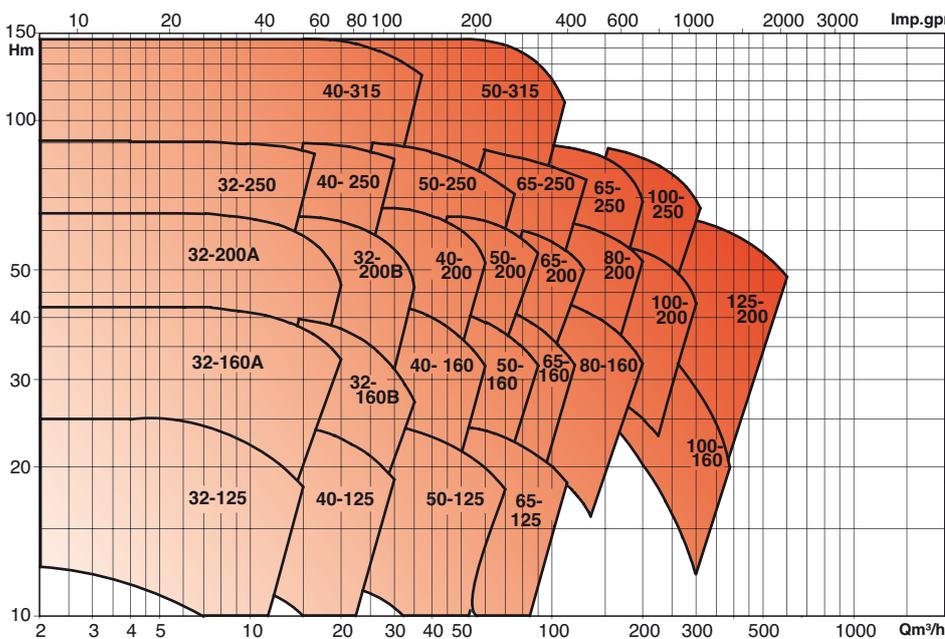

Mod le	Courbe	Dimensions	
		Avec spacer	Sans spacer
32-125 ^			
32-200A	Page 20	Page 45	Page 49
32-200B ^		Page 45	Page 49
40-160	Page 21	Page 46	Page 50
40-200 ^		Page 46	Page 50
50-125	Page 22	Page 46	Page 50
50-160 ^		Page 46	Page 50
50-315	Page 23	Page 47	Page 51
65-125 ^		Page 47	Page 51
65-250	Page 24	Page 48	Page 52
80-160 ^		Page 48	Page 52
100-160	Page 25	Page 48	Page 52
100-200 ^		Page 48	Page 52
125-200	Page 26	Page 48	Page 52

PERFORMANCES HYDRAULIQUES

1450 MIN⁻¹

Facteur Q min./Q nom. 0,3 Facteur Q max./Q nom. 1,2
 NOLH 32-125

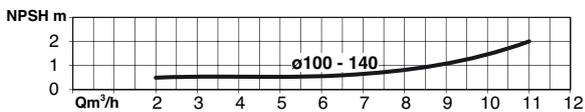
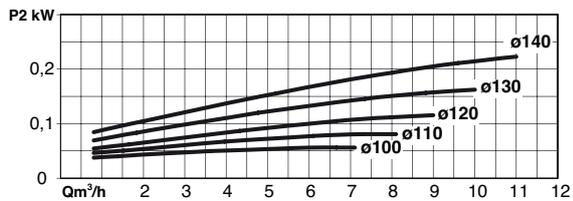
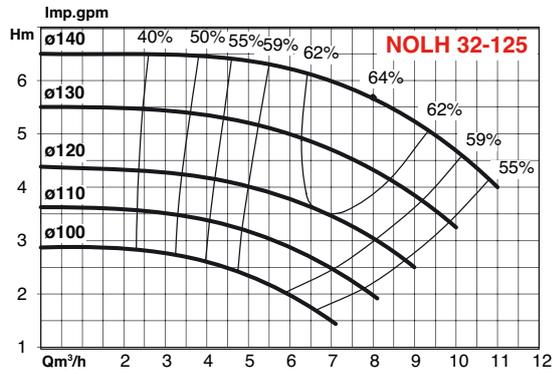

Facteur Q min./Q nom. 0,3 Facteur Q max./Q nom. 1,2
 NOLH 32-160A

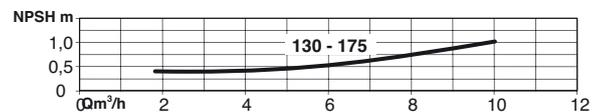
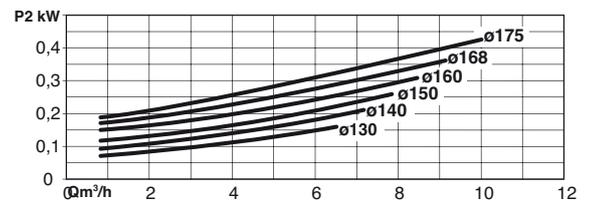
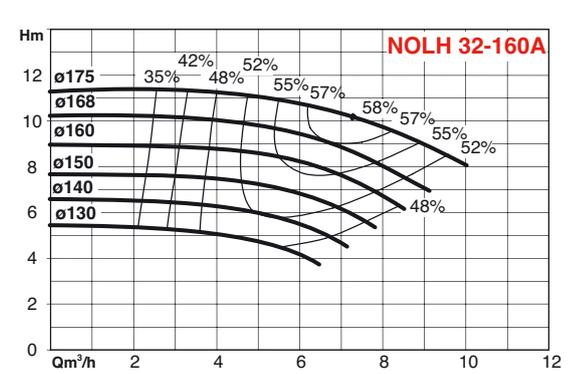

Facteur Q min./Q nom. 0,3 Facteur Q max./Q nom. 1,2
 NOLH 32-160B

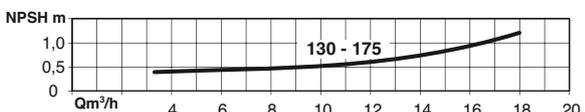
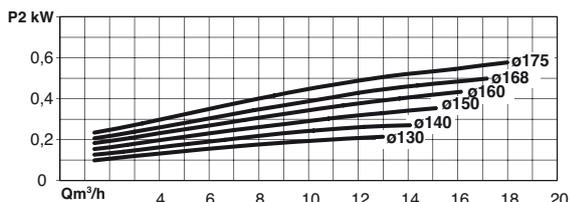
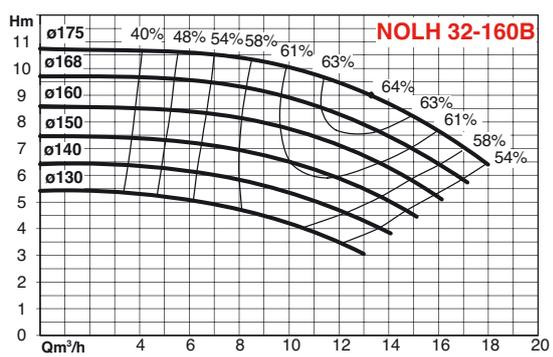

Facteur Q min./Q nom. 0,3 Facteur Q max./Q nom. 1,2
 NOLH 32-200A

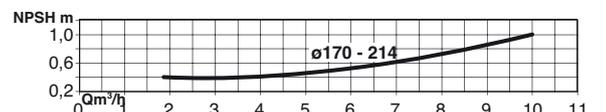
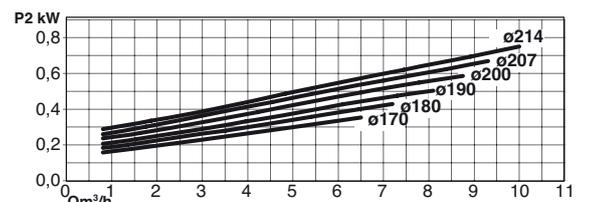
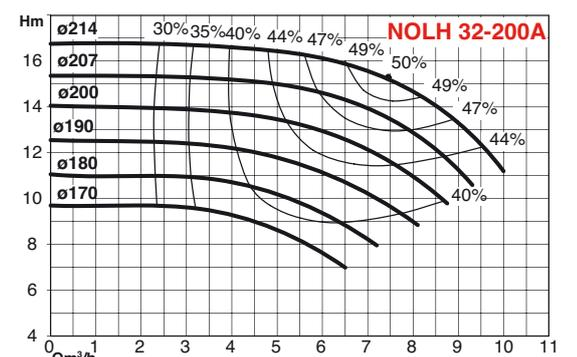

NOLH

PERFORMANCES HYDRAULIQUES 1450 MIN⁻¹

Facteur Q min./Q nom. Facteur Q max./Q nom.
 NOLH 32-200B 0,3 1,2

Facteur Q min./Q nom. Facteur Q max./Q nom.
 NOLH 32-250 0,3 1,1

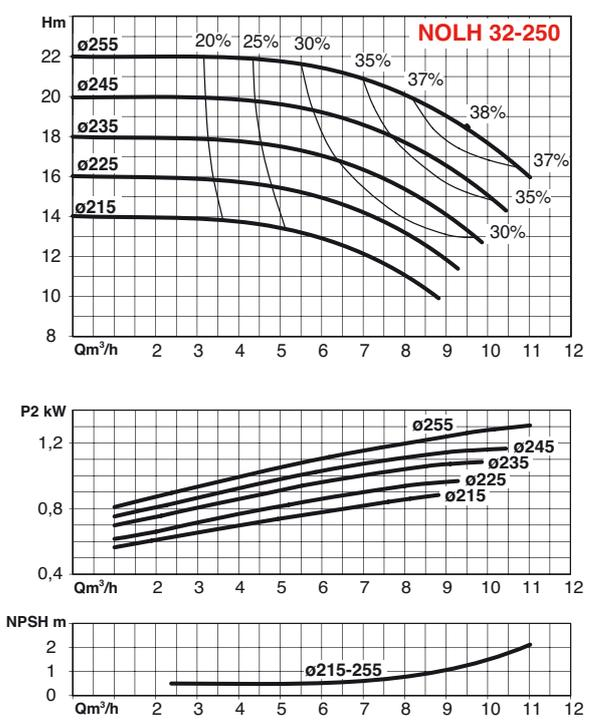
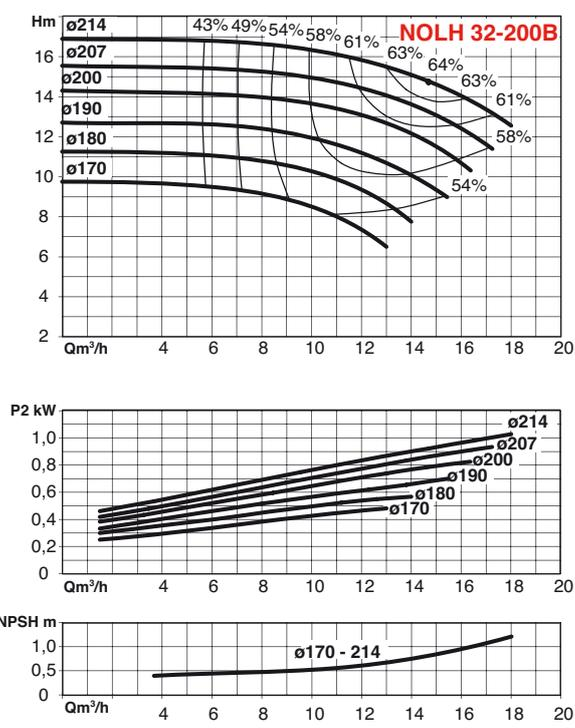

Facteur Q min./Q nom. Facteur Q max./Q nom.
 NOLH 40-125 0,3 1,2

Facteur Q min./Q nom. Facteur Q max./Q nom.
 NOLH 40-160 0,3 1,2

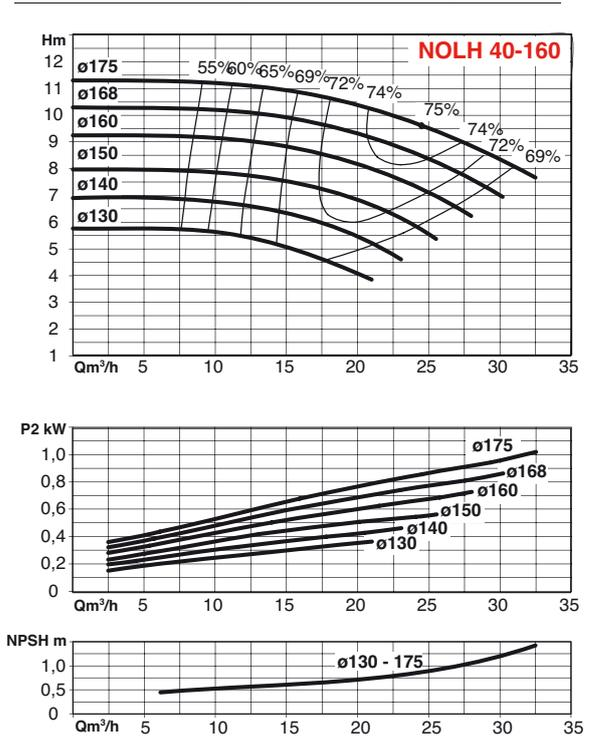
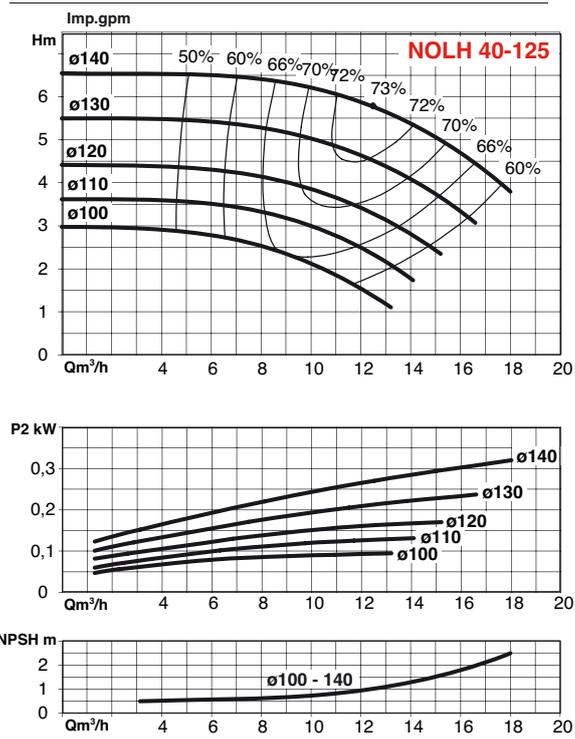

PERFORMANCES HYDRAULIQUES

1450 MIN⁻¹

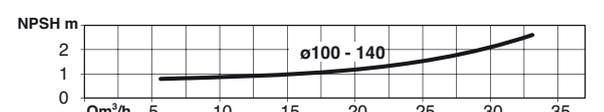
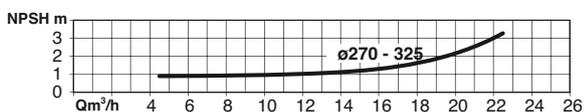
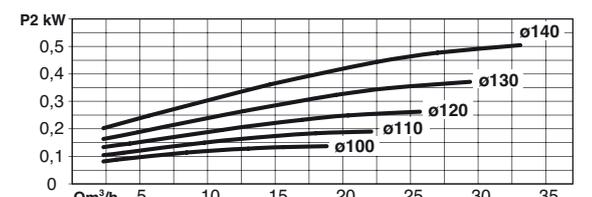
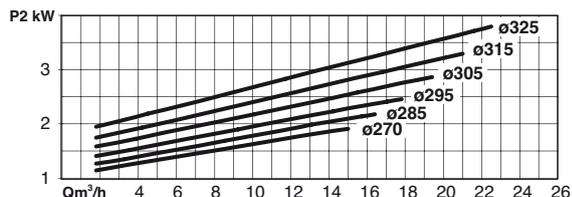
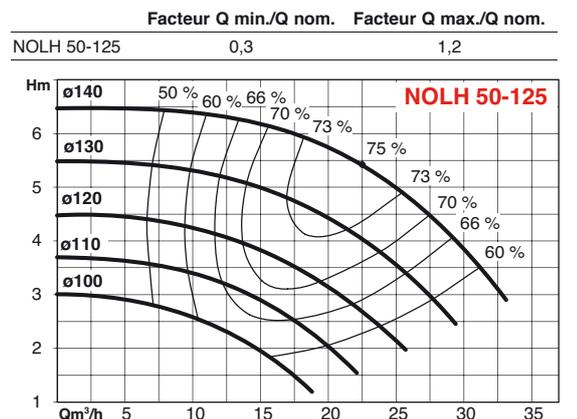
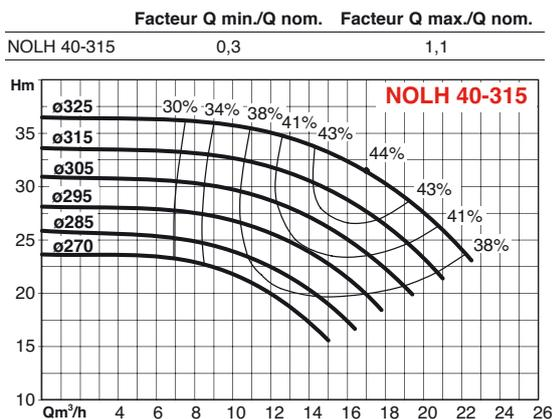
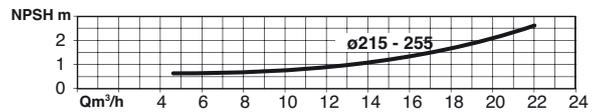
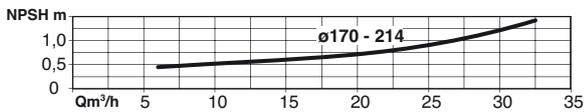
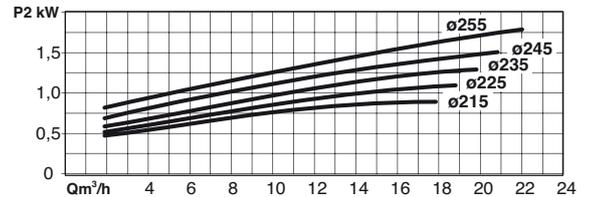
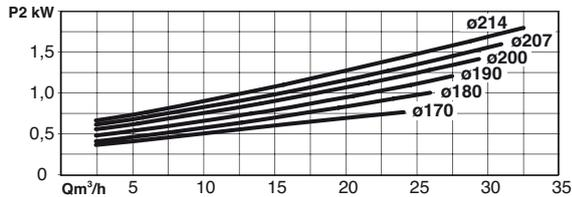
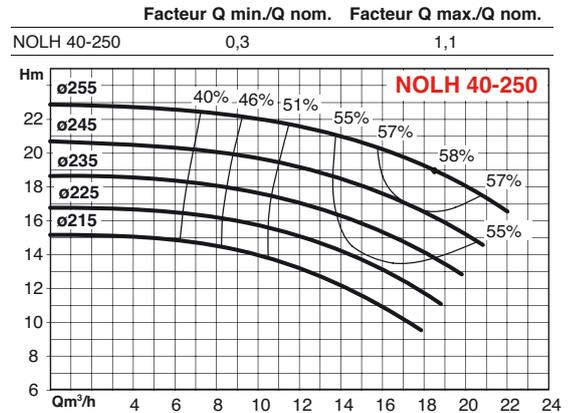
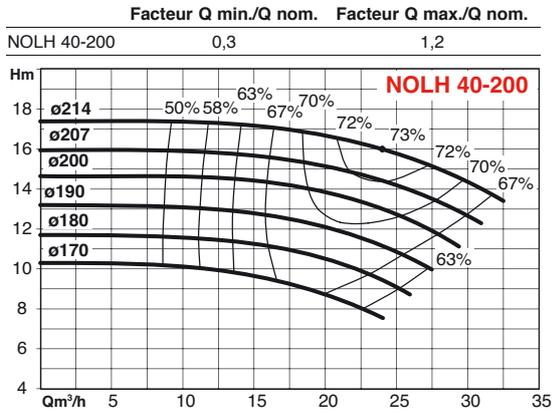

NOLH

PERFORMANCES HYDRAULIQUES

1450 MIN⁻¹

Facteur Q min./Q nom. 0,3 Facteur Q max./Q nom. 1,2
NOLH 50-160

Facteur Q min./Q nom. 0,3 Facteur Q max./Q nom. 1,1
NOLH 50-200

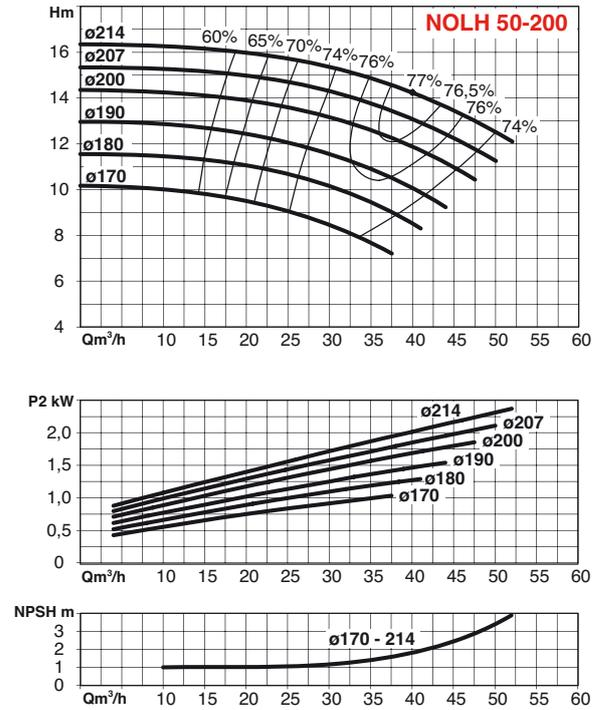
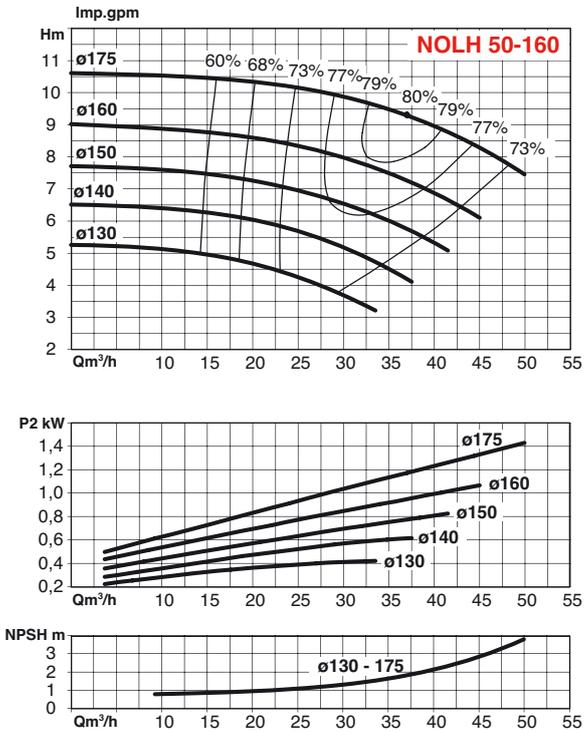

Facteur Q min./Q nom. 0,3 Facteur Q max./Q nom. 1,2
NOLH 50-250

Facteur Q min./Q nom. 0,3 Facteur Q max./Q nom. 1,2
NOLH 50-315

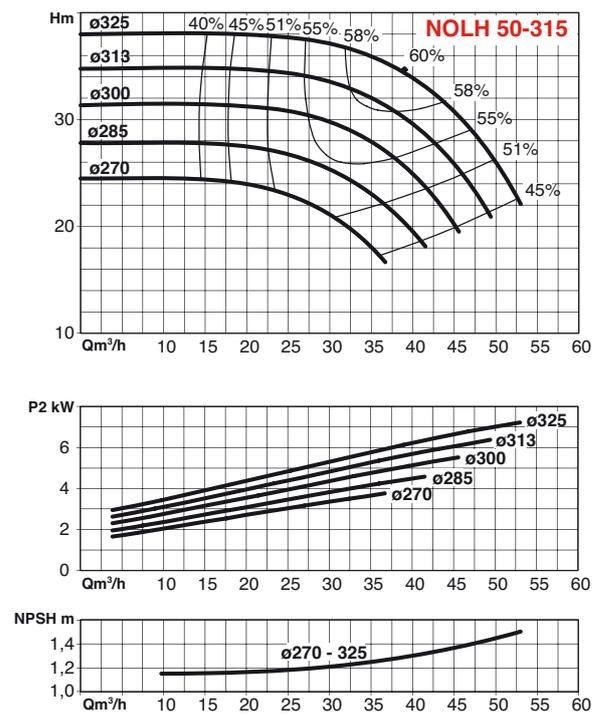
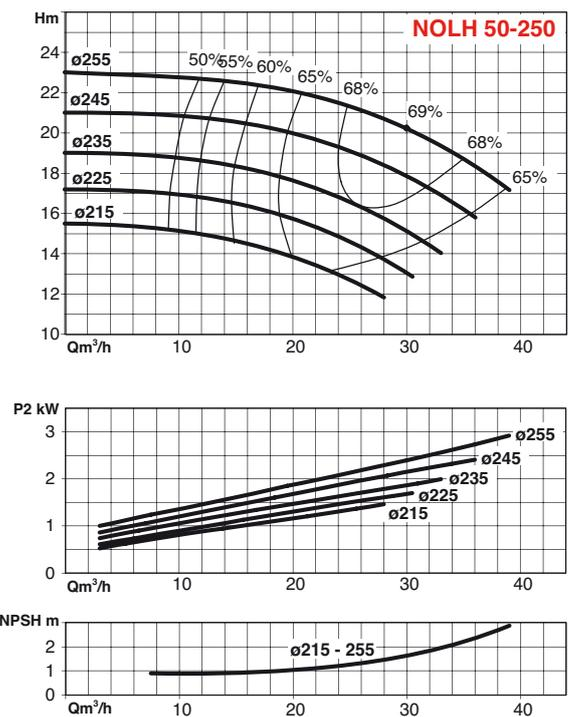

PERFORMANCES HYDRAULIQUES

1450 MIN⁻¹

Facteur Q min./Q nom. 0,3 Facteur Q max./Q nom. 1,2
NOLH 65-125

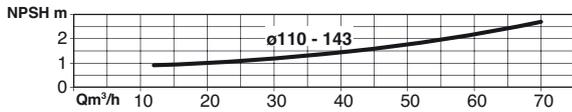
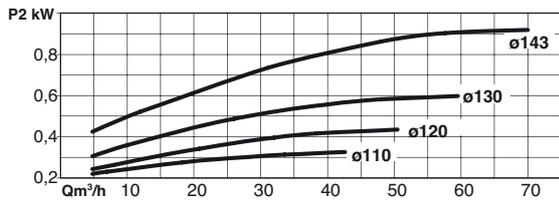
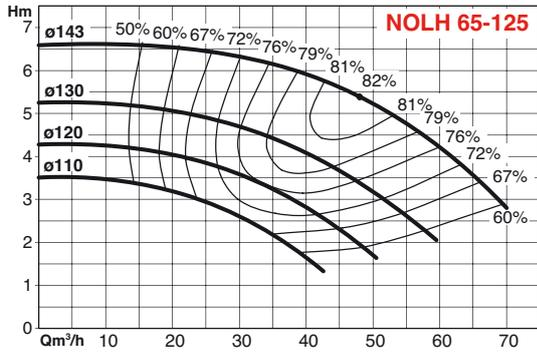

Facteur Q min./Q nom. 0,3 Facteur Q max./Q nom. 1,2
NOLH 65-160

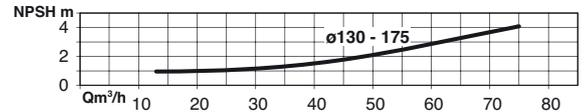
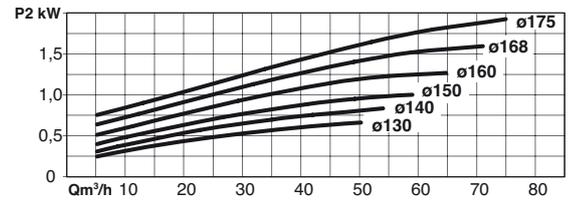
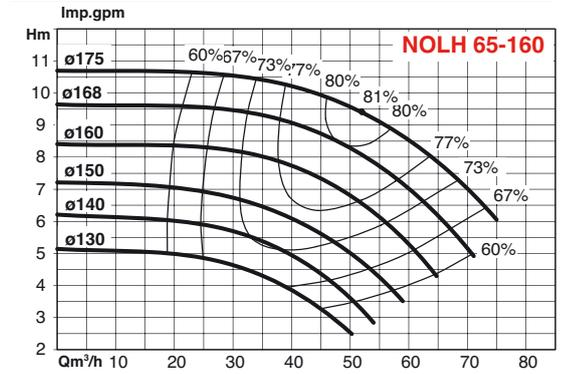

Facteur Q min./Q nom. 0,3 Facteur Q max./Q nom. 1,2
NOLH 65-200

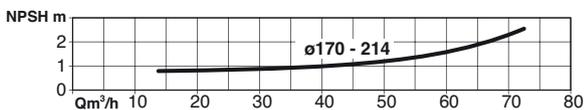
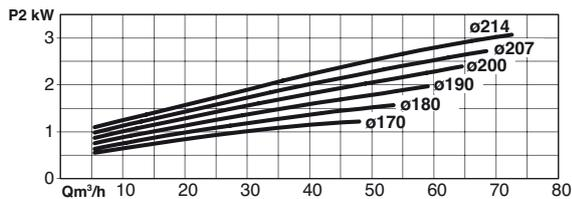
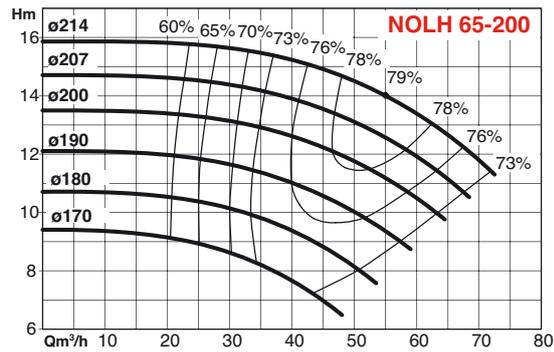

Facteur Q min./Q nom. 0,3 Facteur Q max./Q nom. 1,1
NOLH 65-250

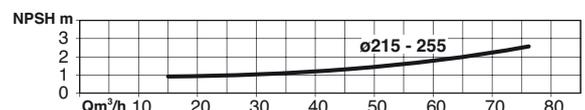
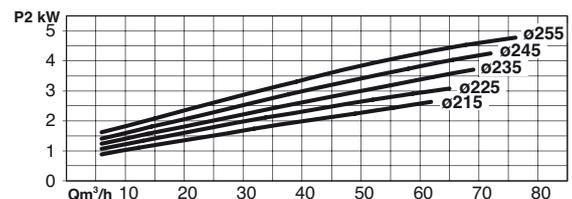
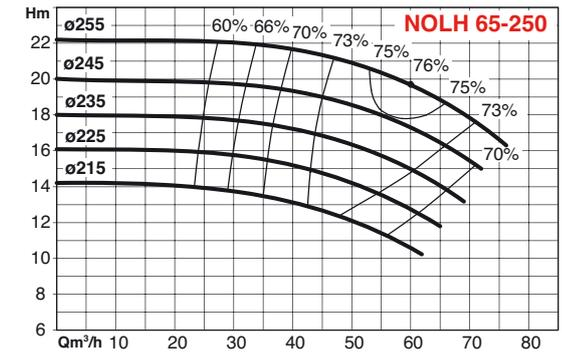

NOLH

PERFORMANCES HYDRAULIQUES

1450 MIN⁻¹

Facteur Q min./Q nom. Facteur Q max./Q nom.
NOLH 65-315 0,3 1,2

Facteur Q min./Q nom. Facteur Q max./Q nom.
NOLH 80-160 0,3 1,2

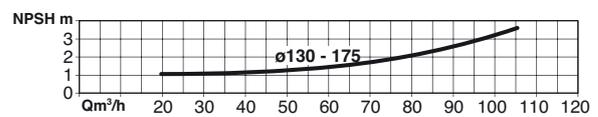
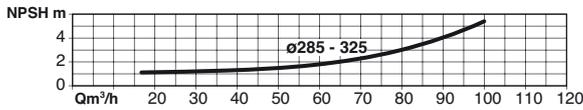
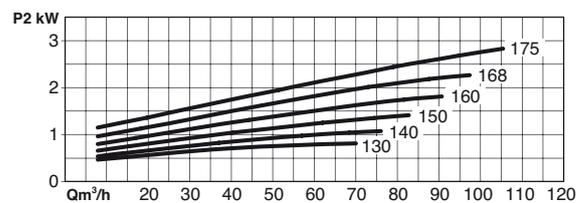
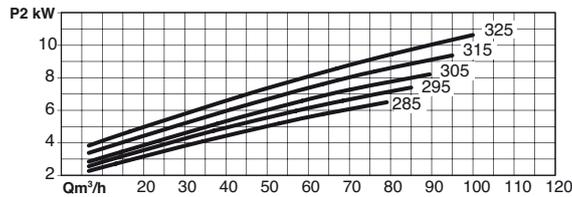
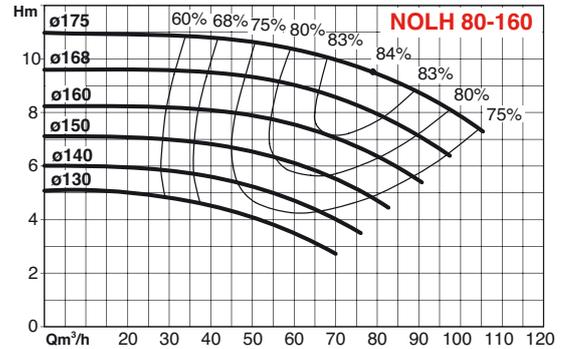
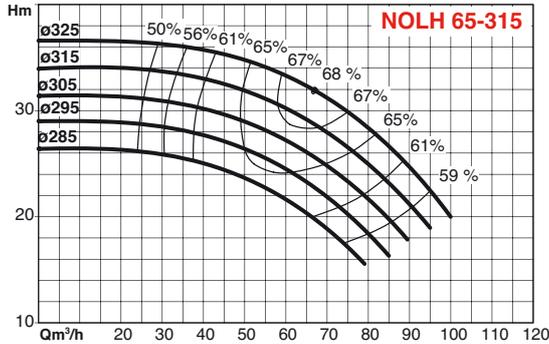

Facteur Q min./Q nom. Facteur Q max./Q nom.
NOLH 80-200 0,3 1,2

Facteur Q min./Q nom. Facteur Q max./Q nom.
NOLH 80-250 0,3 1,2

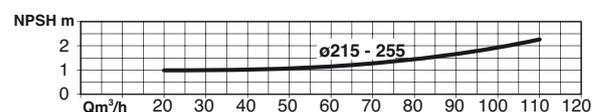
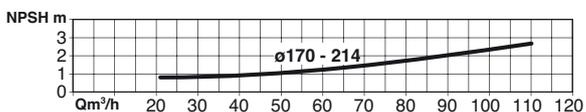
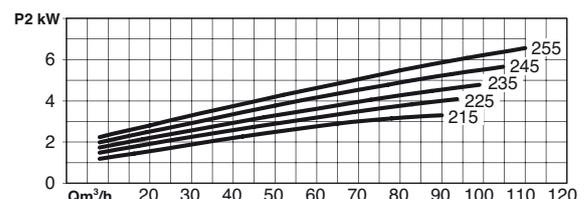
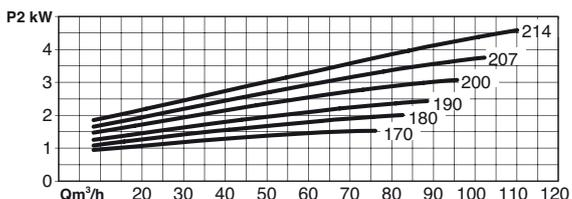
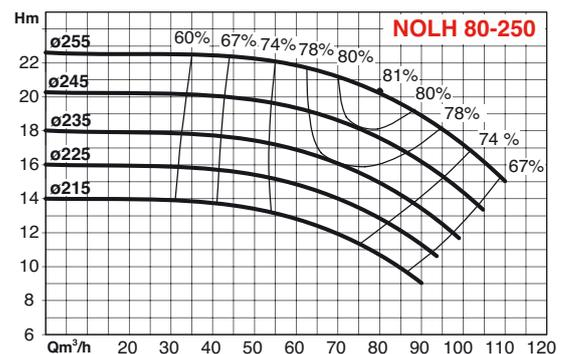
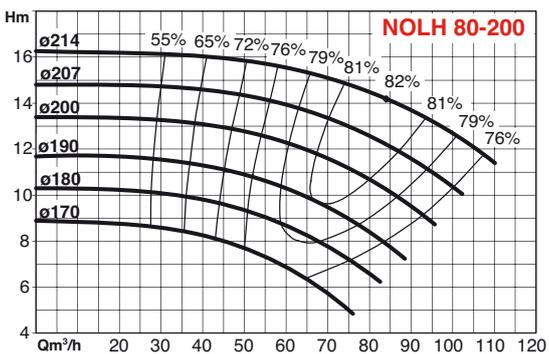

PERFORMANCES HYDRAULIQUES

1450 MIN⁻¹

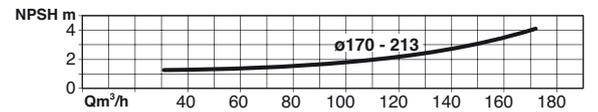
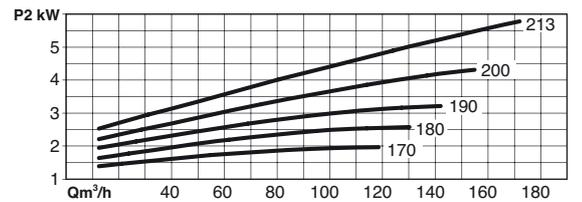
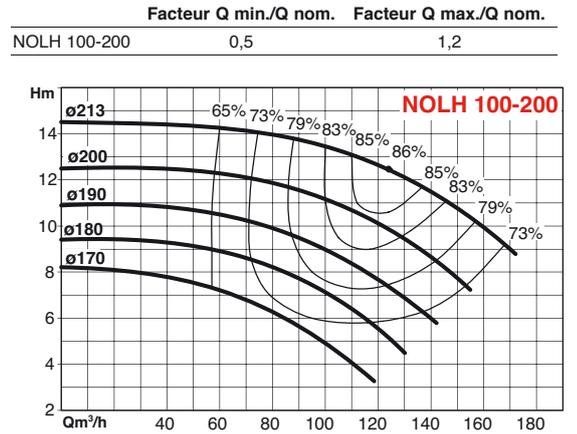
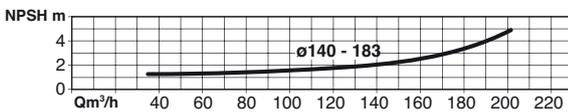
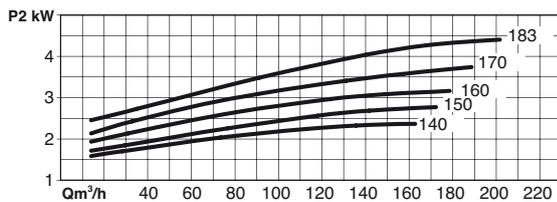
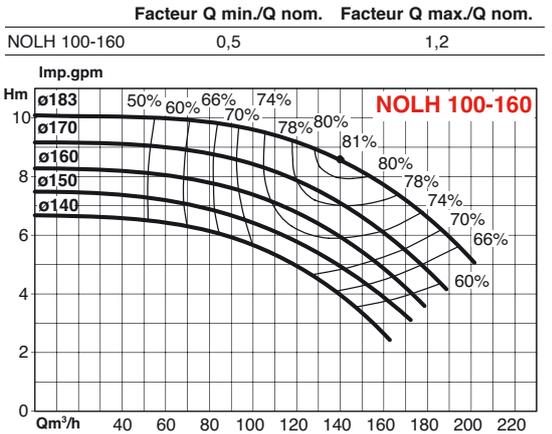
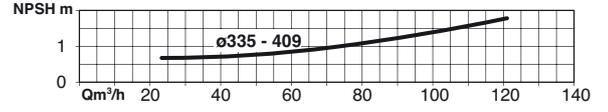
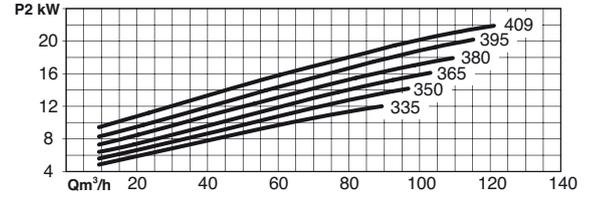
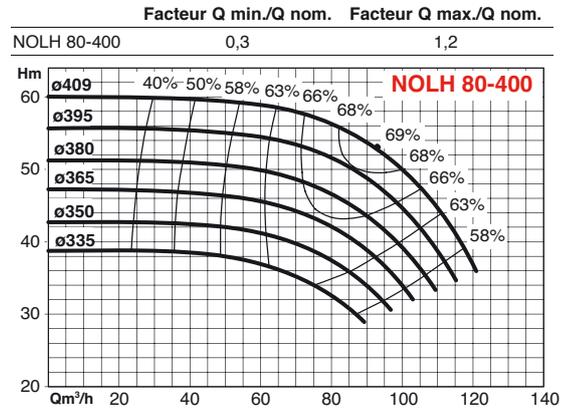
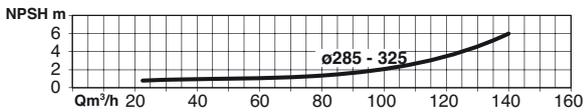
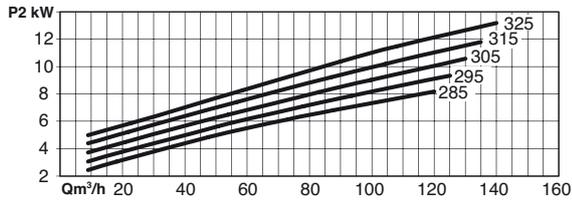
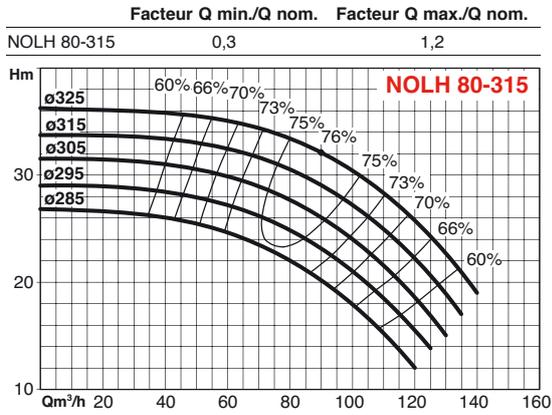

NOLH

PERFORMANCES HYDRAULIQUES 1450 MIN⁻¹

Facteur Q min./Q nom. Facteur Q max./Q nom.
NOLH 100-250 0,5 1,1

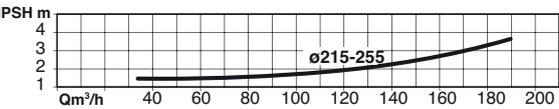
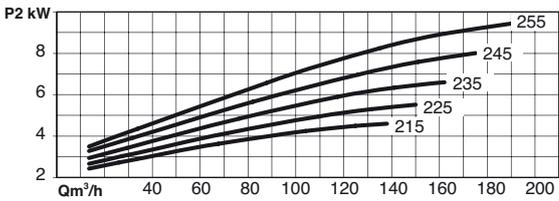
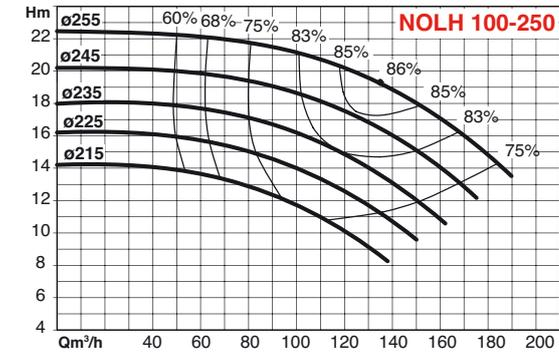

Facteur Q min./Q nom. Facteur Q max./Q nom.
NOLH 100-315 0,3 1,2

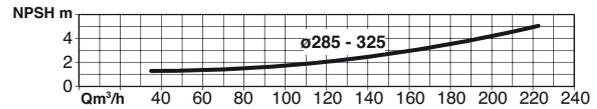
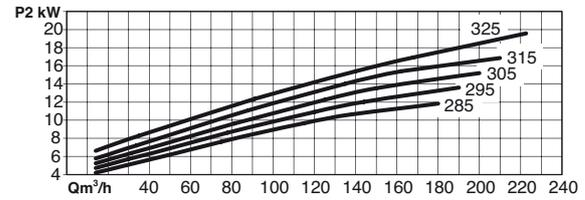
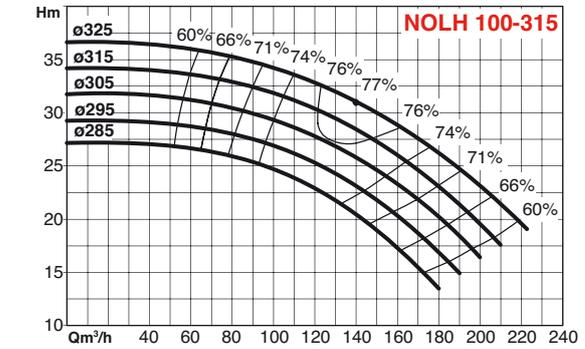

Facteur Q min./Q nom. Facteur Q max./Q nom.
NOLH 100-400 0,3 1,2

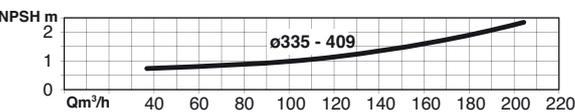
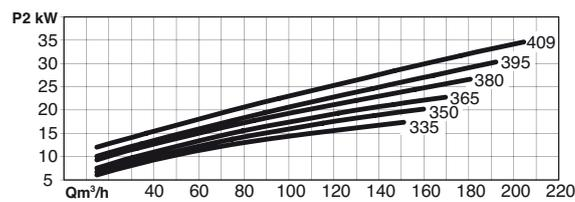
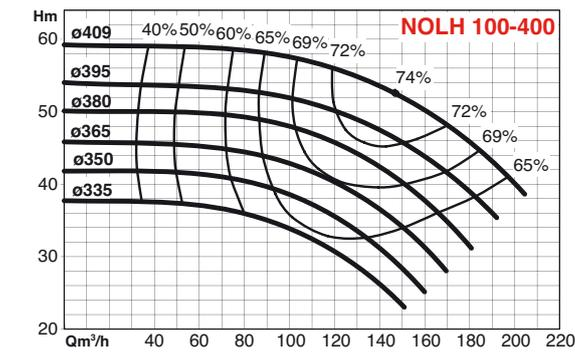

Facteur Q min./Q nom. Facteur Q max./Q nom.
NOLH 125-200 0,5 1,2

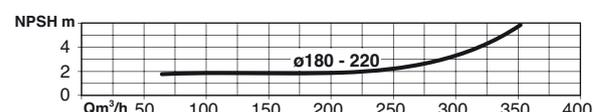
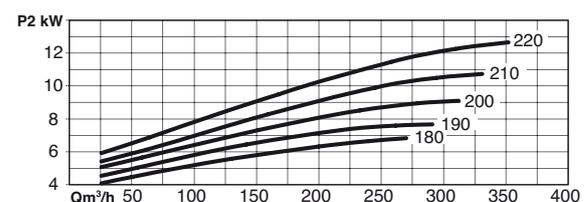
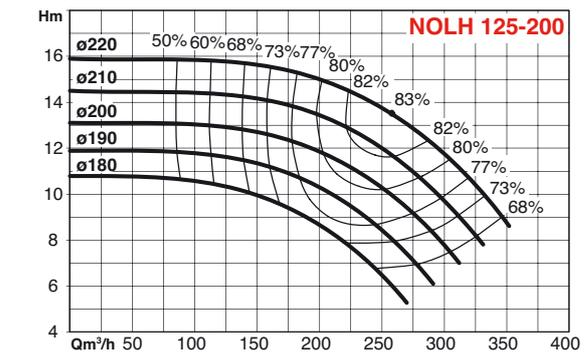

PERFORMANCES HYDRAULIQUES

1450 MIN⁻¹

Facteur Q min./Q nom. Facteur Q max./Q nom.
NOLH 125-250 0,5 1,2

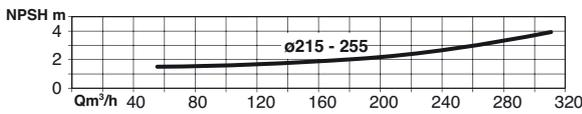
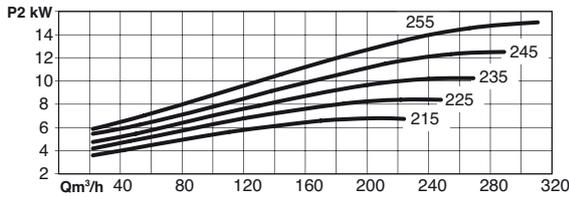
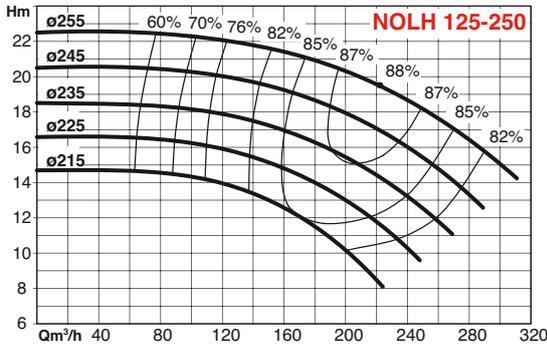

Facteur Q min./Q nom. Facteur Q max./Q nom.
NOLH 125-315 0,3 1,2

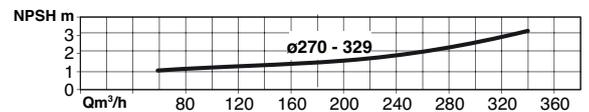
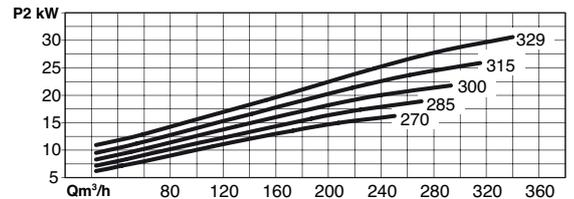
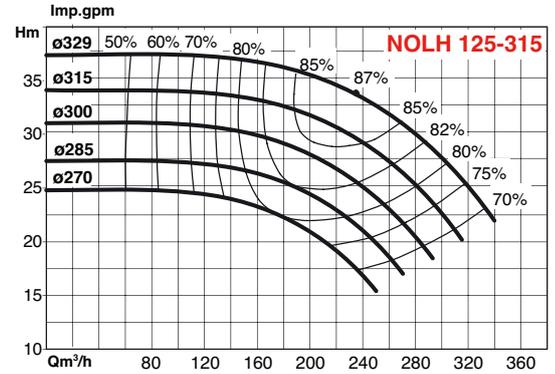

Facteur Q min./Q nom. Facteur Q max./Q nom.
NOLH 125-400 0,5 1,2

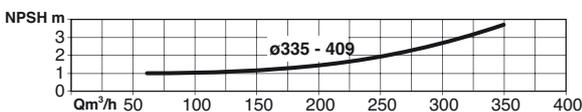
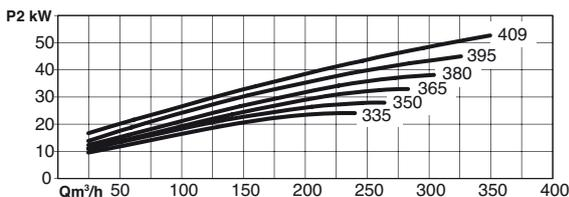
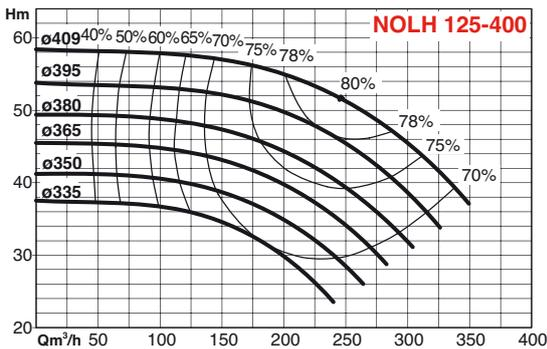

Facteur Q min./Q nom. Facteur Q max./Q nom.
NOLH 150-200 0,5 1,2

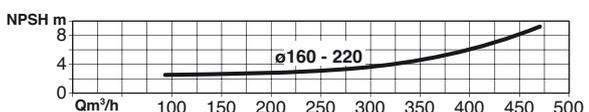
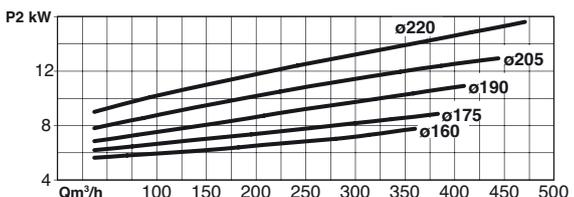
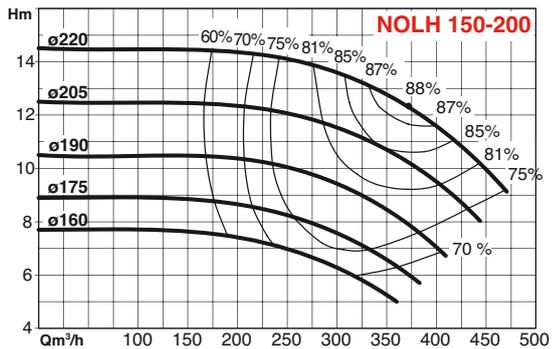

NOLH

PERFORMANCES HYDRAULIQUES 1450 MIN⁻¹

Facteur Q min./Q nom. Facteur Q max./Q nom.
NOLH 150-250 0,3 1,1

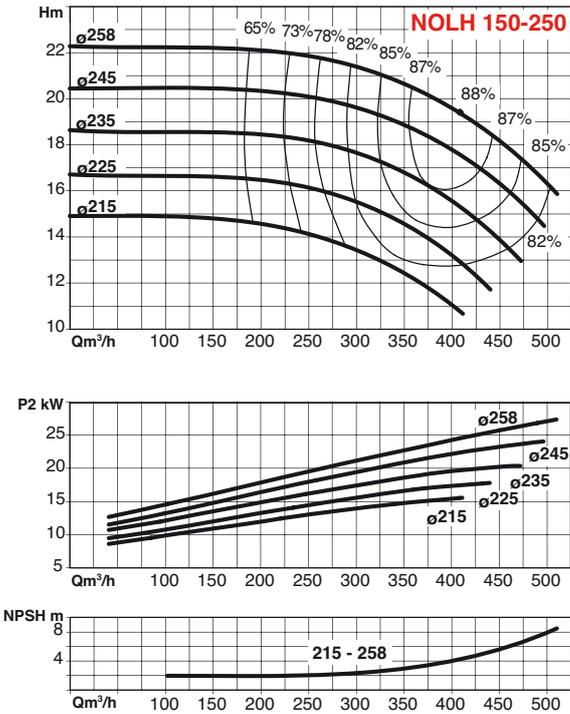

Facteur Q min./Q nom. Facteur Q max./Q nom.
NOLH 150-315 0,3 1,2

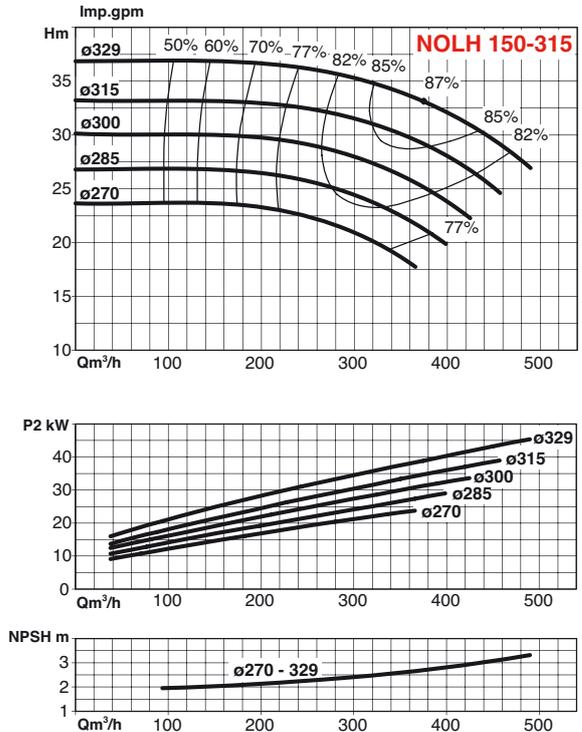

Facteur Q min./Q nom. Facteur Q max./Q nom.
NOLH 150-400 0,3 1,2

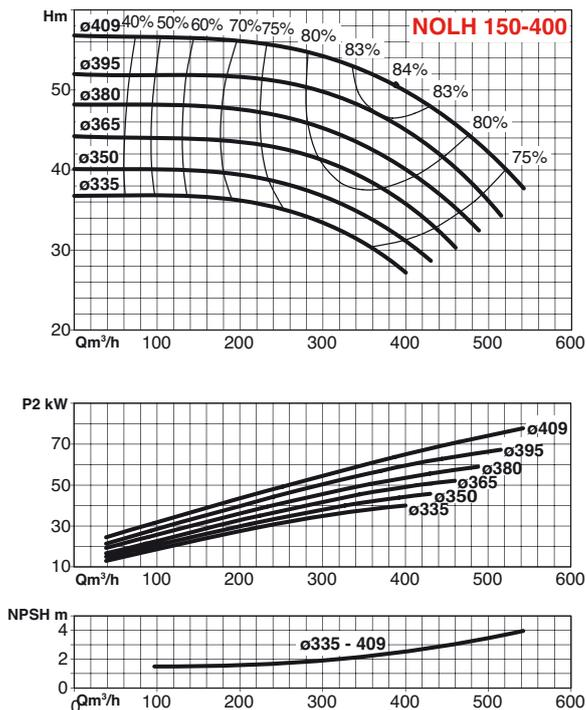

Facteur Q min./Q nom. Facteur Q max./Q nom.
NOLH 150-500 0,3 1,2

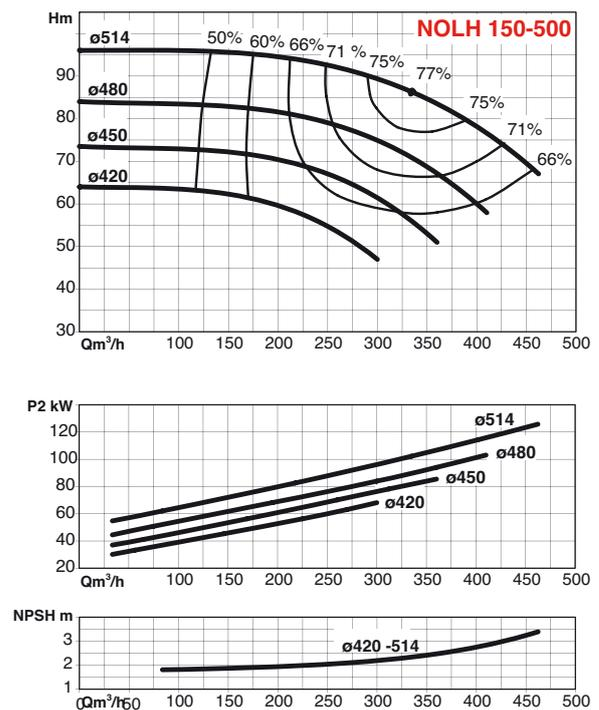

PERFORMANCES HYDRAULIQUES

1450 MIN⁻¹

Facteur Q min./Q nom. Facteur Q max./Q nom.
NOLH 200-250 0,7 1,2

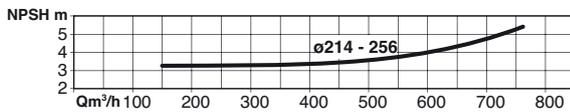
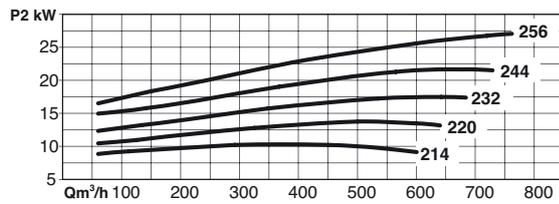
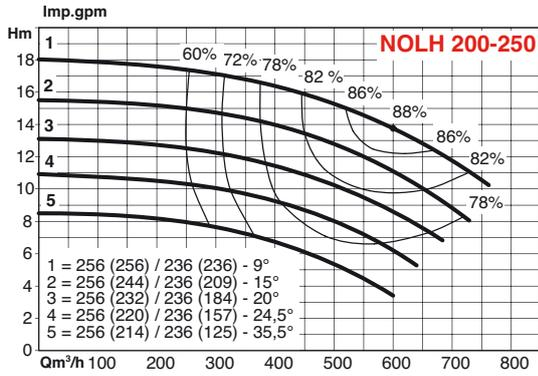

Facteur Q min./Q nom. Facteur Q max./Q nom.
NOLH 200-315 0,7 1,2

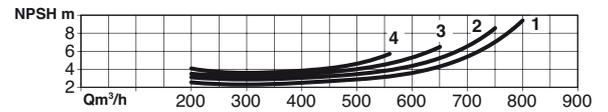
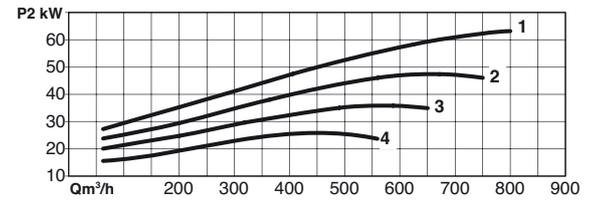
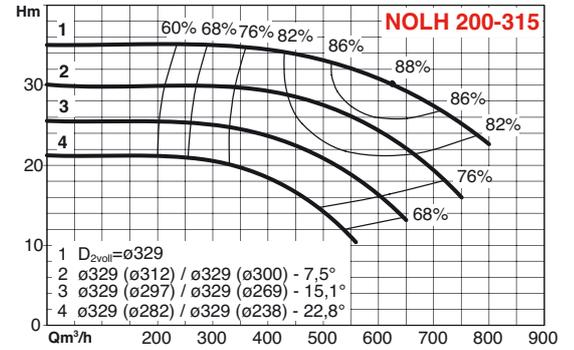

Facteur Q min./Q nom. Facteur Q max./Q nom.
NOLH 200-400 0,7 1,2

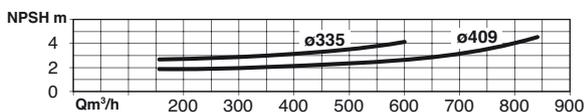
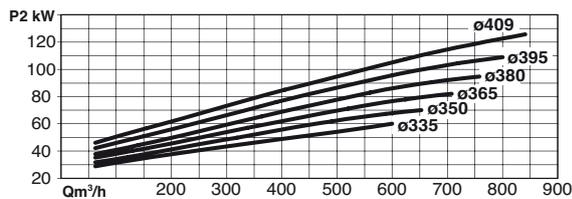
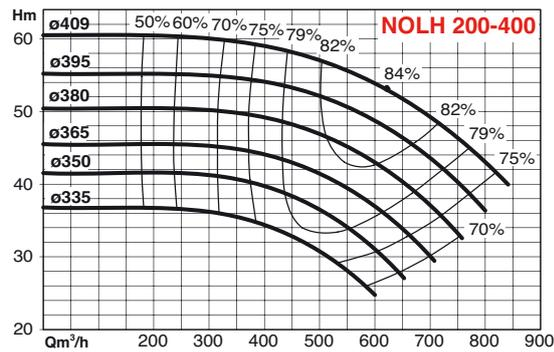

Facteur Q min./Q nom. Facteur Q max./Q nom.
NOLH 200-500 0,5 1,2

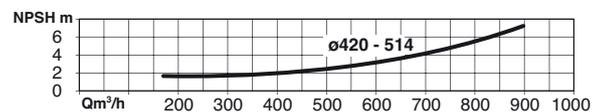
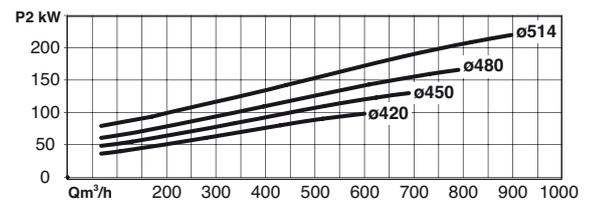
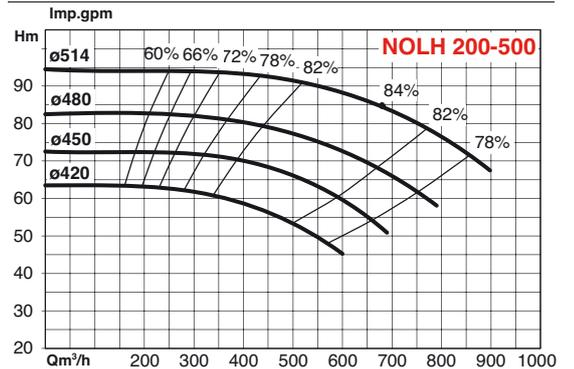

NOLH

PERFORMANCES HYDRAULIQUES 1450 MIN⁻¹

Facteur Q min./Q nom. Facteur Q max./Q nom.
NOLH 250-300 0,5 1,2

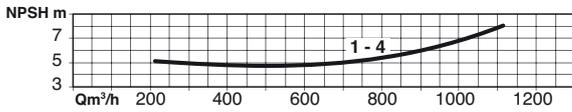
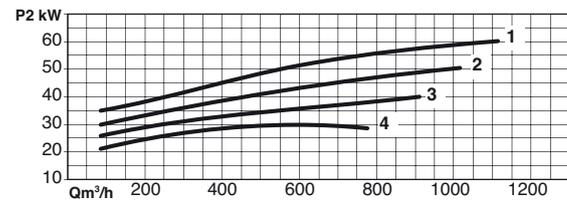
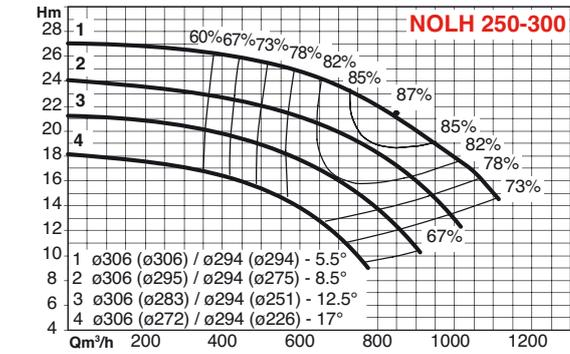

Facteur Q min./Q nom. Facteur Q max./Q nom.
NOLH 250-315 0,5 1,2

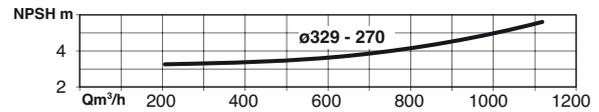
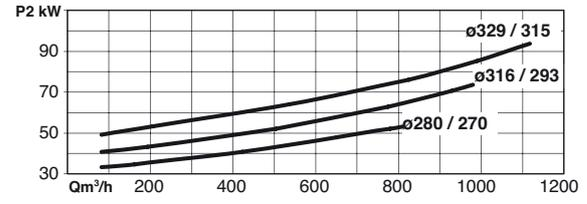
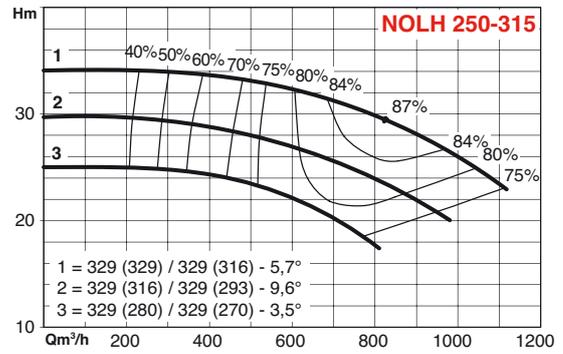

Facteur Q min./Q nom. Facteur Q max./Q nom.
NOLH 250-400 0,5 1,2

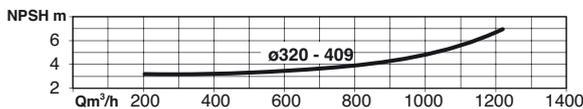
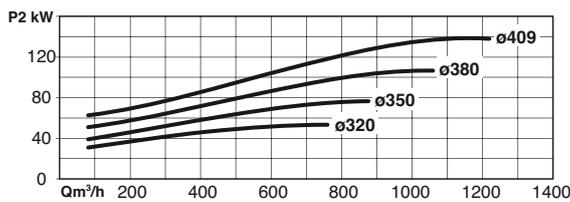
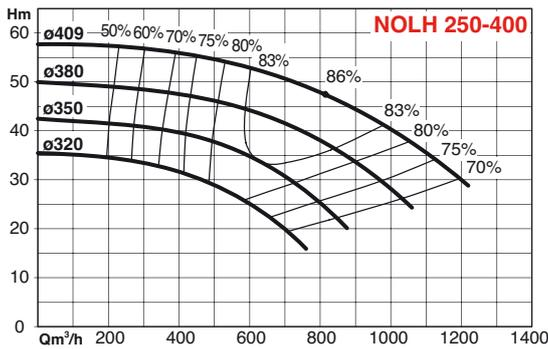

Facteur Q min./Q nom. Facteur Q max./Q nom.
NOLH 250-500 0,5 1,1

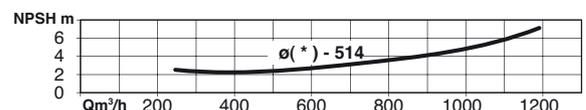
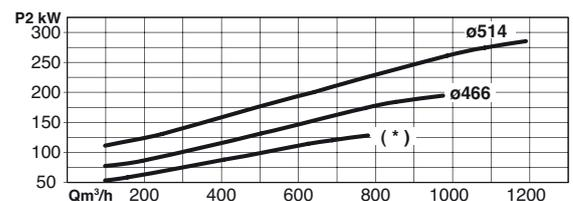
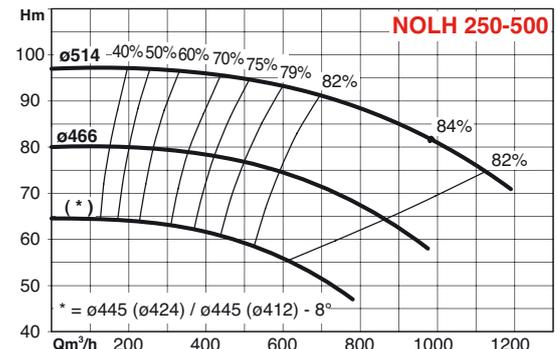

PERFORMANCES HYDRAULIQUES **1450 MIN⁻¹**

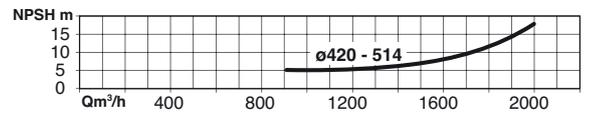
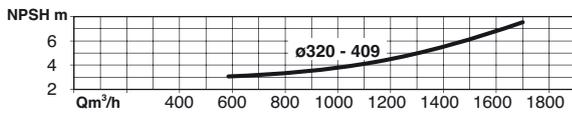
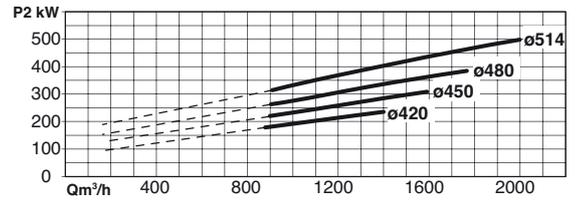
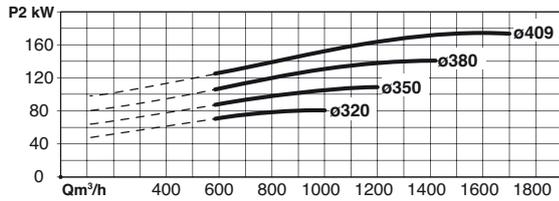
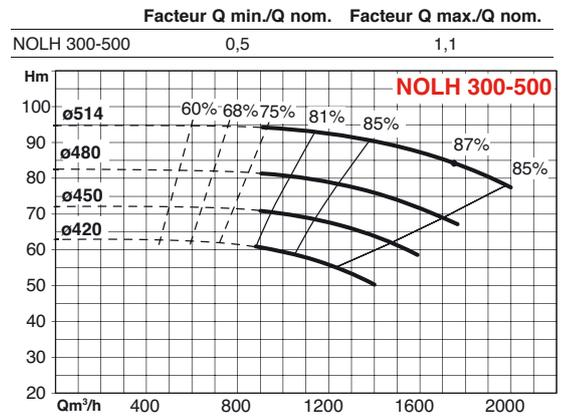
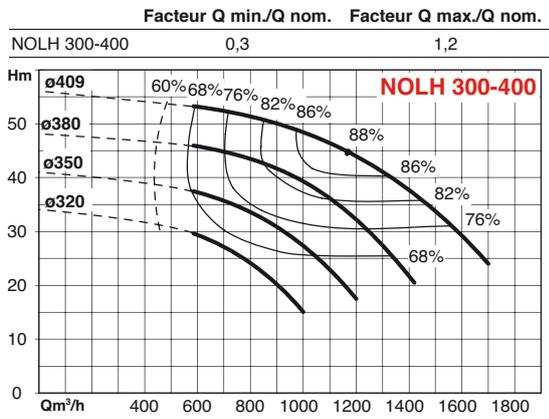

NOLH

PERFORMANCES HYDRAULIQUES 2900 MIN⁻¹

NOLH 32-125	Facteur Q min./Q nom.	Facteur Q max./Q nom.
	0,3	1,2

NOLH 32-160A	Facteur Q min./Q nom.	Facteur Q max./Q nom.
	0,3	1,2

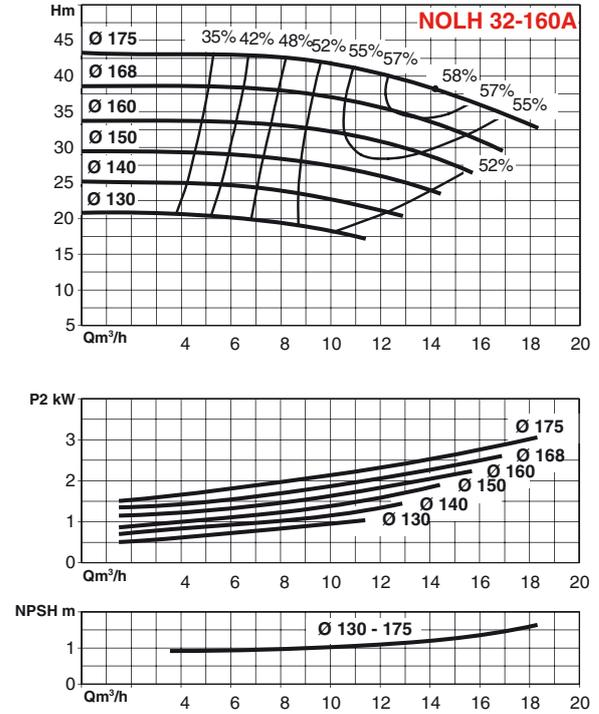
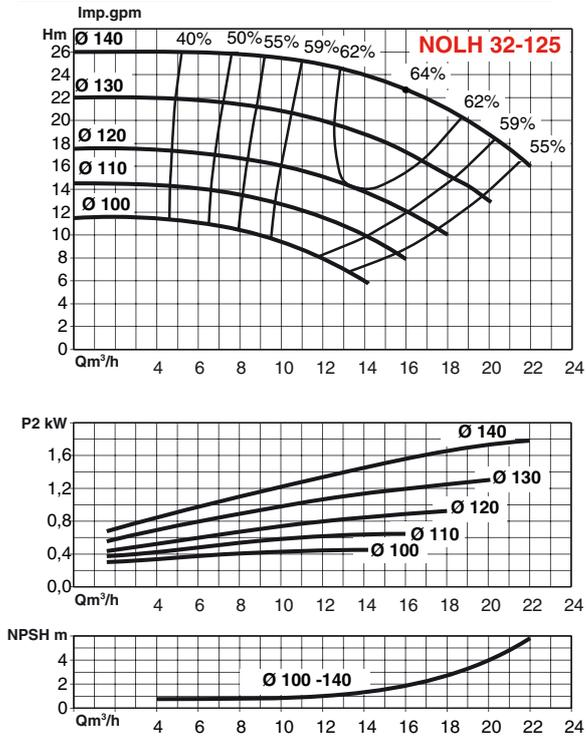

NOLH 32-160B	Facteur Q min./Q nom.	Facteur Q max./Q nom.
	0,3	1,2

NOLH 32-200A	Facteur Q min./Q nom.	Facteur Q max./Q nom.
	0,3	1,2

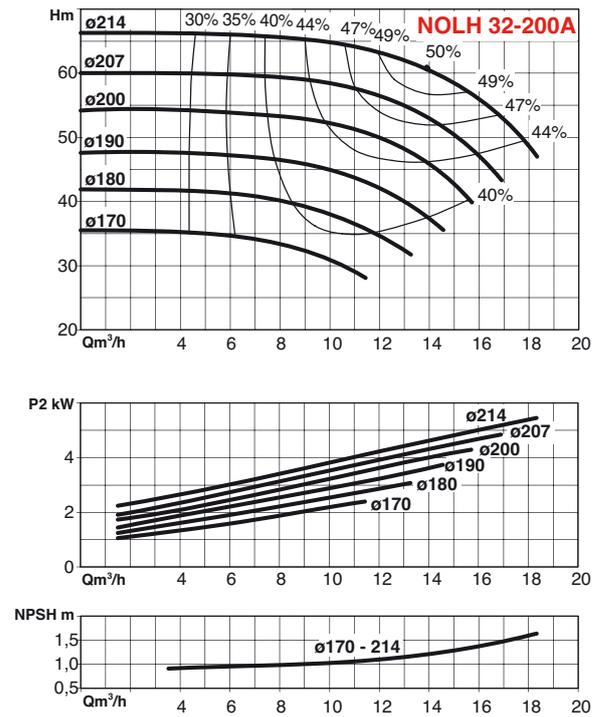
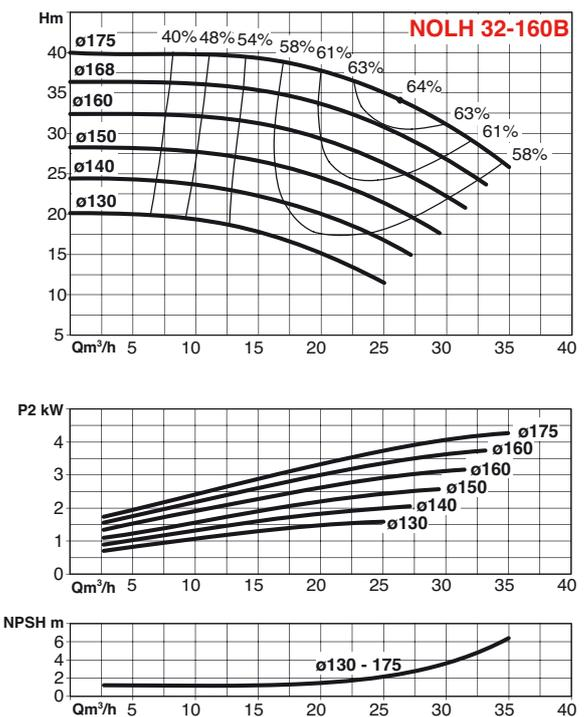

PERFORMANCES HYDRAULIQUES

2900 MIN⁻¹

Facteur Q min./Q nom. 0,3 Facteur Q max./Q nom. 1,2
 NOLH 32-200B

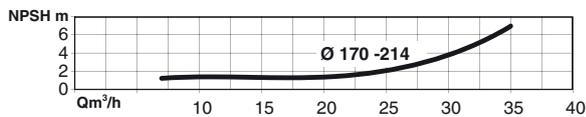
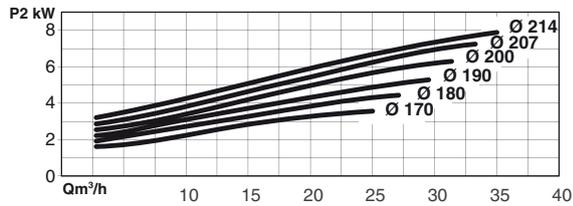
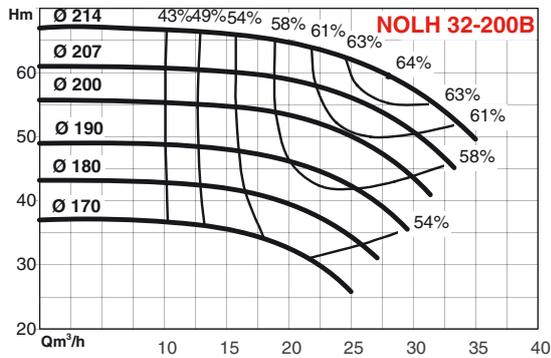

Facteur Q min./Q nom. 0,3 Facteur Q max./Q nom. 1,1
 NOLH 32-250

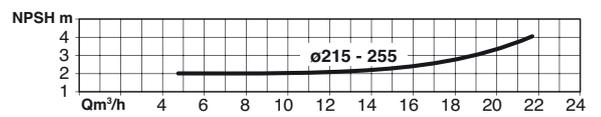
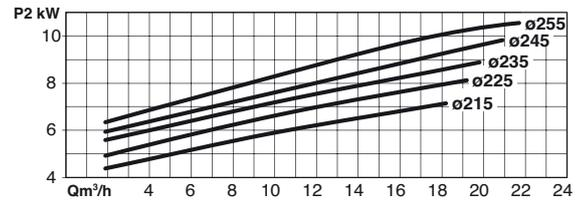
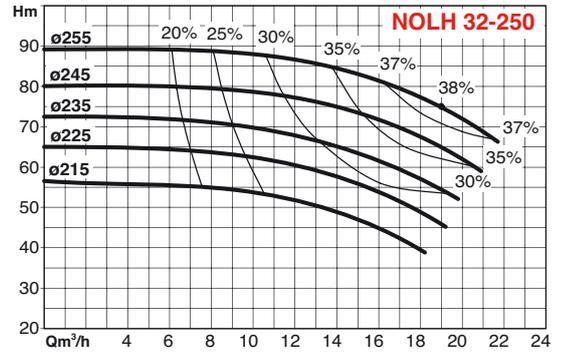

Facteur Q min./Q nom. 0,3 Facteur Q max./Q nom. 1,2
 NOLH 40-125

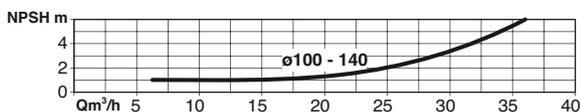
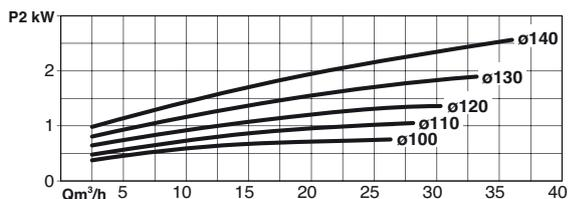
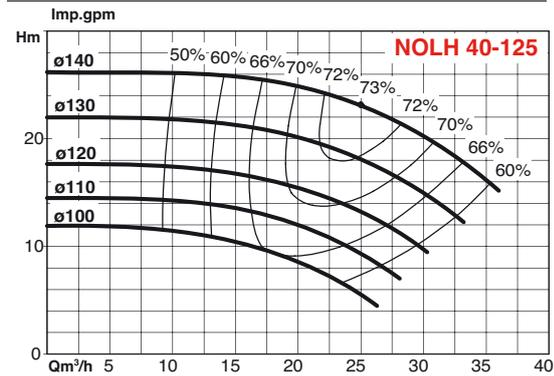

Facteur Q min./Q nom. 0,3 Facteur Q max./Q nom. 1,2
 NOLH 40-160

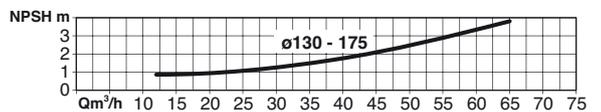
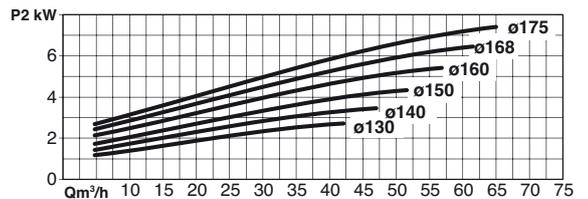
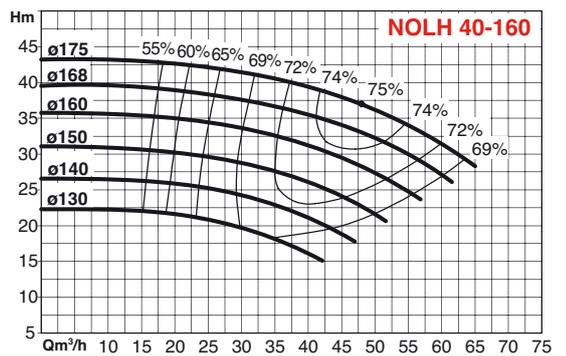

NOLH

PERFORMANCES HYDRAULIQUES 2900 MIN⁻¹

Facteur Q min./Q nom. Facteur Q max./Q nom.
NOLH 40-200 0,3 1,2

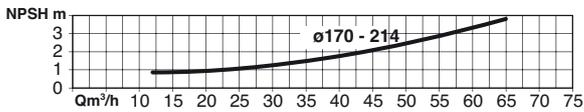
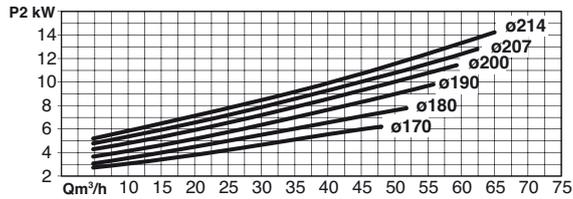
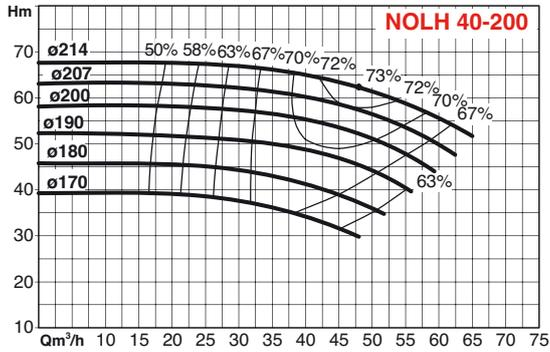

Facteur Q min./Q nom. Facteur Q max./Q nom.
NOLH 40-250 0,3 1,1

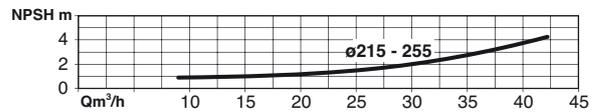
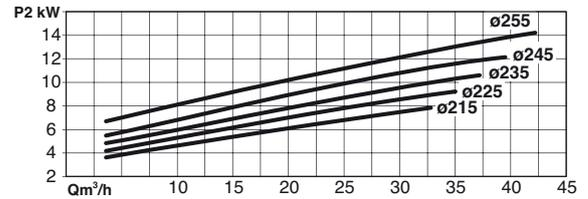
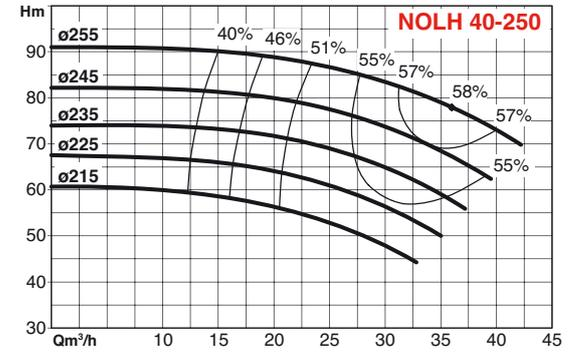

Facteur Q min./Q nom. Facteur Q max./Q nom.
NOLH 40-315 0,3 1,1

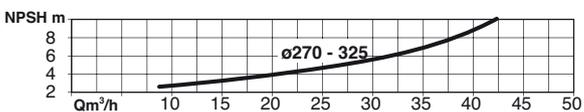
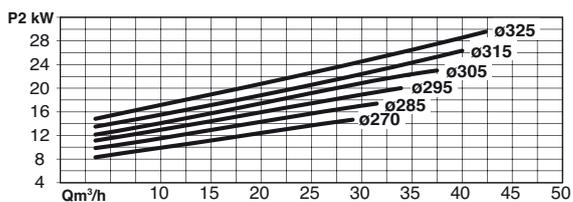
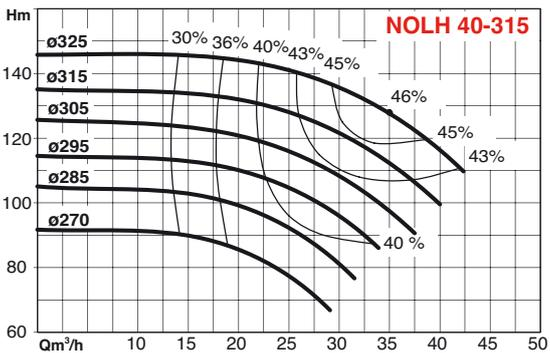

Facteur Q min./Q nom. Facteur Q max./Q nom.
NOLH 50-125 0,3 1,2

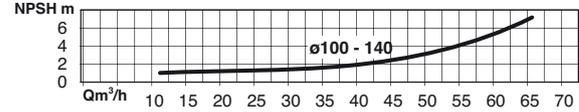
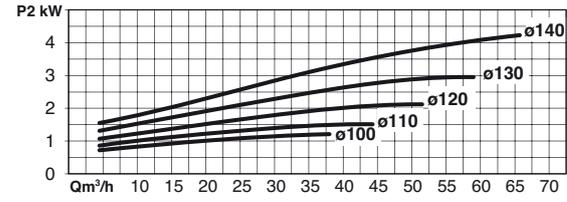
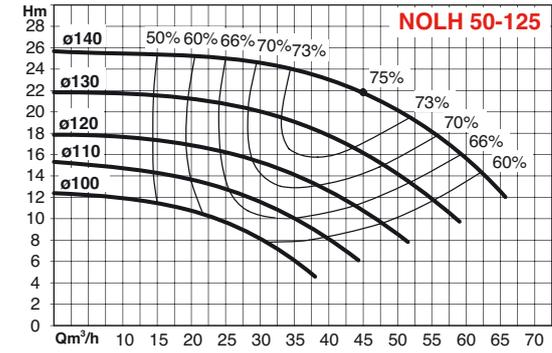

PERFORMANCES HYDRAULIQUES

2900 MIN⁻¹

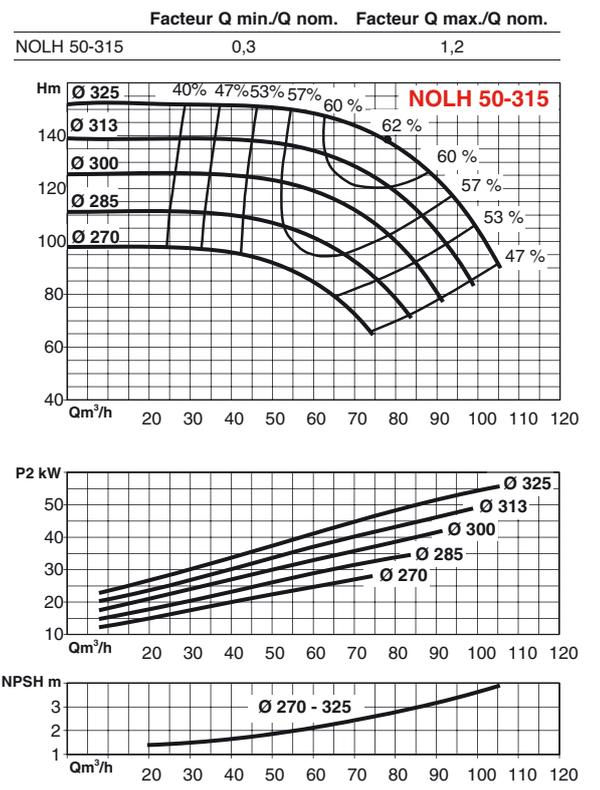
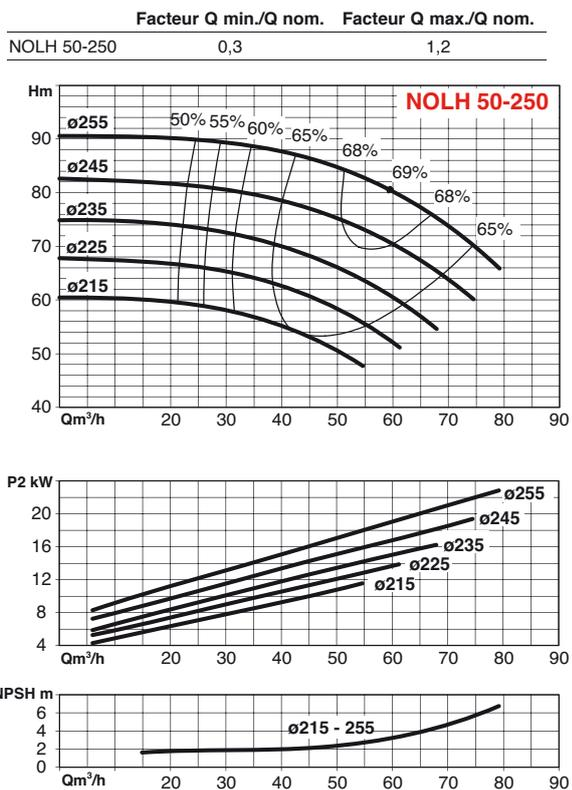
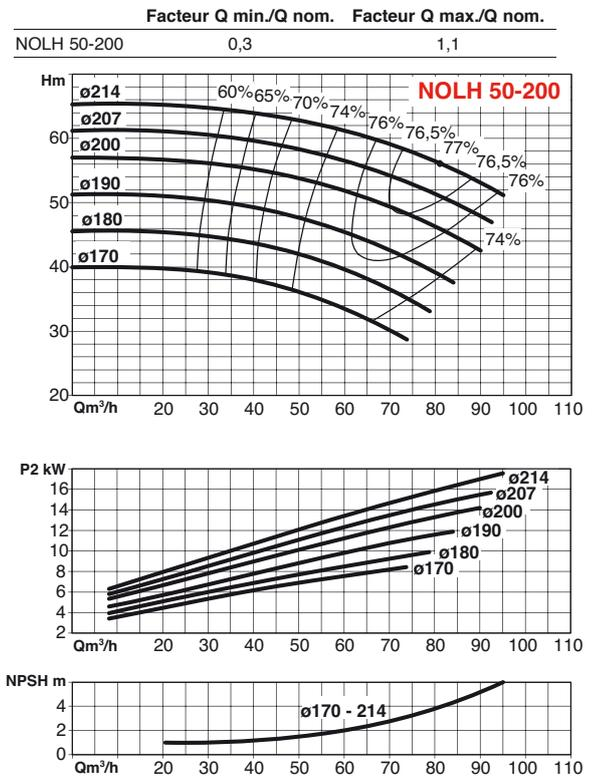
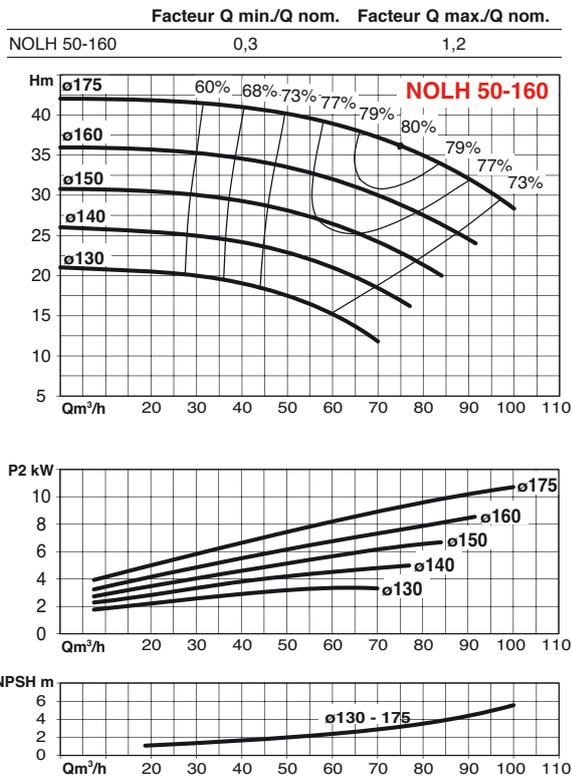

NOLH

PERFORMANCES HYDRAULIQUES

2900 MIN⁻¹

Facteur Q min./Q nom. Facteur Q max./Q nom.
NOLH 65-125 0,3 1,2

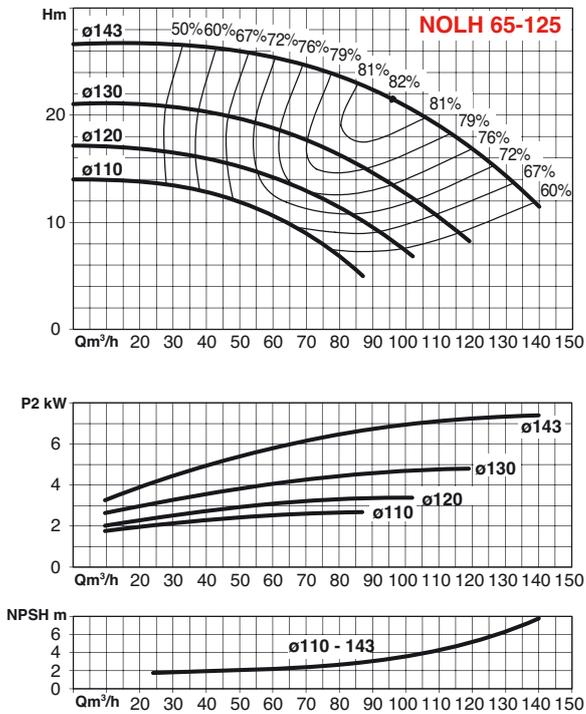

Facteur Q min./Q nom. Facteur Q max./Q nom.
NOLH 65-160 0,3 1,2

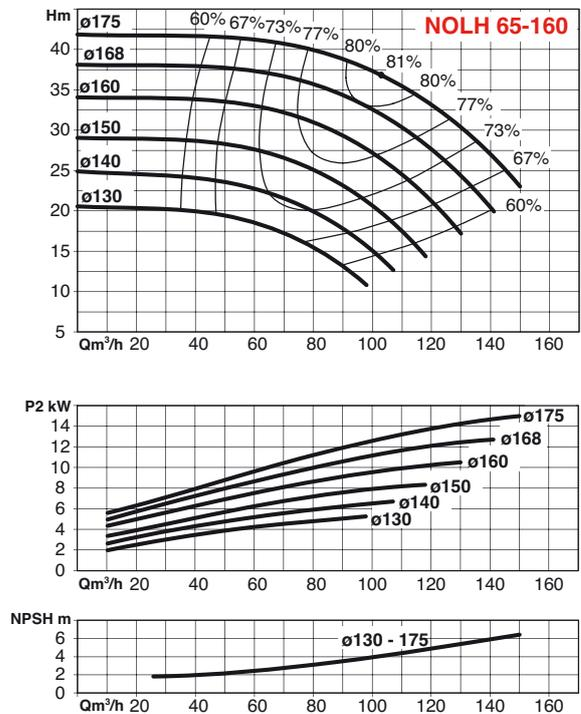

Facteur Q min./Q nom. Facteur Q max./Q nom.
NOLH 65-200 0,3 1,2

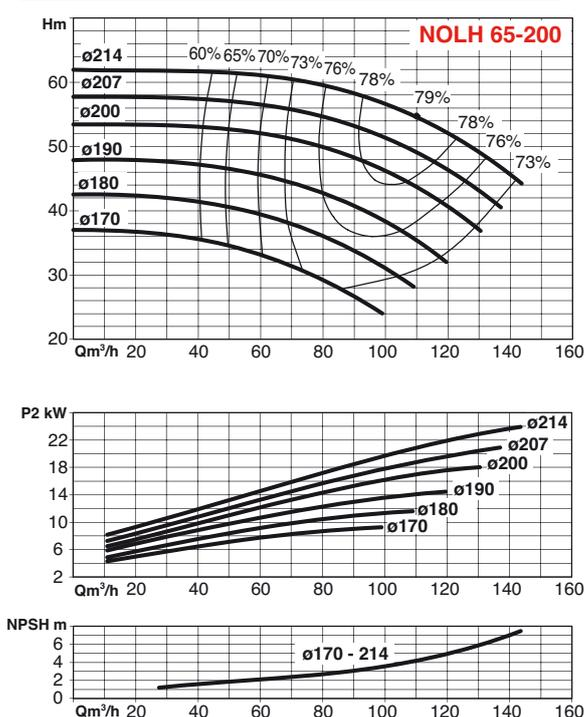

Facteur Q min./Q nom. Facteur Q max./Q nom.
NOLH 65-250 0,3 1,1

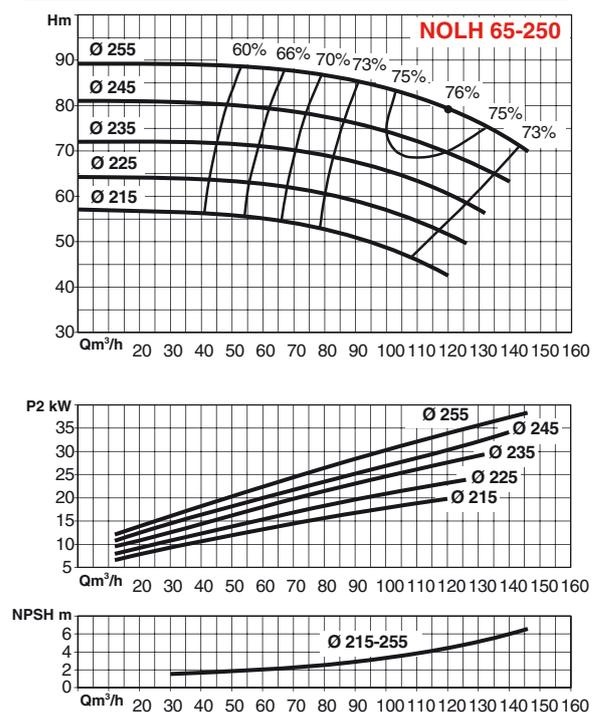

PERFORMANCES HYDRAULIQUES

2900 MIN⁻¹

Facteur Q min./Q nom. 0,3 Facteur Q max./Q nom. 1,2
NOLH 80-160

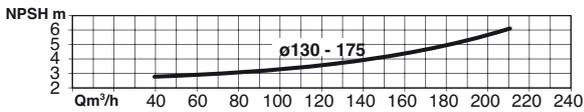
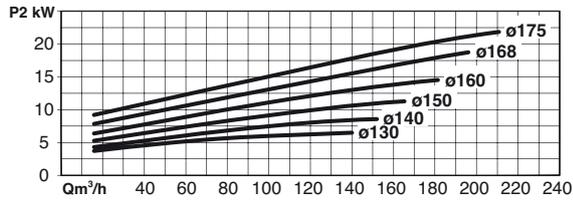
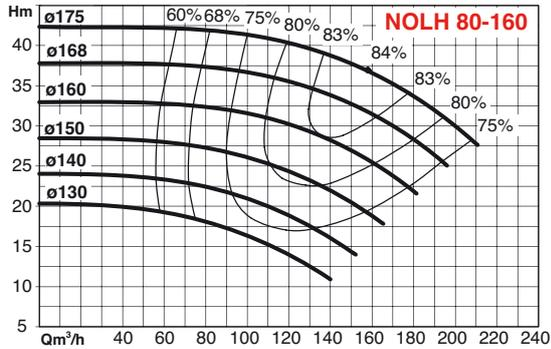

Facteur Q min./Q nom. 0,3 Facteur Q max./Q nom. 1,2
NOLH 80-200

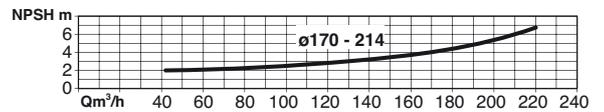
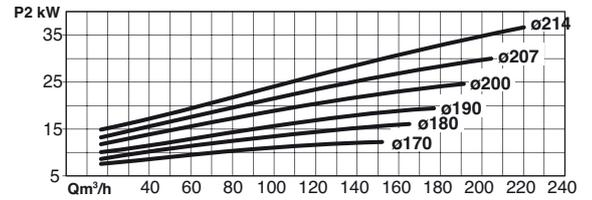
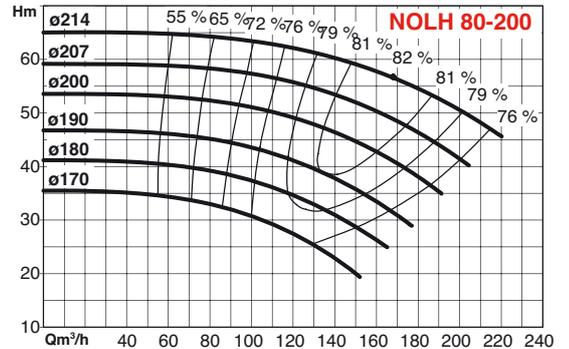

Facteur Q min./Q nom. 0,3 Facteur Q max./Q nom. 1,2
NOLH 80-250

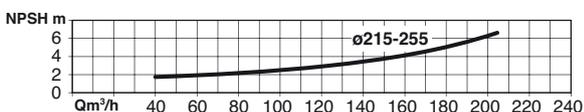
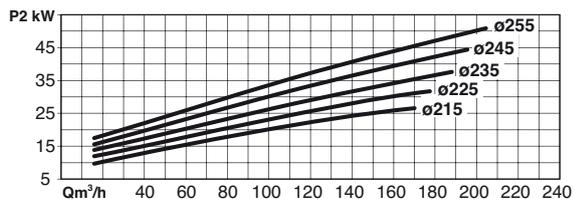
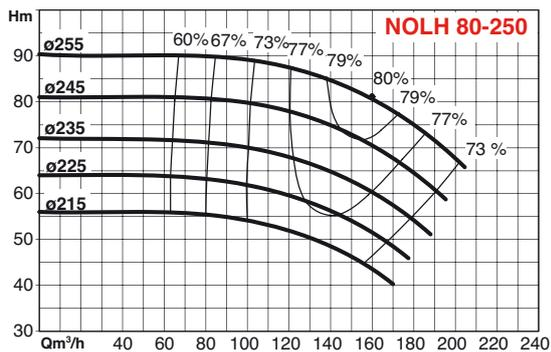

Facteur Q min./Q nom. 0,5 Facteur Q max./Q nom. 1,2
NOLH 100-160

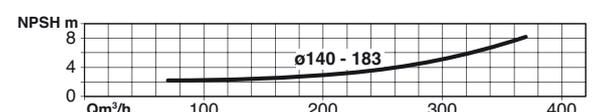
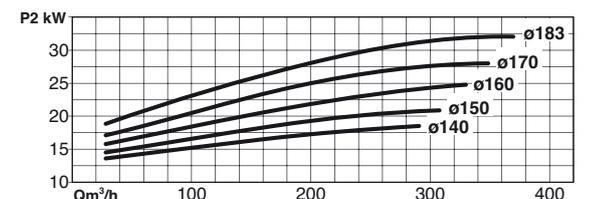
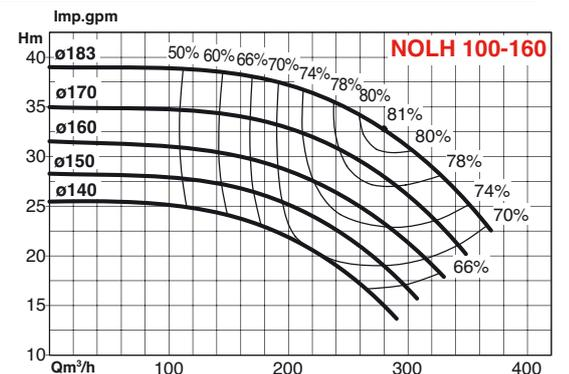

NOLH

PERFORMANCES HYDRAULIQUES 2900 MIN⁻¹

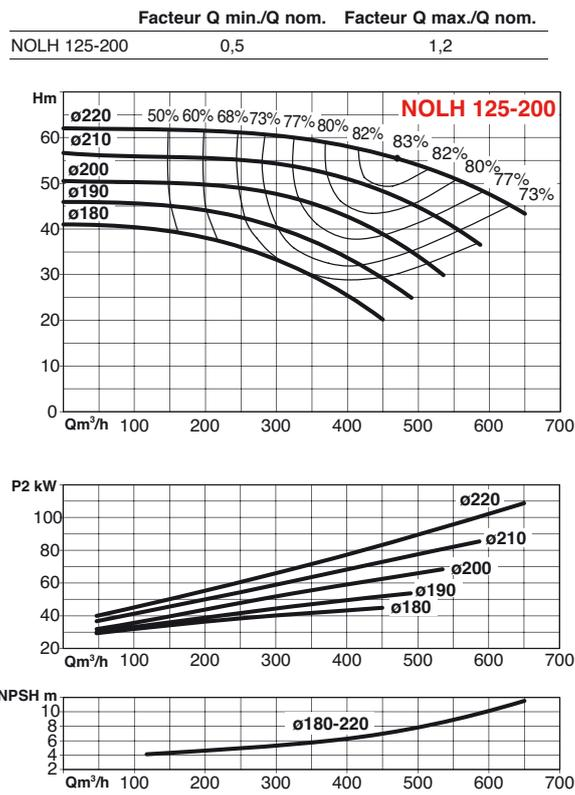
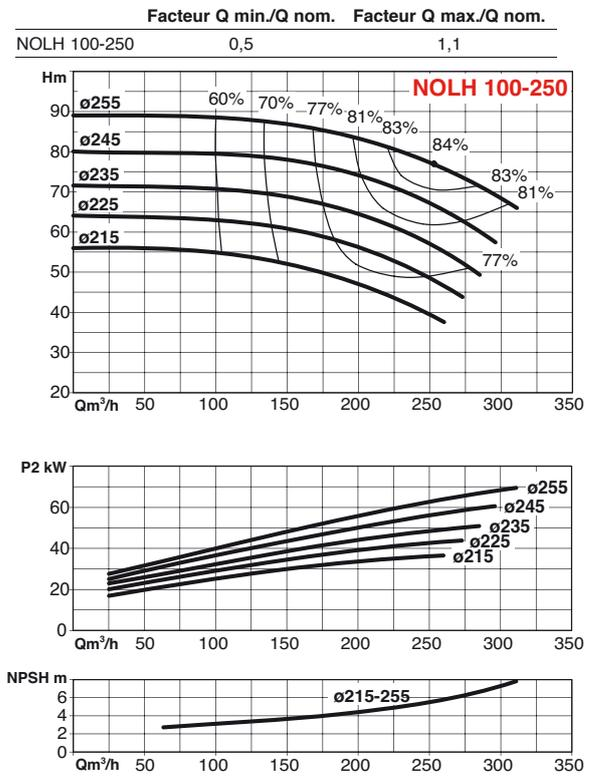
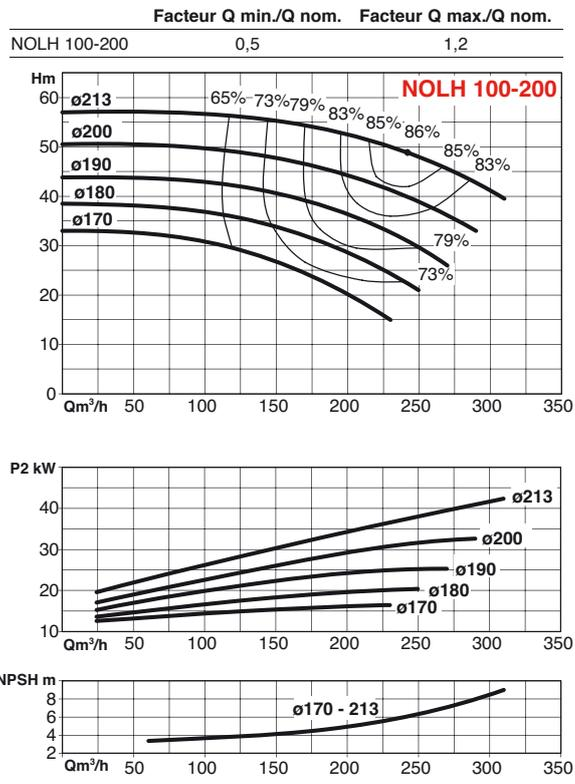

DIMENSIONS – POMPE ARBRE NU

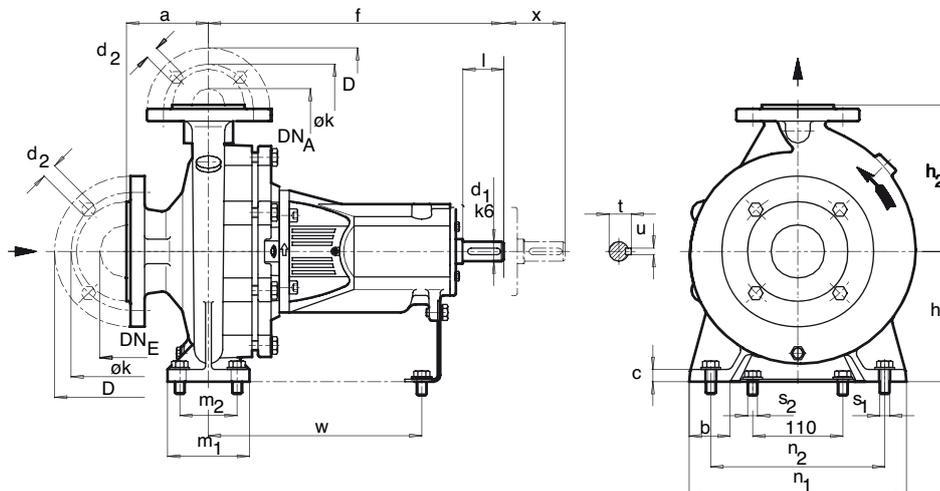

Modèle	Palier	Dimensions pompes								Dimensions pattes/support						Bout d'arbre					
		DNA	DNE	a	f	h1	h2	b	c	m1	m2	n1	n2	s1*	s2*	w	x	d1	l	t	u
32125	25	32	50	80	360	112	140	50	15	100	70	190	140	M12	M12	260	100	24	50	27	8
32160	25	32	50	80	360	132	160	50	15	100	70	240	190	M12	M12	260	100	24	50	27	8
32200	25	32	50	80	360	160	180	50	15	100	70	240	190	M12	M12	260	100	24	50	27	8
32250 ¹⁾	25	32	50	100	360	180	225	65	15	125	95	320	250	M12	M12	260	100	24	50	27	8
40125	25	40	65	80	360	112	140	50	15	100	70	210	160	M12	M12	260	100	24	50	27	8
40160	25	40	65	80	360	132	160	50	15	100	70	240	190	M12	M12	260	100	24	50	27	8
40200	25	40	65	100	360	160	180	50	15	100	70	265	212	M12	M12	260	100	24	50	27	8
40250	25	40	65	100	360	180	225	65	15	125	95	320	250	M12	M12	260	100	24	50	27	8
40315 ¹⁾	35	40	65	125	470	225	250	65	18	125	95	345	280	M12	M12	340	100	32	80	35	10
50125	25	50	65	100	360	132	160	50	15	100	70	240	190	M12	M12	260	100	24	50	27	8
50160	25	50	65	100	360	160	180	50	15	100	70	265	212	M12	M12	260	100	24	50	27	8
50200	25	50	65	100	360	160	200	50	15	100	70	265	212	M12	M12	260	100	24	50	27	8
50250	25	50	65	100	360	180	225	65	15	125	95	320	250	M12	M12	260	100	24	50	27	8
50315 ¹⁾	35	50	65	125	470	225	280	65	17	125	95	345	280	M12	M12	340	100	32	80	35	10
65125	25	65	80	100	360	160	180	65	15	125	95	280	212	M12	M12	260	100	24	50	27	8
65160	25	65	80	100	360	160	200	65	15	125	95	280	212	M12	M12	260	100	24	50	27	8
65200	25	65	80	100	360	180	225	65	15	125	95	320	250	M12	M12	260	140	24	50	27	8
65250	35	65	80	100	470	200	250	80	15	160	120	360	280	M16	M12	340	140	32	80	35	10
65315	35	65	80	125	470	225	280	80	18	160	120	400	315	M16	M12	340	140	32	80	35	10
80160	25	80	100	125	360	180	225	65	15	125	95	320	250	M12	M12	260	140	24	50	27	8
80200	35	80	100	125	470	180	250	65	15	125	95	345	280	M12	M12	340	140	32	80	35	10
80250	35	80	100	125	470	200	280	80	18	160	120	400	315	M16	M12	340	140	32	80	35	10
80315	35	80	100	125	470	250	315	80	18	160	120	400	315	M16	M12	340	140	32	80	35	10
80400 ¹⁾	45	80	125	125	530	280	355	80	18	160	120	435	355	M16	M12	370	140	42	110	45	12
100160 ¹⁾	35	100	125	125	470	200	280	80	18	160	120	360	280	M16	M12	340	140	32	80	35	10
100200	35	100	125	125	470	200	280	80	18	160	120	360	280	M16	M12	340	140	32	80	35	10
100250	35	100	125	140	470	225	280	80	18	160	120	400	315	M16	M12	340	140	32	80	35	10
100315	35	100	125	140	470	250	315	80	18	160	120	400	315	M16	M12	340	140	32	80	35	10
100400	45	100	125	140	530	280	355	100	18	200	150	500	400	M20	M12	370	140	42	110	45	12
125200 ¹⁾	35	125	150	140	470	250	315	80	18	160	120	400	315	M16	M12	340	140	32	80	35	10
125250	35	125	150	140	470	250	355	80	18	160	120	400	315	M16	M12	340	140	32	80	35	10
125315	45	125	150	140	530	280	355	100	18	200	150	500	400	M20	M12	370	140	42	110	45	12
125400	45	125	150	140	530	315	400	100	18	200	150	500	400	M20	M12	370	140	42	110	45	12
150200 ¹⁾	35	150	200	160	470	280	400	100	20	200	150	550	450	M20	M12	340	140	32	80	35	10
150250 ¹⁾	35	150	200	160	470	280	400	100	20	200	150	500	400	M20	M12	340	140	32	80	35	10
150315	45	150	200	160	530	280	400	100	18	200	150	550	450	M20	M12	370	140	42	110	45	12
150400	45	150	200	160	530	315	450	100	18	200	150	550	450	M20	M12	370	140	42	110	45	12
150500 ¹⁾	55	150	200	180	670	400	500	100	22	200	150	640	540	M20	M16	489	180	50	115	53,5	14

NOLH

DIMENSIONS – POMPE ARBRE NU

Modèle	Palier	Dimensions pompes						Dimensions pattes/support								Bout d'arbre					
		DNA	DNE	a	f	h1	h2	b	c	m1	m2	n1	n2	s1*	s2*	w	x	d1	l	t	u
200250 ¹⁾	45	200	200	160	590	280	400	100	22	200	150	500	400	M20	M12	430	180	42	110	45	12
200315 ¹⁾	55	200	250	200	670	355	450	100	22	200	150	550	450	M20	M16	489	180	50	115	53.5	14
200400 ¹⁾	55	200	250	180	670	355	500	100	22	200	150	550	450	M20	M16	489	180	50	115	53.5	14
200500 ¹⁾	55	200	250	200	670	425	560	100	22	200	150	660	560	M20	M16	489	180	50	115	53.5	14
250300 ¹⁾	55	250	300	305	655	425	550	120	28	240	190	700	600	M20	M16	474	180	50	115	53.5	14
250315 ¹⁾	55	250	300	250	670	375	560	120	28	240	190	620	520	M20	M16	489	180	50	115	53.5	14
250400 ¹⁾	65	250	300	250	720	400	600	120	29	240	190	700	600	M20	M16	508	180	60 ²⁾	145	64	18
250500 ¹⁾	65	250	300	250	720	450	670	120	32	240	190	750	650	M20	M16	503	180	60 ²⁾	145	64	18
300400 ¹⁾	65	300	350	300	720	425	670	120	30	250	190	760	660	M24	M16	508	180	60 ²⁾	145	64	18
300500 ¹⁾	65	300	350	300	720	480	670	140	32	250	190	840	720	M24	M16	508	180	60 ²⁾	145	64	18

1) Taille de pompe Transnorm, non compris dans DIN 24255 / EN 733. Brides percées suivant ANSI 150 sur demande.

2) Pour ces tailles de pompe, tolérances = M6.

* Perçage pour tiges de la dimension indiquée.

DIMENSIONS – BRIDES

DN2/DN1	Raccordement brides suivant DIN 2501 PN 16													DIN 2501 PN 10	
	32	40	50	65	80	100	125	150	200	250	300	350	400	150	200
D	140	150	165	185	200	220	250	285	340	405	460	520	580	285	340
k	100	110	125	145	160	180	210	240	295	355	410	470	525	240	295
d2 x nombre	18x4	18x4	18x4	18x4	18x8	18x8	18x8	22x8	22x12	26x12	26x12	26x16	30x16	22x8	22x8

DIMENSIONS ET LOCALISATION – RACCORDS ACCESSOIRES – PALIER 25, 35, 45

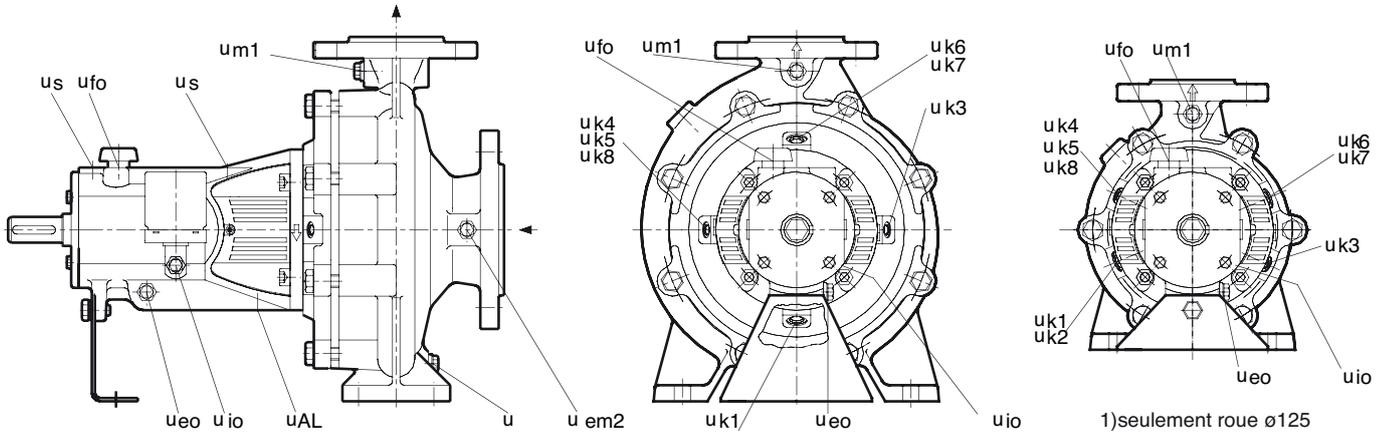

Signification des codes

um1	Mesure de pression (seulement sur demande)
um2	Mesure de pression (seulement sur demande)
ue	Vidange
ueo	Vidange huile
uio	Huileur niveau constant (CLO)
ufo	Remplissage huile
uAL	Récupération gouttes (seulement sur demande)
us	Capteur
uk1	Entrée Quench
uk2	Entrée réchauffage
uk3	051 entrée (Presse-étoupe)
uk4	052 (Balayage externe) –Presse-étoupe
uk5	Flushing externe
uk6	Sortie Quench
uk7	Sortie réchauffage
uk8	051 Sortie (Presse-étoupe)

Dimensions des raccords

Taille	um1	um2	ue	ueo	uio	ufo	uAL	us	uk1	uk2	uk3	uk4	uk5	uk6	uk7	uk8
32125 ¹⁾																
32160																
32200																
32250																
40125 ¹⁾																
40160																
40200			G1/4													
40250																
40315																
50125 ¹⁾																
50160																
50200										G1/8	G1/8	G1/8	G1/8	G1/8	G1/8	G1/8
50250																
50315																
65125 ¹⁾																
65160																
65200																
65250																
65315																
80160	G1/4	G1/4		G1/4	G1/4	15.65	13	M8								
80200																
80250																
80315																
80400										G1/4	G1/4	G1/4	G1/4	G1/4	G1/4	G1/4
100160																
100200																
100250			G3/8							G1/8	G1/8	G1/8	G1/8	G1/8	G1/8	G1/8
100315																
100400										G1/4	G1/4	G1/4	G1/4	G1/4	G1/4	G1/4
125200																
125250																
125315																
125400										G1/4	G1/4	G1/4	G1/4	G1/4	G1/4	G1/4
150200																
150250										G1/8	G1/8	G1/8	G1/8	G1/8	G1/8	G1/8
150315																
150400										G1/4	G1/4	G1/4	G1/4	G1/4	G1/4	G1/4
200250																

NOLH

DIMENSIONS ET LOCALISATION – RACCORDS ACCESSOIRES – PALIER 55, 65

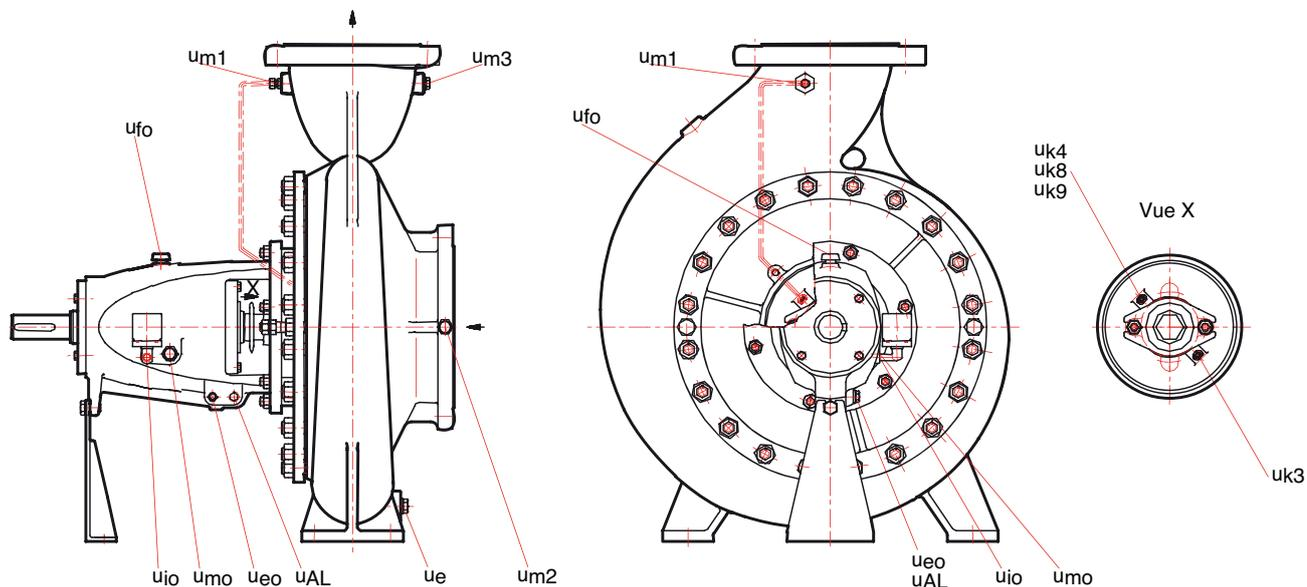

Signification des codes

um1	Liaison Branchée (seulement sur demande)
um2	Mesure pression (seulement sur demande)
um3	Mesure de pression (seulement sur demande)
ue	Vidange
ueo	Vidange huile
uio	Huileur niveau constant
ufo	Remplissage huile
uAL	Récupération des fuites
uk3	051 entrée (presse-étoupe)
uk4	052 arrosage externe (presse-étoupe)
uk8	051 Sortie (presse-étoupe)
uk9	041 entrée (presse-étoupe)
umo	Contrôle niveau d'huile um1

Dimensions des raccords

Taille	um1	um2	ue	ueo	uio	ufo	uAL	um3	uk3	uk4	uk8	umo	uk9
150500													
200315													
200400													
200500													
250300													
250315	G1/4	G1/2	G1/2	G1/4	G1/4	20	G1/2	G1/2	G1/4	G1/4	G1/4	G3/4	G1/4
250400													
250500													
300400													
300500													

DIMENSIONS – GROUPES – 1450 MIN-1 AVEC SPACER

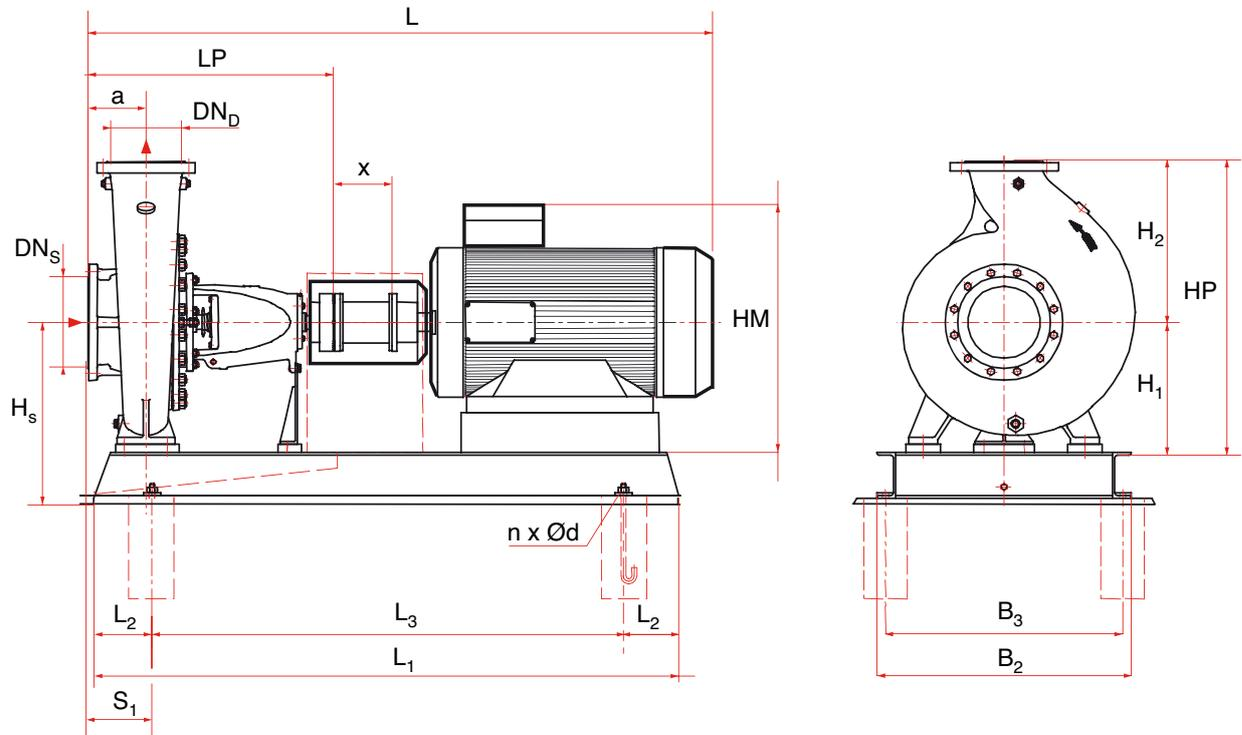

DIMENSIONS – GROUPES – 1450 MIN-1 AVEC SPACER

Type pompe	Type moteur	Puissance nom. moteur (P _{2n} en kW)	Vitesse	châssis	Accouplement	DN _D	DN _S	a	LP	L ₁ *	L ₂ *	L ₃ *	L*	S ₁	x	HM	H _s *	HP	H ₁	H ₂	B ₂ *	B ₃ *	Ø d*	n*	Poids groupe
NOLH 032-125	71	0,37	1450	800 x 270 F	H80	32	50	80	440	840	150	540	788	160	100	139	112	335	112	140	360	320	19	4	89
NOLH 032-160	71	0,37	1450	800 x 270 F	H80	32	50	80	440	840	150	540	788	160	100	139	132	375	132	160	360	320	19	4	91
NOLH 032-160	80	0,55	1450	800 x 270 F	H80	32	50	80	440	840	150	540	816	160	100	210	132	375	132	160	360	320	19	4	94
NOLH 032-160	80	0,75	1450	800 x 270 F	H80	32	50	80	440	840	150	540	816	160	100	210	132	375	132	160	360	320	19	4	96
NOLH 032-200	80	0,55	1450	800 x 270 F	H80	32	50	80	440	840	150	540	816	160	100	210	160	423	160	180	360	320	19	4	95
NOLH 032-200	80	0,75	1450	800 x 270 F	H80	32	50	80	440	840	150	540	816	160	100	210	160	423	160	180	360	320	19	4	97
NOLH 032-200	90S	1,1	1450	800 x 270 F	H80	32	50	80	440	840	150	540	844	160	100	240	160	423	160	180	360	320	19	4	101
NOLH 032-200	90L	1,5	1450	800 x 270 F	H80	32	50	80	440	840	150	540	869	160	100	240	160	423	160	180	360	320	19	4	105
NOLH 032-250	80	0,75	1450	1000 x 340 F	H80	32	50	100	460	1040	190	660	836	207,5	100	210	180	508	180	225	450	400	24	4	132
NOLH 032-250	90S	1,1	1450	1000 x 340 F	H80	32	50	100	460	1040	190	660	864	207,5	100	240	180	508	180	225	450	400	24	4	137
NOLH 032-250	90L	1,5	1450	1000 x 340 F	H80	32	50	100	460	1040	190	660	889	207,5	100	240	180	508	180	225	450	400	24	4	141
NOLH 032-250	100L	2,2	1450	1000 x 340 F	H80	32	50	100	460	1040	190	660	936	207,5	100	260	180	508	180	225	450	400	24	4	149

* = C tes données titre indicatif, ne pas utiliser ces valeurs pour réalisation.

NOLH

DIMENSIONS – GROUPES – 1450 MIN-1 AVEC SPACER

Type pompe	Type moteur	Puissance nom. moteur (P2n en kW)	Vitesse	châssis	Accouplement	DND	DNS	a	LP	L1*	L2*	L3*	L*	S1	x	HM	Hs*	HP	H1	H2	B2*	B3*	Ø d*	n*	Poids groupe
NOLH 040-125	71	0,37	1450	800 x 270 F	H80	40	65	80	440	840	150	540	788	160	100	139	112	335	112	140	360	320	19	4	86
NOLH 040-125	80	0,55	1450	800 x 270 F	H80	40	65	80	440	840	150	540	816	160	100	210	112	335	112	140	360	320	19	4	89
NOLH 040-160	71	0,37	1450	800 x 270 F	H80	40	65	80	440	840	150	540	788	160	100	139	132	375	132	160	360	320	19	4	88
NOLH 040-160	80	0,55	1450	800 x 270 F	H80	40	65	80	440	840	150	540	816	160	100	210	132	375	132	160	360	320	19	4	91
NOLH 040-160	80	0,75	1450	800 x 270 F	H80	40	65	80	440	840	150	540	816	160	100	210	132	375	132	160	360	320	19	4	93
NOLH 040-160	90S	1,1	1450	800 x 270 F	H80	40	65	80	440	840	150	540	844	160	100	240	132	375	132	160	360	320	19	4	97
NOLH 040-160	90L	1,5	1450	800 x 270 F	H80	40	65	80	440	840	150	540	869	160	100	240	132	375	132	160	360	320	19	4	101
NOLH 040-200	80	0,55	1450	800 x 270 F	H80	40	65	100	460	840	150	540	836	180	100	210	160	423	160	180	360	320	19	4	97
NOLH 040-200	80	0,75	1450	800 x 270 F	H80	40	65	100	460	840	150	540	836	180	100	210	160	423	160	180	360	320	19	4	99
NOLH 040-200	90S	1,1	1450	800 x 270 F	H80	40	65	100	460	840	150	540	864	180	100	240	160	423	160	180	360	320	19	4	103
NOLH 040-200	90L	1,5	1450	800 x 270 F	H80	40	65	100	460	840	150	540	889	180	100	240	160	423	160	180	360	320	19	4	107
NOLH 040-200	100L	2,2	1450	900 x 300 F	H80	40	65	100	460	940	170	600	936	200	100	260	160	423	160	180	390	350	19	4	126
NOLH 040-250	90S	1,1	1450	1000 x 340 F	H80	40	65	100	460	1040	190	660	864	207,5	100	240	180	508	180	225	450	400	24	4	137
NOLH 040-250	90L	1,5	1450	1000 x 340 F	H80	40	65	100	460	1040	190	660	889	207,5	100	240	180	508	180	225	450	400	24	4	141
NOLH 040-250	100L	2,2	1450	1000 x 340 F	H80	40	65	100	460	1040	190	660	936	207,5	100	260	180	508	180	225	450	400	24	4	149
NOLH 040-250	100L	3	1450	1000 x 340 F	H80	40	65	100	460	1040	190	660	936	207,5	100	260	180	508	180	225	450	400	24	4	152
NOLH 040-315	100L	2,2	1450	1120 x 380 F	H80	40	65	125	595	1160	210	740	1071	252,5	100	260	225	578	225	250	490	440	24	4	212
NOLH 040-315	100L	3	1450	1120 x 380 F	H80	40	65	125	595	1160	210	740	1071	252,5	100	260	225	578	225	250	490	440	24	4	215
NOLH 040-315	112M	4	1450	1120 x 380 F	H80	40	65	125	595	1160	210	740	1088	252,5	100	292	225	578	225	250	490	440	24	4	228
NOLH 040-315	132S	5,5	1450	1120 x 380 F	H95	40	65	125	595	1160	210	740	1147	252,5	100	339	225	578	225	250	490	440	24	4	244
NOLH 050-125	71	0,37	1450	800 x 270 F	H80	50	65	100	460	840	150	540	808	180	100	139	132	375	132	160	360	320	19	4	88
NOLH 050-125	80	0,55	1450	800 x 270 F	H80	50	65	100	460	840	150	540	836	180	100	210	132	375	132	160	360	320	19	4	91
NOLH 050-125	80	0,75	1450	800 x 270 F	H80	50	65	100	460	840	150	540	836	180	100	210	132	375	132	160	360	320	19	4	93
NOLH 050-160	80	0,55	1450	800 x 270 F	H80	50	65	100	460	840	150	540	836	180	100	210	160	423	160	180	360	320	19	4	97
NOLH 050-160	80	0,75	1450	800 x 270 F	H80	50	65	100	460	840	150	540	836	180	100	210	160	423	160	180	360	320	19	4	99
NOLH 050-160	90S	1,1	1450	800 x 270 F	H80	50	65	100	460	840	150	540	864	180	100	240	160	423	160	180	360	320	19	4	103
NOLH 050-160	90L	1,5	1450	800 x 270 F	H80	50	65	100	460	840	150	540	889	180	100	240	160	423	160	180	360	320	19	4	107
NOLH 050-200	80	0,75	1450	800 x 270 F	H80	50	65	100	460	840	150	540	836	180	100	210	160	443	160	200	360	320	19	4	103
NOLH 050-200	90S	1,1	1450	800 x 270 F	H80	50	65	100	460	840	150	540	864	180	100	240	160	443	160	200	360	320	19	4	107
NOLH 050-200	90L	1,5	1450	800 x 270 F	H80	50	65	100	460	840	150	540	889	180	100	240	160	443	160	200	360	320	19	4	111
NOLH 050-200	100L	2,2	1450	900 x 300 F	H80	50	65	100	460	940	170	600	936	200	100	260	160	443	160	200	390	350	19	4	130
NOLH 050-200	100L	3	1450	900 x 300 F	H80	50	65	100	460	940	170	600	936	200	100	260	160	443	160	200	390	350	19	4	133
NOLH 050-250	90L	1,5	1450	1000 x 340 F	H80	50	65	100	460	1040	190	660	889	207,5	100	240	180	508	180	225	450	400	24	4	145
NOLH 050-250	100L	2,2	1450	1000 x 340 F	H80	50	65	100	460	1040	190	660	936	207,5	100	260	180	508	180	225	450	400	24	4	153
NOLH 050-250	100L	3	1450	1000 x 340 F	H80	50	65	100	460	1040	190	660	936	207,5	100	260	180	508	180	225	450	400	24	4	156
NOLH 050-250	112M	4	1450	1000 x 340 F	H80	50	65	100	460	1040	190	660	953	207,5	100	292	180	508	180	225	450	400	24	4	169
NOLH 050-315	112M	4	1450	1120 x 380 F	H95	50	65	125	595	1160	210	740	1088	252,5	100	292	225	608	225	280	490	440	24	4	245
NOLH 050-315	132S	5,5	1450	1120 x 380 F	H95	50	65	125	595	1160	210	740	1147	252,5	100	339	225	608	225	280	490	440	24	4	259
NOLH 050-315	132M	7,5	1450	1120 x 380 F	H80	50	65	125	595	1160	210	740	1185	252,5	100	339	225	608	225	280	490	440	24	4	267
NOLH 050-315	132M	9	1450	1120 x 380 F	H80	50	65	125	595	1160	210	740	1185	252,5	100	339	225	608	225	280	490	440	24	4	272
NOLH 065-125	80	0,55	1450	900 x 300 F	H80	65	80	100	460	940	170	600	836	187,5	100	210	160	423	160	180	390	350	19	4	105
NOLH 065-125	80	0,75	1450	900 x 300 F	H80	65	80	100	460	940	170	600	836	187,5	100	210	160	423	160	180	390	350	19	4	106
NOLH 065-125	90S	1,1	1450	900 x 300 F	H80	65	80	100	460	940	170	600	864	187,5	100	240	160	423	160	180	390	350	19	4	111

* = C tes donnÉes ^ titre indicatif, ne pas utiliser ces valeurs pour rÉalisation.

DIMENSIONS – GROUPES – 1450 MIN-1 AVEC SPACER

Type pompe	Type moteur	Puissance nom. moteur (P2h en kW)	Vitesse	châssis	Accouplement	DND	DNS	a	LP	L1*	L2*	L3*	L*	S1	x	HM	Hs*	HP	H1	H2	B2*	B3*	Ø d*	r*	Poids groupe
NOLH 065-160	80	0,75	1450	900 x 300 F	H80	65	80	100	460	940	170	600	836	187,5	100	210	160	443	160	200	390	350	19	4	113
NOLH 065-160	90L	1,5	1450	900 x 300 F	H80	65	80	100	460	940	170	600	889	187,5	100	240	160	443	160	200	390	350	19	4	121
NOLH 065-160	100L	2,2	1450	900 x 300 F	H80	65	80	100	460	940	170	600	936	187,5	100	260	160	443	160	200	390	350	19	4	129
NOLH 065-200	90S	1,1	1450	1000 x 340 F	H80	65	80	100	460	1040	190	660	904	207,5	140	240	180	508	180	225	450	400	24	4	136
NOLH 065-200	90L	1,5	1450	1000 x 340 F	H80	65	80	100	460	1040	190	660	929	207,5	140	240	180	508	180	225	450	400	24	4	139
NOLH 065-200	100L	2,2	1450	1000 x 340 F	H80	65	80	100	460	1040	190	660	976	207,5	140	260	180	508	180	225	450	400	24	4	148
NOLH 065-200	100L	3	1450	1000 x 340 F	H80	65	80	100	460	1040	190	660	976	207,5	140	260	180	508	180	225	450	400	24	4	151
NOLH 065-200	112M	4	1450	1000 x 340 F	H80	65	80	100	460	1040	190	660	993	207,5	140	292	180	508	180	225	450	400	24	4	164
NOLH 065-250	100L	2,2	1450	1120 x 380 F	H80	65	80	100	570	1160	210	740	1086	210	140	260	200	553	200	250	490	440	24	4	209
NOLH 065-250	100L	3	1450	1120 x 380 F	H80	65	80	100	570	1160	210	740	1086	210	140	260	200	553	200	250	490	440	24	4	212
NOLH 065-250	112M	4	1450	1120 x 380 F	H80	65	80	100	570	1160	210	740	1103	210	140	292	200	553	200	250	490	440	24	4	225
NOLH 065-250	132S	5,5	1450	1120 x 380 F	H95	65	80	100	570	1160	210	740	1162	210	140	339	200	553	200	250	490	440	24	4	241
NOLH 065-315	132M	9	1450	1250 x 430 F	H95	65	80	125	595	1310	235	840	1225	260	140	339	225	608	225	280	540	490	24	4	309
NOLH 065-315	160M	11	1450	1250 x 430 F	H95	65	80	125	595	1310	235	840	1333	260	140	410	225	608	225	280	540	490	24	4	343
NOLH 065-315	160L	15	1450	1250 x 430 F	H110	65	80	125	595	1310	235	840	1377	260	140	410	225	608	225	280	540	490	24	4	361
NOLH 065-315	132S	5,5	1450	1250 x 430 F	H95	65	80	125	595	1310	235	840	1187	260	140	339	225	608	225	280	540	490	24	4	295
NOLH 065-315	132M	7,5	1450	1250 x 430 F	H95	65	80	125	595	1310	235	840	1225	260	140	339	225	608	225	280	540	490	24	4	304
NOLH 080-160	80	0,75	1450	1000 x 340 F	H80	80	100	125	485	1040	190	660	901	232,5	140	210	180	508	180	225	450	400	24	4	129
NOLH 080-160	90S	1,1	1450	1000 x 340 F	H80	80	100	125	485	1040	190	660	929	232,5	140	240	180	508	180	225	450	400	24	4	134
NOLH 080-160	90L	1,5	1450	1000 x 340 F	H80	80	100	125	485	1040	190	660	954	232,5	140	240	180	508	180	225	450	400	24	4	137
NOLH 080-160	100L	2,2	1450	1000 x 340 F	H80	80	100	125	485	1040	190	660	1001	232,5	140	260	180	508	180	225	450	400	24	4	146
NOLH 080-160	100L	3	1450	1000 x 340 F	H80	80	100	125	485	1040	190	660	1001	232,5	140	260	180	508	180	225	450	400	24	4	149
NOLH 080-160	112M	4	1450	1000 x 340 F	H80	80	100	125	485	1040	190	660	1018	232,5	140	292	180	508	180	225	450	400	24	4	162
NOLH 080-200	90L	1,5	1450	1120 x 380 F	H80	80	100	125	595	1160	210	740	1064	309	140	240	180	533	180	250	490	440	24	4	190
NOLH 080-200	100L	2,2	1450	1120 x 380 F	H80	80	100	125	595	1160	210	740	1111	309	140	260	180	533	180	250	490	440	24	4	198
NOLH 080-200	100L	3	1450	1120 x 380 F	H80	80	100	125	595	1160	210	740	1111	309	140	260	180	533	180	250	490	440	24	4	201
NOLH 080-200	112M	4	1450	1120 x 380 F	H80	80	100	125	595	1160	210	740	1128	309	140	292	180	533	180	250	490	440	24	4	214
NOLH 080-200	132S	5,5	1450	1120 x 380 F	H95	80	100	125	595	1160	210	740	1187	309	140	339	180	533	180	250	490	440	24	4	230
NOLH 080-250	100L	3	1450	1250 x 430 F	H80	80	100	125	595	1310	235	840	1111	260	140	260	200	583	200	280	540	490	24	4	249
NOLH 080-250	112M	4	1450	1250 x 430 F	H80	80	100	125	595	1310	235	840	1128	260	140	292	200	583	200	280	540	490	24	4	261
NOLH 080-250	132S	5,5	1450	1250 x 430 F	H95	80	100	125	595	1310	235	840	1187	260	140	339	200	583	200	280	540	490	24	4	277
NOLH 080-250	132M	7,5	1450	1250 x 430 F	H95	80	100	125	595	1310	235	840	1225	260	140	339	200	583	200	280	540	490	24	4	286
NOLH 080-315	132S	5,5	1450	1250 x 430 F	H95	80	100	125	595	1310	235	840	1187	260	140	339	250	668	250	315	540	490	24	4	298
NOLH 080-315	132M	7,5	1450	1250 x 430 F	H95	80	100	125	595	1310	235	840	1225	260	140	339	250	668	250	315	540	490	24	4	307
NOLH 080-315	132M	9	1450	1250 x 430 F	H95	80	100	125	595	1310	235	840	1225	260	140	339	250	668	250	315	540	490	24	4	312
NOLH 080-315	160M	11	1450	1250 x 430 F	H95	80	100	125	595	1310	235	840	1333	260	140	410	250	668	250	315	540	490	24	4	346
NOLH 080-315	160L	15	1450	1250 x 430 F	H110	80	100	125	595	1310	235	840	1377	260	140	410	250	668	250	315	540	490	24	4	365
NOLH 080-400	160M	11	1450	1400 x 480 F	H95	80	125	125	655	1460	260	940	1393	285	140	410	280	738	280	355	610	550	29	4	443
NOLH 080-400	160L	15	1450	1400 x 480 F	H95	80	125	125	655	1460	260	940	1437	285	140	410	280	738	280	355	610	550	29	4	460
NOLH 080-400	180M	18,5	1450	1400 x 480 F	H110	80	125	125	655	1460	260	940	1459	285	140	450	280	738	280	355	610	550	29	4	503
NOLH 080-400	180L	22	1450	1400 x 480 F	H110	80	125	125	655	1460	260	940	1497	285	140	450	280	738	280	355	610	550	29	4	527
NOLH 080-400	200L	30	1450	1400 x 480 F	H125	80	125	125	655	1460	260	940	1562	285	140	494	280	738	280	355	610	550	29	4	582
NOLH 100-160	100L	2,2	1450	1120 x 380 F	H80	100	125	125	595	1160	210	740	1111	235	140	260	200	583	200	280	490	440	24	4	217

* = C tes données ^ titre indicatif, ne pas utiliser ces valeurs pour ralisation.

NOLH

DIMENSIONS – GROUPES – 1450 MIN-1 AVEC SPACER

Type pompe	Type moteur	Puissance nom. moteur (P2n en kW)	Vitesse	châssis	Accouplement	DND	DNS	a	LP	L1*	L2*	L3*	L*	S1	x	HM	Hs*	HP	H1	H2	B2*	B3*	Ø dt*	n*	Poids groupe
NOLH 100-160	100L	3	1450	1120 x 380 F	H80	100	125	125	595	1160	210	740	1111	235	140	260	200	583	200	280	490	440	24	4	220
NOLH 100-160	112M	4	1450	1120 x 380 F	H80	100	125	125	595	1160	210	740	1128	235	140	292	200	583	200	280	490	440	24	4	233
NOLH 100-160	132S	5,5	1450	1120 x 380 F	H95	100	125	125	595	1160	210	740	1187	235	140	339	200	583	200	280	490	440	24	4	249
NOLH 100-200	100L	2,2	1450	1120 x 380 F	H80	100	125	125	595	1160	210	740	1111	235	140	260	200	583	200	280	490	440	24	4	209
NOLH 100-200	100L	3	1450	1120 x 380 F	H80	100	125	125	595	1160	210	740	1111	235	140	260	200	583	200	280	490	440	24	4	212
NOLH 100-200	112M	4	1450	1120 x 380 F	H80	100	125	125	595	1160	210	740	1128	235	140	292	200	583	200	280	490	440	24	4	225
NOLH 100-200	132S	5,5	1450	1120 x 380 F	H95	100	125	125	595	1160	210	740	1187	235	140	339	200	583	200	280	490	440	24	4	241
NOLH 100-200	132M	7,5	1450	1250 x 430 F	H95	100	125	125	595	1310	235	840	1225	260	140	339	200	583	200	280	540	490	24	4	281
NOLH 100-250	112M	4	1450	1250 x 430 F	H80	100	125	140	610	1310	235	840	1143	275	140	292	225	608	225	280	540	490	24	4	272
NOLH 100-250	132S	5,5	1450	1250 x 430 F	H95	100	125	140	610	1310	235	840	1202	275	140	339	225	608	225	280	540	490	24	4	288
NOLH 100-250	132M	7,5	1450	1250 x 430 F	H95	100	125	140	610	1310	235	840	1240	275	140	339	225	608	225	280	540	490	24	4	296
NOLH 100-250	132M	9	1450	1250 x 430 F	H95	100	125	140	610	1310	235	840	1240	275	140	339	225	608	225	280	540	490	24	4	302
NOLH 100-250	160M	11	1450	1250 x 430 F	H95	100	125	140	610	1310	235	840	1348	275	140	410	225	608	225	280	540	490	24	4	335
NOLH 100-315	160M	11	1450	1250 x 430 F	H95	100	125	140	610	1310	235	840	1348	275	140	410	250	668	250	315	540	490	24	4	355
NOLH 100-315	160L	15	1450	1400 x 480 F	H110	100	125	140	610	1460	260	940	1392	300	140	410	250	668	250	315	610	550	29	4	421
NOLH 100-315	180M	18,5	1450	1250 x 430 F	H110	100	125	140	610	1310	235	840	1414	275	140	450	250	668	250	315	540	490	24	4	415
NOLH 100-315	180L	22	1450	1400 x 480 F	H125	100	125	140	610	1460	260	940	1452	300	140	450	250	668	250	315	610	550	29	4	489
NOLH 100-400	160L	15	1450	1600 x 530 F	H95	100	125	140	670	1660	300	1060	1452	320	140	410	280	758	280	355	660	600	29	4	537
NOLH 100-400	180M	18,5	1450	1600 x 530 F	H110	100	125	140	670	1660	300	1060	1474	320	140	450	280	758	280	355	660	600	29	4	580
NOLH 100-400	180L	22	1450	1600 x 530 F	H110	100	125	140	670	1660	300	1060	1512	320	140	450	280	758	280	355	660	600	29	4	604
NOLH 100-400	200L	30	1450	1600 x 530 F	H125	100	125	140	670	1660	300	1060	1577	320	140	494	280	758	280	355	660	600	29	4	659
NOLH 100-400	225S-M	37	1450	1600 x 530 F	H140	100	125	140	670	1660	300	1060	1657	320	140	593	280	758	280	355	660	600	29	4	785
NOLH 100-400	225S-M	45	1450	1600 x 530 F	H140	100	125	140	670	1660	300	1060	1657	320	140	593	280	758	280	355	660	600	29	4	819
NOLH 125-200	132M	7,5	1450	1250 x 430 F	H95	125	150	140	610	1310	235	840	1240	275	140	339	250	668	250	315	540	490	24	4	312
NOLH 125-200	132M	9	1450	1250 x 430 F	H95	125	150	140	610	1310	235	840	1240	275	140	339	250	668	250	315	540	490	24	4	317
NOLH 125-200	160M	11	1450	1250 x 430 F	H95	125	150	140	610	1310	235	840	1348	275	140	410	250	668	250	315	540	490	24	4	351
NOLH 125-200	160L	15	1450	1400 x 480 F	H110	125	150	140	610	1460	260	940	1392	300	140	410	250	668	250	315	610	550	29	4	417
NOLH 125-250	132M	7,5	1450	1250 x 430 F	H95	125	150	140	610	1310	235	840	1240	275	140	339	250	708	250	355	540	490	24	4	314
NOLH 125-250	132M	9	1450	1250 x 430 F	H95	125	150	140	610	1310	235	840	1240	275	140	339	250	708	250	355	540	490	24	4	319
NOLH 125-250	160M	11	1450	1250 x 430 F	H95	125	150	140	610	1310	235	840	1348	275	140	410	250	708	250	355	540	490	24	4	353
NOLH 125-250	160L	15	1450	1400 x 480 F	H110	125	150	140	610	1460	260	940	1392	300	140	410	250	708	250	355	610	550	29	4	419
NOLH 125-250	180M	18,5	1450	1400 x 480 F	H110	125	150	140	610	1460	260	940	1414	300	140	450	250	708	250	355	610	550	29	4	460
NOLH 125-315	160L	15	1450	1600 x 530 F	H95	125	150	140	670	1660	300	1060	1452	320	140	410	280	758	280	355	660	600	29	4	510
NOLH 125-315	180M	18,5	1450	1600 x 530 F	H110	125	150	140	670	1660	300	1060	1474	320	140	450	280	758	280	355	660	600	29	4	553
NOLH 125-315	180L	22	1450	1600 x 530 F	H110	125	150	140	670	1660	300	1060	1512	320	140	450	280	758	280	355	660	600	29	4	577
NOLH 125-315	200L	30	1450	1600 x 530 F	H125	125	150	140	670	1660	300	1060	1577	320	140	494	280	758	280	355	660	600	29	4	632
NOLH 125-315	225S-M	37	1450	1600 x 530 F	H140	125	150	140	670	1660	300	1060	1657	320	140	593	280	758	280	355	660	600	29	4	758
NOLH 125-400	200L	30	1450	1600 x 530 F	H125	125	150	140	670	1660	300	1060	1577	320	140	494	315	838	315	400	660	600	29	4	671
NOLH 125-400	225S-M	37	1450	1600 x 530 F	H140	125	150	140	670	1660	300	1060	1657	320	140	593	315	838	315	400	660	600	29	4	797
NOLH 125-400	225S-M	45	1450	1600 x 530 F	H140	125	150	140	670	1660	300	1060	1657	320	140	593	315	838	315	400	660	600	29	4	830
NOLH 125-400	250S-M	55	1450	1600 x 530 F	H160	125	150	140	670	1660	300	1060	1733	320	140	618	315	838	315	400	660	600	29	4	916
NOLH 125-400	280S-M	75	1450	1600 x 530 F	H180	125	150	140	670	1660	300	1060	1846	320	140	743	315	838	315	400	660	600	29	4	1211
NOLH 150-200	132M	7,5	1450	1800 x 600 F	H95	150	200	160	630	1860	330	1200	1260	370	140	339	280	803	280	400	730	670	29	4	520

* = C tes données ^ titre indicatif, ne pas utiliser ces valeurs pour réalisation.

DIMENSIONS – GROUPES – 1450 MIN-1 AVEC SPACER

Type pompe	Type moteur	Puissance nom. moteur (P2h en kW)	Vitesse	châssis	Accouplement	DND	DNS	a	LP	L1*	L2*	L3*	L*	S1	x	HM	Hs*	HP	H1	H2	B2*	B3*	Ø d*	r*	Poids groupe
NOLH 150-200	132M	9	1450	1800 x 600 F	H95	150	200	160	630	1860	330	1200	1260	370	140	339	280	803	280	400	730	670	29	4	525
NOLH 150-200	160M	11	1450	1800 x 600 F	H95	150	200	160	630	1860	330	1200	1368	370	140	410	280	803	280	400	730	670	29	4	559
NOLH 150-200	160L	15	1450	1800 x 600 F	H110	150	200	160	630	1860	330	1200	1412	370	140	410	280	803	280	400	730	670	29	4	578
NOLH 150-200	180M	18,5	1450	1800 x 600 F	H110	150	200	160	630	1860	330	1200	1434	370	140	450	280	803	280	400	730	670	29	4	619
NOLH 150-250	160L	15	1450	1600 x 530 F	H110	150	200	160	630	1660	300	1060	1412	340	140	410	280	803	280	400	660	600	29	4	487
NOLH 150-250	180M	18,5	1450	1600 x 530 F	H110	150	200	160	630	1660	300	1060	1434	340	140	450	280	803	280	400	660	600	29	4	528
NOLH 150-250	180L	22	1450	1600 x 530 F	H125	150	200	160	630	1660	300	1060	1472	340	140	450	280	803	280	400	660	600	29	4	555
NOLH 150-250	200L	30	1450	1600 x 530 F	H140	150	200	160	630	1660	300	1060	1537	340	140	494	280	803	280	400	660	600	29	4	611
NOLH 150-315	180L	22	1450	1800 x 600 F	H110	150	200	160	690	1860	330	1200	1532	370	140	450	280	803	280	400	730	670	29	4	692
NOLH 150-315	200L	30	1450	1800 x 600 F	H125	150	200	160	690	1860	330	1200	1597	370	140	494	280	803	280	400	730	670	29	4	747
NOLH 150-315	225S-M	37	1450	1800 x 600 F	H140	150	200	160	690	1860	330	1200	1677	370	140	593	280	803	280	400	730	670	29	4	873
NOLH 150-315	225S-M	45	1450	1800 x 600 F	H140	150	200	160	690	1860	330	1200	1677	370	140	593	280	803	280	400	730	670	29	4	907
NOLH 150-315	250S-M	55	1450	1800 x 600 F	H160	150	200	160	690	1860	330	1200	1753	370	140	618	280	803	280	400	730	670	29	4	993
NOLH 150-400	225S-M	45	1450	1800 x 600 F	H140	150	200	160	690	1860	330	1200	1677	370	140	593	315	888	315	450	730	670	29	4	944
NOLH 150-400	250S-M	55	1450	1800 x 600 F	H160	150	200	160	690	1860	330	1200	1753	370	140	618	315	888	315	450	730	670	29	4	1029
NOLH 150-400	280S-M	75	1450	1800 x 600 F	H180	150	200	160	690	1860	330	1200	1866	370	140	743	315	888	315	450	730	670	29	4	1324
NOLH 150-400	280S-M	90	1450	1800 x 600 F	H180	150	200	160	690	1860	330	1200	1866	370	140	743	315	888	315	450	730	670	29	4	1394
NOLH 150-500	315S-M	110	1450	2100x740 F	H200	150	200	180	850	2140	370	1400	2186	430	180	930	523	1023	400	500	860	790	29	4	1628
NOLH 150-500	315S-M	132	1450	2100x740 F	H200	150	200	180	850	2140	370	1400	2186	430	180	930	523	1023	400	500	860	790	29	4	1777
NOLH 150-500	315S-M	160	1450	2100x740 F	H200	150	200	180	850	2140	370	1400	2186	430	180	930	523	1023	400	500	860	790	29	4	1777
NOLH 150-500	315B	200	1450	2500x700	H200	150	200	180	850	2500	250	1000	2600	255	180	1135	630	1130	400	500	850	790	28	6	1976
NOLH 150-500	355M-L	250	1450	2500x800	H225	150	200	180	850	2500	250	1000	2496	255	180	1265	630	1130	400	500	950	890	28	6	2383
NOLH 150-500	180L	22	1450	1600x700	H125	150	200	180	850	1600	270	1060	1732	295	180	590	540	1040	400	500	810	790	20	4	688
NOLH 150-500	200L	30	1450	1800x700	H125	150	200	180	850	1800	300	1200	1797	315	180	674	580	1080	400	500	830	790	25	4	785
NOLH 150-500	225S-M	37	1450	1800x700	H140	150	200	180	850	1800	300	1200	1877	315	180	773	580	1080	400	500	830	790	25	4	908
NOLH 150-500	225S-M	45	1450	1800x700	H140	150	200	180	850	1800	300	1200	1877	315	180	773	580	1080	400	500	830	790	25	4	941
NOLH 150-500	250S-M	55	1450	1800x700	H160	150	200	180	850	1800	300	1200	1953	315	180	798	580	1080	400	500	830	790	25	4	1025
NOLH 150-500	280S-M	75	1450	2000x700	H180	150	200	180	850	2000	350	1300	2066	365	180	933	590	1090	400	500	830	790	25	4	1338
NOLH 150-500	280S-M	90	1450	2000x700	H180	150	200	180	850	2000	350	1300	2066	365	180	933	590	1090	400	500	830	790	25	4	1407
NOLH 200-250	160L	15	1450	1600x530 F	H110	200	200	160	750	1660	300	1060	1572	330	180	533	403	803	280	400	660	600	29	4	583
NOLH 200-250	180M	18,5	1450	1600x530 F	H110	200	200	160	750	1660	300	1060	1594	330	180	573	403	803	280	400	660	600	29	4	623
NOLH 200-250	180L	22	1450	1600x530 F	H110	200	200	160	750	1660	300	1060	1632	330	180	573	403	803	280	400	660	600	29	4	647
NOLH 200-250	200L	30	1450	1600x530 F	H125	200	200	160	750	1660	300	1060	1697	330	180	617	403	803	280	400	660	600	29	4	701
NOLH 200-315	180L	22	1450	1800x600 F	H125	200	250	200	870	1860	330	1200	1752	400	180	573	478	928	355	450	730	670	29	4	826
NOLH 200-315	200L	30	1450	1800x600 F	H125	200	250	200	870	1860	330	1200	1817	400	180	617	478	928	355	450	730	670	29	4	877
NOLH 200-315	225S-M	37	1450	1800x600 F	H140	200	250	200	870	1860	330	1200	1897	400	180	716	478	928	355	450	730	670	29	4	1001
NOLH 200-315	225S-M	45	1450	1800x600 F	H140	200	250	200	870	1860	330	1200	1897	400	180	716	478	928	355	450	730	670	29	4	1034
NOLH 200-315	250S-M	55	1450	1800x600 F	H160	200	250	200	870	1860	330	1200	1973	400	180	741	478	928	355	450	730	670	29	4	1118
NOLH 200-315	280S-M	75	1450	1800x600 F	H180	200	250	200	870	1860	330	1200	2086	400	180	866	478	928	355	450	730	670	29	4	1407
NOLH 200-400	315S-M	110	1450	2100x740 F	H200	200	250	180	850	2140	370	1400	2186	430	180	930	478	978	355	500	860	790	29	4	1633
NOLH 200-400	315S-M	132	1450	2100x740 F	H200	200	250	180	850	2140	370	1400	2186	430	180	930	478	978	355	500	860	790	29	4	1782
NOLH 200-400	315S-M	160	1450	2100x740 F	H200	200	250	180	850	2140	370	1400	2186	430	180	930	478	978	355	500	860	790	29	4	1782
NOLH 200-400	315B	200	1450	2500x700	H200	200	250	180	850	2500	250	1000	2600	255	180	1135	585	1085	355	500	850	790	28	6	1981

* = C tes données ^ titre indicatif, ne pas utiliser ces valeurs pour ralisation.

NOLH

DIMENSIONS – GROUPES – 1450 MIN-1 AVEC SPACER

Type pompe	Type moteur	Puissance nom. moteur (P2n en kW)	Vitesse	châssis	Accouplement	DND	DNS	a	LP	L1*	L2*	L3*	L*	S1	x	HM	Hs*	HP	H1	H2	B2*	B3*	Ø d*	n*	Poids groupe
NOLH 200-400	355M-L	250	1450	2500x800	H225	200	250	180	850	2500	250	1000	2496	255	180	1265	585	1085	355	500	950	890	28	6	2389
NOLH 200-400	180L	22	1450	1800x600 F	H125	200	250	180	850	1860	330	1200	1732	380	180	573	478	978	355	500	730	670	29	4	857
NOLH 200-400	200L	30	1450	1800x600 F	H125	200	250	180	850	1860	330	1200	1797	380	180	617	478	978	355	500	730	670	29	4	908
NOLH 200-400	225S-M	37	1450	1800x600 F	H140	200	250	180	850	1860	330	1200	1877	380	180	716	478	978	355	500	730	670	29	4	1032
NOLH 200-400	225S-M	45	1450	1800x600 F	H140	200	250	180	850	1860	330	1200	1877	380	180	716	478	978	355	500	730	670	29	4	1065
NOLH 200-400	250S-M	55	1450	1800x600 F	H160	200	250	180	850	1860	330	1200	1953	380	180	741	478	978	355	500	730	670	29	4	1149
NOLH 200-400	280S-M	75	1450	1800x600 F	H180	200	250	180	850	1860	330	1200	2066	380	180	866	478	978	355	500	730	670	29	4	1438
NOLH 200-400	280S-M	90	1450	1800x600 F	H180	200	250	180	850	1860	330	1200	2066	380	180	866	478	978	355	500	730	670	29	4	1507
NOLH 200-500	315S-M	110	1450	2100x740 F	H200	200	250	200	870	2140	370	1400	2206	450	180	930	548	1108	425	560	860	790	29	4	1690
NOLH 200-500	315S-M	132	1450	2100x740 F	H200	200	250	200	870	2140	370	1400	2206	450	180	930	548	1108	425	560	860	790	29	4	1839
NOLH 200-500	315S-M	160	1450	2100x740 F	H200	200	250	200	870	2140	370	1400	2206	450	180	930	548	1108	425	560	860	790	29	4	1839
NOLH 200-500	315B	200	1450	2500x700	H200	200	250	200	870	2500	250	1000	2620	275	180	1135	655	1215	425	560	850	790	28	6	2038
NOLH 200-500	355M-L	250	1450	2500x800	H225	200	250	200	870	2500	250	1000	2516	275	180	1265	655	1215	425	560	950	890	28	6	2445
NOLH 200-500	355M-L	315	1450	2500x800	H250	200	250	200	870	2500	250	1000	2516	275	180	1265	655	1215	425	560	950	890	28	6	2661
NOLH 200-500	355L	355	1450	2500x800	H250	200	250	200	870	2500	250	1000	2659	275	180	1165	655	1215	425	560	950	890	28	6	2702
NOLH 200-500	225S-M	45	1450	1800x700	H140	200	250	200	870	1800	300	1200	1897	335	180	773	605	1165	425	560	830	790	25	4	1003
NOLH 200-500	250S-M	55	1450	1800x700	H160	200	250	200	870	1800	300	1200	1973	335	180	798	605	1165	425	560	830	790	25	4	1087
NOLH 200-500	280S-M	75	1450	2000x700	H180	200	250	200	870	2000	350	1300	2086	385	180	933	615	1175	425	560	830	790	25	4	1400
NOLH 200-500	280S-M	90	1450	2000x700	H180	200	250	200	870	2000	350	1300	2086	385	180	933	615	1175	425	560	830	790	25	4	1469
NOLH 250-300	225S-M	37	1450	1800x800	H140	250	300	305	960	1800	300	1200	1987	420	180	773	605	1155	425	550	930	890	25	4	1002
NOLH 250-300	225S-M	45	1450	1800x800	H140	250	300	305	960	1800	300	1200	1987	420	180	773	605	1155	425	550	930	890	25	4	1035
NOLH 250-300	250S-M	55	1450	1800x800	H160	250	300	305	960	1800	300	1200	2063	420	180	798	605	1155	425	550	930	890	25	4	1119
NOLH 250-300	280S-M	75	1450	2000x800	H180	250	300	305	960	2000	350	1300	2176	470	180	933	615	1165	425	550	930	890	25	4	1432
NOLH 250-315	200L	30	1450	1800x700	H125	250	300	250	920	1800	300	1200	1867	365	180	674	555	1115	375	560	830	790	25	4	876
NOLH 250-315	225S-M	37	1450	1800x700	H140	250	300	250	920	1800	300	1200	1947	365	180	773	555	1115	375	560	830	790	25	4	1000
NOLH 250-315	225S-M	45	1450	1800x700	H140	250	300	250	920	1800	300	1200	1947	365	180	773	555	1115	375	560	830	790	25	4	1033
NOLH 250-315	250S-M	55	1450	2000x700	H160	250	300	250	920	2000	350	1300	2023	415	180	808	565	1125	375	560	830	790	25	4	1140
NOLH 250-315	280S-M	75	1450	2000x700	H180	250	300	250	920	2000	350	1300	2136	415	180	933	565	1125	375	560	830	790	25	4	1430
NOLH 250-315	280S-M	90	1450	2000x700	H180	250	300	250	920	2000	350	1300	2136	415	180	933	565	1125	375	560	830	790	25	4	1499
NOLH 250-315	315S-M	110	1450	2100x740 F	H200	250	300	250	920	2140	370	1400	2256	480	180	930	498	1058	375	560	860	790	29	4	1719
NOLH 250-315	315S-M	132	1450	2100x740 F	H200	250	300	250	920	2140	370	1400	2256	480	180	930	498	1058	375	560	860	790	29	4	1869
NOLH 250-400	225S-M	37	1450	1800x800	H140	250	300	250	970	1800	300	1200	1997	365	180	773	580	1180	400	600	930	890	25	4	1051
NOLH 250-400	225S-M	45	1450	1800x800	H140	250	300	250	970	1800	300	1200	1997	365	180	773	580	1180	400	600	930	890	25	4	1084
NOLH 250-400	250S-M	55	1450	2000x800	H160	250	300	250	970	2000	350	1300	2073	415	180	808	590	1190	400	600	930	890	25	4	1192
NOLH 250-400	280S-M	75	1450	2100x740 F	H180	250	300	250	970	2140	370	1400	2186	480	180	866	523	1123	400	600	860	790	29	4	1617
NOLH 250-400	280S-M	90	1450	2100x740 F	H180	250	300	250	970	2140	370	1400	2186	480	180	866	523	1123	400	600	860	790	29	4	1686
NOLH 250-400	315S-M	110	1450	2100x740 F	H200	250	300	250	970	2140	370	1400	2306	480	180	930	523	1123	400	600	860	790	29	4	1761
NOLH 250-400	315S-M	132	1450	2100x740 F	H200	250	300	250	970	2140	370	1400	2306	480	180	930	523	1123	400	600	860	790	29	4	1910
NOLH 250-400	315S-M	160	1450	2100x740 F	H200	250	300	250	970	2140	370	1400	2306	480	180	930	523	1123	400	600	860	790	29	4	1910
NOLH 250-400	315B	200	1450	2500x800	H200	250	300	250	970	2500	250	1000	2720	305	180	1135	630	1230	400	600	950	890	28	6	2121
NOLH 250-400	355M-L	250	1450	2500x800	H225	250	300	250	970	2500	250	1000	2616	305	180	1265	630	1230	400	600	950	890	28	6	2516
NOLH 250-400	355M-L	315	1450	2500x800	H250	250	300	250	970	2500	250	1000	2616	305	180	1265	630	1230	400	600	950	890	28	6	2732
NOLH 250-400	355L	355	1450	2500x800	H250	250	300	250	970	2500	250	1000	2759	305	180	1165	630	1230	400	600	950	890	28	6	2773

* = C tes données ^ titre indicatif, ne pas utiliser ces valeurs pour réalisation.

DIMENSIONS – GROUPES – 1450 MIN-1 AVEC SPACER

Type pompe	Type moteur	Puissance nom. moteur (P2h en kW)	Vitesse	châssis	Accouplement	DND	DNS	a	LP	L1*	L2*	L3*	L*	S1	x	HM	Hs*	HP	H1	H2	B2*	B3*	Ø d*	n*	Poids groupe
NOLH 250-500	280S-M	75	1450	2000x800	H180	250	300	250	970	2000	350	1300	2186	415	180	933	640	1310	450	670	930	890	25	4	1610
NOLH 250-500	280S-M	90	1450	2000x800	H180	250	300	250	970	2000	350	1300	2186	415	180	933	640	1310	450	670	930	890	25	4	1679
NOLH 250-500	315S-M	110	1450	2250x800	H200	250	300	250	970	2250	225	900	2306	280	180	1037	680	1350	450	670	950	890	28	6	1849
NOLH 250-500	315S-M	132	1450	2250x800	H200	250	300	250	970	2250	225	900	2306	280	180	1037	680	1350	450	670	950	890	28	6	1999
NOLH 250-500	315S-M	160	1450	2250x800	H200	250	300	250	970	2250	225	900	2306	280	180	1037	680	1350	450	670	950	890	28	6	1999
NOLH 250-500	315B	200	1450	2500x800	H200	250	300	250	970	2500	250	1000	2720	305	180	1135	680	1350	450	670	950	890	28	6	2250
NOLH 250-500	355M-L	250	1450	2500x800	H225	250	300	250	970	2500	250	1000	2616	305	180	1265	680	1350	450	670	950	890	28	6	2645
NOLH 250-500	355M-L	315	1450	2500x800	H250	250	300	250	970	2500	250	1000	2616	305	180	1265	680	1350	450	670	950	890	28	6	2861
NOLH 250-500	355L	355	1450	2500x800	H250	250	300	250	970	2500	250	1000	2759	305	180	1165	680	1350	450	670	950	890	28	6	2902
NOLH 250-500	355J	400	1450	2500x800	H250	250	300	250	970	2500	250	1000	2929	305	180	1165	680	1350	450	670	950	890	28	6	3160
NOLH 300-400	225S-M	45	1450	1800x800	H140	300	350	300	1020	1800	300	1200	2047	410	180	773	605	1275	425	670	930	890	25	4	1245
NOLH 300-400	250S-M	55	1450	2000x800	H160	300	350	300	1020	2000	350	1300	2123	460	180	808	615	1285	425	670	930	890	25	4	1353
NOLH 300-400	280S-M	75	1450	2000x800	H180	300	350	300	1020	2000	350	1300	2236	460	180	933	615	1285	425	670	930	890	25	4	1642
NOLH 300-400	280S-M	90	1450	2000x800	H180	300	350	300	1020	2000	350	1300	2236	460	180	933	615	1285	425	670	930	890	25	4	1711
NOLH 300-400	315S-M	110	1450	2250x800	H200	300	350	300	1020	2250	225	900	2356	325	180	1037	655	1325	425	670	950	890	28	6	1881
NOLH 300-400	315S-M	132	1450	2250x800	H200	300	350	300	1020	2250	225	900	2356	325	180	1037	655	1325	425	670	950	890	28	6	2030
NOLH 300-400	315S-M	160	1450	2250x800	H200	300	350	300	1020	2250	225	900	2356	325	180	1037	655	1325	425	670	950	890	28	6	2030
NOLH 300-400	315B	200	1450	2500x800	H200	300	350	300	1020	2500	250	1000	2770	350	180	1135	655	1325	425	670	950	890	28	6	2282
NOLH 300-400	355M-L	250	1450	2500x800	H225	300	350	300	1020	2500	250	1000	2666	350	180	1265	655	1325	425	670	950	890	28	6	2677
NOLH 300-400	355M-L	315	1450	2500x800	H250	300	350	300	1020	2500	250	1000	2666	350	180	1265	655	1325	425	670	950	890	28	6	2893
NOLH 300-400	355L	355	1450	2500x800	H250	300	350	300	1020	2500	250	1000	2809	350	180	1165	655	1325	425	670	950	890	28	6	2934
NOLH 300-400	355J	400	1450	2500x800	H250	300	350	300	1020	2500	250	1000	2979	350	180	1165	655	1325	425	670	950	890	28	6	3192
NOLH 300-500	225S-M	45	1450	1800x900	H140	300	350	300	1020	1800	300	1200	2047	410	180	773	660	1330	480	670	1030	990	25	4	1440
NOLH 300-500	250S-M	55	1450	2000x900	H160	300	350	300	1020	2000	350	1300	2123	460	180	808	670	1340	480	670	1030	990	25	4	1547
NOLH 300-500	280S-M	75	1450	2000x900	H180	300	350	300	1020	2000	350	1300	2236	460	180	933	670	1340	480	670	1030	990	25	4	1837
NOLH 300-500	280S-M	90	1450	2000x900	H180	300	350	300	1020	2000	350	1300	2236	460	180	933	670	1340	480	670	1030	990	25	4	1906
NOLH 300-500	315S-M	110	1450	2250x900	H200	300	350	300	1020	2250	225	900	2356	325	180	1037	710	1380	480	670	1050	990	28	6	2079
NOLH 300-500	315S-M	132	1450	2250x900	H200	300	350	300	1020	2250	225	900	2356	325	180	1037	710	1380	480	670	1050	990	28	6	2228
NOLH 300-500	315S-M	160	1450	2250x900	H200	300	350	300	1020	2250	225	900	2356	325	180	1037	710	1380	480	670	1050	990	28	6	2228
NOLH 300-500	315B	200	1450	2500x900	H200	300	350	300	1020	2500	250	1000	2770	350	180	1135	710	1380	480	670	1050	990	28	6	2481
NOLH 300-500	355M-L	250	1450	2500x900	H225	300	350	300	1020	2500	250	1000	2666	350	180	1265	710	1380	480	670	1050	990	28	6	2876
NOLH 300-500	355M-L	315	1450	2500x900	H250	300	350	300	1020	2500	250	1000	2666	350	180	1265	710	1380	480	670	1050	990	28	6	3092
NOLH 300-500	355L	355	1450	2500x900	H250	300	350	300	1020	2500	250	1000	2809	350	180	1165	710	1380	480	670	1050	990	28	6	3133
NOLH 300-500	355J	400	1450	2500x900	H250	300	350	300	1020	2500	250	1000	2979	350	180	1165	710	1380	480	670	1050	990	28	6	3390
NOLH 300-500	355C	500	1450	3200x900	H280	300	350	300	1020	3200	250	900	3280	340	180	1214	750	1420	480	670	1070	1000	30	8	3941
NOLH 300-500	355D	560	1450	3200x900	H280	300	350	300	1020	3200	250	900	3280	340	180	1214	750	1420	480	670	1070	1000	30	8	4198
NOLH 300-500	400L	630	1450	3200x900	H315	300	350	300	1020	3200	250	900	3300	340	180	1296	750	1420	480	670	1070	1000	30	8	5177
NOLH 300-500	**	710	1450	**	**	300	350	300	1020	**	**	**	**	**	180	**	**	**	480	670	**	**	**	**	**

* = C tes donnÉes ` titre indicatif, ne pas utiliser ces valeurs pour rÉalisation. ** Nous consulter.

NOLH

DIMENSIONS – GROUPES – 1450 MIN-1 SANS SPACER

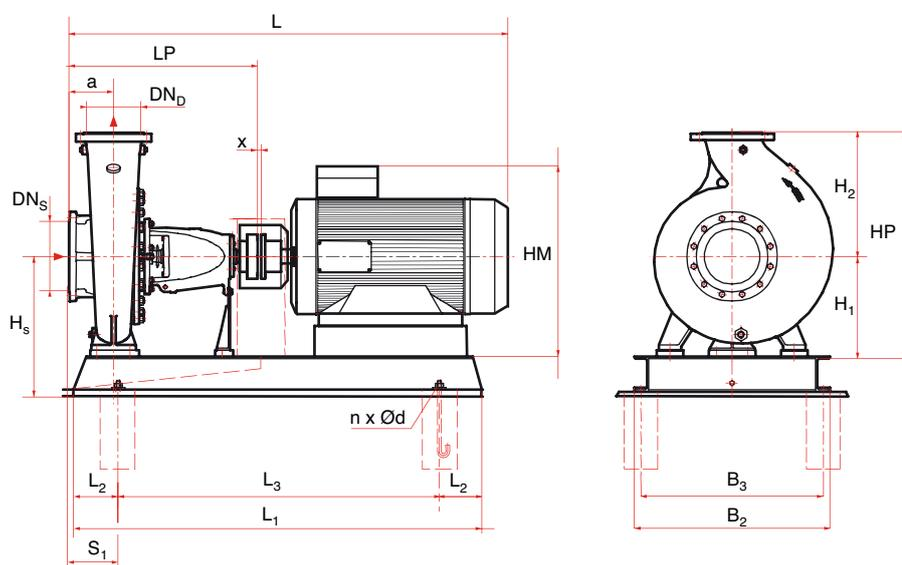

DIMENSIONS – GROUPES – 1450 MIN-1 SANS SPACER

Type pompe	Type moteur	Puissance nom. moteur (P _{2n} en kW)	Vitesse	châssis	Accouplement	DND	DNS	a	LP	L1*	L2*	L3*	L*	S1	x	HM	Hs*	HP	H1	H2	B2*	B3*	Ø d*	n*	Poids groupe
NOLH 032-125	71	0,37	1450	800 x 270 F	B80	32	50	80	440	840	150	540	692	160	4	139	112	335	112	140	360	320	19	4	88
NOLH 032-160	71	0,37	1450	800 x 270 F	B80	32	50	80	440	840	150	540	692	160	4	139	132	375	132	160	360	320	19	4	90
NOLH 032-160	80	0,55	1450	800 x 270 F	B80	32	50	80	440	840	150	540	720	160	4	210	132	375	132	160	360	320	19	4	93
NOLH 032-160	80	0,75	1450	800 x 270 F	B80	32	50	80	440	840	150	540	720	160	4	210	132	375	132	160	360	320	19	4	94
NOLH 032-200	80	0,55	1450	800 x 270 F	B80	32	50	80	440	840	150	540	720	160	4	210	160	423	160	180	360	320	19	4	94
NOLH 032-200	80	0,75	1450	800 x 270 F	B80	32	50	80	440	840	150	540	720	160	4	210	160	423	160	180	360	320	19	4	95
NOLH 032-200	90S	1,1	1450	800 x 270 F	B80	32	50	80	440	840	150	540	748	160	4	240	160	423	160	180	360	320	19	4	100
NOLH 032-200	90L	1,5	1450	800 x 270 F	B80	32	50	80	440	840	150	540	773	160	4	240	160	423	160	180	360	320	19	4	103
NOLH 032-250	80	0,75	1450	1000 x 340 F	B80	32	50	100	460	1040	190	660	740	207,5	4	210	180	508	180	225	450	400	24	4	131
NOLH 032-250	90S	1,1	1450	1000 x 340 F	B80	32	50	100	460	1040	190	660	768	207,5	4	240	180	508	180	225	450	400	24	4	135
NOLH 032-250	90L	1,5	1450	1000 x 340 F	B80	32	50	100	460	1040	190	660	793	207,5	4	240	180	508	180	225	450	400	24	4	139
NOLH 032-250	100L	2,2	1450	1000 x 340 F	B80	32	50	100	460	1040	190	660	840	207,5	4	260	180	508	180	225	450	400	24	4	148
NOLH 040-125	71	0,37	1450	800 x 270 F	B80	40	65	80	440	840	150	540	692	160	4	139	112	335	112	140	360	320	19	4	85
NOLH 040-125	80	0,55	1450	800 x 270 F	B80	40	65	80	440	840	150	540	720	160	4	210	112	335	112	140	360	320	19	4	88
NOLH 040-160	71	0,37	1450	800 x 270 F	B80	40	65	80	440	840	150	540	692	160	4	139	132	375	132	160	360	320	19	4	87
NOLH 040-160	80	0,55	1450	800 x 270 F	B80	40	65	80	440	840	150	540	720	160	4	210	132	375	132	160	360	320	19	4	90
NOLH 040-160	80	0,75	1450	800 x 270 F	B80	40	65	80	440	840	150	540	720	160	4	210	132	375	132	160	360	320	19	4	91
NOLH 040-160	90S	1,1	1450	800 x 270 F	B80	40	65	80	440	840	150	540	748	160	4	240	132	375	132	160	360	320	19	4	96
NOLH 040-160	90L	1,5	1450	800 x 270 F	B80	40	65	80	440	840	150	540	773	160	4	240	132	375	132	160	360	320	19	4	99
NOLH 040-200	80	0,55	1450	800 x 270 F	B80	40	65	100	460	840	150	540	740	180	4	210	160	423	160	180	360	320	19	4	96
NOLH 040-200	80	0,75	1450	800 x 270 F	B80	40	65	100	460	840	150	540	740	180	4	210	160	423	160	180	360	320	19	4	97
NOLH 040-200	90S	1,1	1450	800 x 270 F	B80	40	65	100	460	840	150	540	768	180	4	240	160	423	160	180	360	320	19	4	102

* = C tes données ^ titre indicatif, ne pas utiliser ces valeurs pour réalisation.

DIMENSIONS – GROUPES – 1450 MIN-1 SANS SPACER

Type pompe	Type moteur	Puissance norm. moteur (P2n en kW)	Vitesse	châssis	Accouplement	DND	DNS	a	LP	L1*	L2*	L3*	L*	S1	x	HM	Hs*	HP	H1	H2	B2*	B3*	Ø d*	n*	Poids groupe
NOLH 040-200	90L	1,5	1450	800 x 270 F	B80	40	65	100	460	840	150	540	793	180	4	240	160	423	160	180	360	320	19	4	106
NOLH 040-200	100L	2,2	1450	800 x 270 F	B80	40	65	100	460	840	150	540	840	180	4	260	160	423	160	180	360	320	19	4	114
NOLH 040-250	90S	1,1	1450	1000 x 340 F	B80	40	65	100	460	1040	190	660	768	207,5	4	240	180	508	180	225	450	400	24	4	135
NOLH 040-250	90L	1,5	1450	1000 x 340 F	B80	40	65	100	460	1040	190	660	793	207,5	4	240	180	508	180	225	450	400	24	4	139
NOLH 040-250	100L	2,2	1450	1000 x 340 F	B80	40	65	100	460	1040	190	660	840	207,5	4	260	180	508	180	225	450	400	24	4	148
NOLH 040-250	100L	3	1450	1000 x 340 F	B80	40	65	100	460	1040	190	660	840	207,5	4	260	180	508	180	225	450	400	24	4	151
NOLH 040-315	100L	2,2	1450	1120 x 380 F	B80	40	65	125	595	1160	210	740	975	252,5	4	260	225	578	225	250	490	440	24	4	211
NOLH 040-315	100L	3	1450	1120 x 380 F	B80	40	65	125	595	1160	210	740	975	252,5	4	260	225	578	225	250	490	440	24	4	214
NOLH 040-315	112M	4	1450	1120 x 380 F	B80	40	65	125	595	1160	210	740	992	252,5	4	292	225	578	225	250	490	440	24	4	226
NOLH 040-315	132S	5,5	1450	1120 x 380 F	B95	40	65	125	595	1160	210	740	1051	252,5	4	339	225	578	225	250	490	440	24	4	242
NOLH 050-125	71	0,37	1450	800 x 270 F	B80	50	65	100	460	840	150	540	712	180	4	139	132	375	132	160	360	320	19	4	87
NOLH 050-125	80	0,55	1450	800 x 270 F	B80	50	65	100	460	840	150	540	740	180	4	210	132	375	132	160	360	320	19	4	90
NOLH 050-125	80	0,75	1450	800 x 270 F	B80	50	65	100	460	840	150	540	740	180	4	210	132	375	132	160	360	320	19	4	91
NOLH 050-160	80	0,55	1450	800 x 270 F	B80	50	65	100	460	840	150	540	740	180	4	210	160	423	160	180	360	320	19	4	96
NOLH 050-160	80	0,75	1450	800 x 270 F	B80	50	65	100	460	840	150	540	740	180	4	210	160	423	160	180	360	320	19	4	97
NOLH 050-160	90S	1,1	1450	800 x 270 F	B80	50	65	100	460	840	150	540	768	180	4	240	160	423	160	180	360	320	19	4	102
NOLH 050-160	90L	1,5	1450	800 x 270 F	B80	50	65	100	460	840	150	540	793	180	4	240	160	423	160	180	360	320	19	4	106
NOLH 050-200	80	0,75	1450	800 x 270 F	B80	50	65	100	460	840	150	540	740	180	4	210	160	443	160	200	360	320	19	4	102
NOLH 050-200	90S	1,1	1450	800 x 270 F	B80	50	65	100	460	840	150	540	768	180	4	240	160	443	160	200	360	320	19	4	106
NOLH 050-200	90L	1,5	1450	800 x 270 F	B80	50	65	100	460	840	150	540	793	180	4	240	160	443	160	200	360	320	19	4	110
NOLH 050-200	100L	2,2	1450	800 x 270 F	B80	50	65	100	460	840	150	540	840	180	4	260	160	443	160	200	360	320	19	4	118
NOLH 050-200	100L	3	1450	800 x 270 F	B80	50	65	100	460	840	150	540	840	180	4	260	160	443	160	200	360	320	19	4	121
NOLH 050-250	90L	1,5	1450	1000 x 340 F	B80	50	65	100	460	1040	190	660	793	207,5	4	240	180	508	180	225	450	400	24	4	143
NOLH 050-250	100L	2,2	1450	1000 x 340 F	B80	50	65	100	460	1040	190	660	840	207,5	4	260	180	508	180	225	450	400	24	4	152
NOLH 050-250	100L	3	1450	1000 x 340 F	B80	50	65	100	460	1040	190	660	840	207,5	4	260	180	508	180	225	450	400	24	4	155
NOLH 050-250	112M	4	1450	1000 x 340 F	B80	50	65	100	460	1040	190	660	857	207,5	4	292	180	508	180	225	450	400	24	4	168
NOLH 050-315	112M	4	1450	1120 x 380 F	B95	50	65	125	595	1160	210	740	992	252,5	4	292	225	608	225	280	490	440	24	4	243
NOLH 050-315	132S	5,5	1450	1120 x 380 F	B95	50	65	125	595	1160	210	740	1051	252,5	4	339	225	608	225	280	490	440	24	4	258
NOLH 050-315	132M	7,5	1450	1120 x 380 F	B80	50	65	125	595	1160	210	740	1089	252,5	4	339	225	608	225	280	490	440	24	4	265
NOLH 050-315	132M	9	1450	1120 x 380 F	B80	50	65	125	595	1160	210	740	1089	252,5	4	339	225	608	225	280	490	440	24	4	270
NOLH 065-125	80	0,55	1450	900 x 300 F	B80	65	80	100	460	940	170	600	740	187,5	4	210	160	423	160	180	390	350	19	4	103
NOLH 065-125	80	0,75	1450	900 x 300 F	B80	65	80	100	460	940	170	600	740	187,5	4	210	160	423	160	180	390	350	19	4	105
NOLH 065-125	90S	1,1	1450	900 x 300 F	B80	65	80	100	460	940	170	600	768	187,5	4	240	160	423	160	180	390	350	19	4	109
NOLH 065-160	80	0,75	1450	900 x 300 F	B80	65	80	100	460	940	170	600	740	187,5	4	210	160	443	160	200	390	350	19	4	111
NOLH 065-160	90L	1,5	1450	900 x 300 F	B80	65	80	100	460	940	170	600	793	187,5	4	240	160	443	160	200	390	350	19	4	119
NOLH 065-160	100L	2,2	1450	900 x 300 F	B80	65	80	100	460	940	170	600	840	187,5	4	260	160	443	160	200	390	350	19	4	128
NOLH 065-200	90S	1,1	1450	1000 x 340 F	B80	65	80	100	460	1040	190	660	768	207,5	4	240	180	508	180	225	450	400	24	4	134
NOLH 065-200	90L	1,5	1450	1000 x 340 F	B80	65	80	100	460	1040	190	660	793	207,5	4	240	180	508	180	225	450	400	24	4	138
NOLH 065-200	100L	2,2	1450	1000 x 340 F	B80	65	80	100	460	1040	190	660	840	207,5	4	260	180	508	180	225	450	400	24	4	147
NOLH 065-200	100L	3	1450	1000 x 340 F	B80	65	80	100	460	1040	190	660	840	207,5	4	260	180	508	180	225	450	400	24	4	150
NOLH 065-200	112M	4	1450	1000 x 340 F	B80	65	80	100	460	1040	190	660	857	207,5	4	292	180	508	180	225	450	400	24	4	162

* = C tes données ` titre indicatif, ne pas utiliser ces valeurs pour rcalisation.

NOLH

DIMENSIONS – GROUPES – 1450 MIN-1 SANS SPACER

Type pompe	Type moteur	Puissance nom. moteur (P2n en kW)	Vitesse	châssis	Accouplement	DND	DNS	a	LP	L1*	L2*	L3*	L*	S1	x	HMI	Hs*	HP	H1	H2	B2*	B3*	Ø d*	n*	Poids groupe
NOLH 065-250	100L	2,2	1450	1120 x 380 F	B80	65	80	100	570	1160	210	740	950	210	4	260	200	553	200	250	490	440	24	4	207
NOLH 065-250	100L	3	1450	1120 x 380 F	B80	65	80	100	570	1160	210	740	950	210	4	260	200	553	200	250	490	440	24	4	211
NOLH 065-250	112M	4	1450	1120 x 380 F	B80	65	80	100	570	1160	210	740	967	210	4	292	200	553	200	250	490	440	24	4	223
NOLH 065-250	132S	5,5	1450	1120 x 380 F	B95	65	80	100	570	1160	210	740	1026	210	4	339	200	553	200	250	490	440	24	4	239
NOLH 065-315	132M	9	1450	1250 x 430 F	B95	65	80	125	595	1310	235	840	1089	260	4	339	225	608	225	280	540	490	24	4	307
NOLH 065-315	160M	5,5	1450	1250 x 430 F	B95	65	80	125	595	1310	235	840	1197	260	4	410	225	608	225	280	540	490	24	4	341
NOLH 065-315	160L	7,5	1450	1250 x 430 F	B95	65	80	125	595	1310	235	840	1241	260	4	410	225	608	225	280	540	490	24	4	358
NOLH 065-315	132S	11	1450	1250 x 430 F	B95	65	80	125	595	1310	235	840	1051	260	4	339	225	608	225	280	540	490	24	4	294
NOLH 065-315	132M	15	1450	1250 x 430 F	B110	65	80	125	595	1310	235	840	1089	260	4	339	225	608	225	280	540	490	24	4	303
NOLH 080-160	80	0,75	1450	1000 x 340 F	B80	80	100	125	485	1040	190	660	765	232,5	4	210	180	508	180	225	450	400	24	4	128
NOLH 080-160	90S	1,1	1450	1000 x 340 F	B80	80	100	125	485	1040	190	660	793	232,5	4	240	180	508	180	225	450	400	24	4	132
NOLH 080-160	90L	1,5	1450	1000 x 340 F	B80	80	100	125	485	1040	190	660	818	232,5	4	240	180	508	180	225	450	400	24	4	136
NOLH 080-160	100L	2,2	1450	1000 x 340 F	B80	80	100	125	485	1040	190	660	865	232,5	4	260	180	508	180	225	450	400	24	4	144
NOLH 080-160	100L	3	1450	1000 x 340 F	B80	80	100	125	485	1040	190	660	865	232,5	4	260	180	508	180	225	450	400	24	4	148
NOLH 080-160	112M	4	1450	1000 x 340 F	B80	80	100	125	485	1040	190	660	882	232,5	4	292	180	508	180	225	450	400	24	4	160
NOLH 080-200	90L	1,5	1450	1120 x 380 F	B80	80	100	125	595	1160	210	740	928	309	4	240	180	533	180	250	490	440	24	4	189
NOLH 080-200	100L	2,2	1450	1120 x 380 F	B80	80	100	125	595	1160	210	740	975	309	4	260	180	533	180	250	490	440	24	4	197
NOLH 080-200	100L	3	1450	1120 x 380 F	B80	80	100	125	595	1160	210	740	975	309	4	260	180	533	180	250	490	440	24	4	200
NOLH 080-200	112M	4	1450	1120 x 380 F	B80	80	100	125	595	1160	210	740	992	309	4	292	180	533	180	250	490	440	24	4	213
NOLH 080-200	132S	5,5	1450	1120 x 380 F	B95	80	100	125	595	1160	210	740	1051	309	4	339	180	533	180	250	490	440	24	4	229
NOLH 080-250	100L	3	1450	1250 x 430 F	B80	80	100	125	595	1310	235	840	975	260	4	260	200	583	200	280	540	490	24	4	247
NOLH 080-250	112M	4	1450	1250 x 430 F	B80	80	100	125	595	1310	235	840	992	260	4	292	200	583	200	280	540	490	24	4	260
NOLH 080-250	132S	5,5	1450	1250 x 430 F	B95	80	100	125	595	1310	235	840	1051	260	4	339	200	583	200	280	540	490	24	4	276
NOLH 080-250	132M	7,5	1450	1250 x 430 F	B95	80	100	125	595	1310	235	840	1089	260	4	339	200	583	200	280	540	490	24	4	284
NOLH 080-315	132S	5,5	1450	1250 x 430 F	B95	80	100	125	595	1310	235	840	1051	260	4	339	250	668	250	315	540	490	24	4	297
NOLH 080-315	132M	7,5	1450	1250 x 430 F	B95	80	100	125	595	1310	235	840	1089	260	4	339	250	668	250	315	540	490	24	4	305
NOLH 080-315	132M	9	1450	1250 x 430 F	B95	80	100	125	595	1310	235	840	1089	260	4	339	250	668	250	315	540	490	24	4	310
NOLH 080-315	160M	11	1450	1250 x 430 F	B95	80	100	125	595	1310	235	840	1197	260	4	410	250	668	250	315	540	490	24	4	344
NOLH 080-315	160L	15	1450	1250 x 430 F	B110	80	100	125	595	1310	235	840	1241	260	4	410	250	668	250	315	540	490	24	4	362
NOLH 080-400	160M	11	1450	1400 x 480 F	B95	80	125	125	655	1460	260	940	1257	285	4	410	280	738	280	355	610	550	29	4	442
NOLH 080-400	160L	15	1450	1400 x 480 F	B95	80	125	125	655	1460	260	940	1301	285	4	410	280	738	280	355	610	550	29	4	458
NOLH 080-400	180M	18,5	1450	1400 x 480 F	B110	80	125	125	655	1460	260	940	1323	285	4	450	280	738	280	355	610	550	29	4	501
NOLH 080-400	180L	22	1450	1400 x 480 F	B110	80	125	125	655	1460	260	940	1361	285	4	450	280	738	280	355	610	550	29	4	525
NOLH 080-400	200L	30	1450	1400 x 480 F	B125	80	125	125	655	1460	260	940	1426	285	4	494	280	738	280	355	610	550	29	4	580
NOLH 100-160	100L	2,2	1450	1120 x 380 F	B80	100	125	125	595	1160	210	740	975	235	4	260	200	583	200	280	490	440	24	4	216
NOLH 100-160	100L	3	1450	1120 x 380 F	B80	100	125	125	595	1160	210	740	975	235	4	260	200	583	200	280	490	440	24	4	219
NOLH 100-160	112M	4	1450	1120 x 380 F	B80	100	125	125	595	1160	210	740	992	235	4	292	200	583	200	280	490	440	24	4	232
NOLH 100-160	132S	5,5	1450	1120 x 380 F	B95	100	125	125	595	1160	210	740	1051	235	4	339	200	583	200	280	490	440	24	4	247
NOLH 100-200	100L	2,2	1450	1120 x 380 F	B80	100	125	125	595	1160	210	740	975	235	4	260	200	583	200	280	490	440	24	4	207
NOLH 100-200	100L	3	1450	1120 x 380 F	B80	100	125	125	595	1160	210	740	975	235	4	260	200	583	200	280	490	440	24	4	211
NOLH 100-200	112M	4	1450	1120 x 380 F	B80	100	125	125	595	1160	210	740	992	235	4	292	200	583	200	280	490	440	24	4	223

* = C tes données ^ titre indicatif, ne pas utiliser ces valeurs pour réalisation.

DIMENSIONS – GROUPES – 1450 MIN-1 SANS SPACER

Type pompe	Type moteur	Puissance norm. moteur (P2n en kW)	Vitesse	châssis	Accouplement	DND	DNS	a	LP	L1*	L2*	L3*	L*	S1	x	HM	Hs*	HP	H1	H2	B2*	B3*	Ø d*	n*	Poids groupe
NOLH 100-200	132S	5,5	1450	1120 x 380 F	B95	100	125	125	595	1160	210	740	1051	235	4	339	200	583	200	280	490	440	24	4	239
NOLH 100-200	132M	7,5	1450	1120 x 380 F	B95	100	125	125	595	1160	210	740	1089	235	4	339	200	583	200	280	490	440	24	4	247
NOLH 100-250	112M	4	1450	1250 x 430 F	B80	100	125	140	610	1310	235	840	1007	275	4	292	225	608	225	280	540	490	24	4	270
NOLH 100-250	132S	5,5	1450	1250 x 430 F	B95	100	125	140	610	1310	235	840	1066	275	4	339	225	608	225	280	540	490	24	4	286
NOLH 100-250	132M	7,5	1450	1250 x 430 F	B95	100	125	140	610	1310	235	840	1104	275	4	339	225	608	225	280	540	490	24	4	295
NOLH 100-250	132M	9	1450	1250 x 430 F	B95	100	125	140	610	1310	235	840	1104	275	4	339	225	608	225	280	540	490	24	4	300
NOLH 100-250	160M	11	1450	1250 x 430 F	B95	100	125	140	610	1310	235	840	1212	275	4	410	225	608	225	280	540	490	24	4	334
NOLH 100-315	160M	11	1450	1250 x 430 F	B95	100	125	140	610	1310	235	840	1212	275	4	410	250	668	250	315	540	490	24	4	353
NOLH 100-315	160L	15	1450	1250 x 430 F	B110	100	125	140	610	1310	235	840	1256	275	4	410	250	668	250	315	540	490	24	4	372
NOLH 100-315	180M	18,5	1450	1250 x 430 F	B110	100	125	140	610	1310	235	840	1278	275	4	450	250	668	250	315	540	490	24	4	413
NOLH 100-315	180L	22	1450	1250 x 430 F	B125	100	125	140	610	1310	235	840	1316	275	4	450	250	668	250	315	540	490	24	4	439
NOLH 100-400	160L	15	1450	1600 x 530 F	B95	100	125	140	670	1660	300	1060	1316	320	4	410	280	758	280	355	660	600	29	4	535
NOLH 100-400	180M	18,5	1450	1600 x 530 F	B110	100	125	140	670	1660	300	1060	1338	320	4	450	280	758	280	355	660	600	29	4	577
NOLH 100-400	180L	22	1450	1600 x 530 F	B110	100	125	140	670	1660	300	1060	1376	320	4	450	280	758	280	355	660	600	29	4	602
NOLH 100-400	200L	30	1450	1600 x 530 F	B125	100	125	140	670	1660	300	1060	1441	320	4	494	280	758	280	355	660	600	29	4	657
NOLH 100-400	225S-M	37	1450	1600 x 530 F	B140	100	125	140	670	1660	300	1060	1521	320	4	593	280	758	280	355	660	600	29	4	780
NOLH 100-400	225S-M	45	1450	1600 x 530 F	B140	100	125	140	670	1660	300	1060	1521	320	4	593	280	758	280	355	660	600	29	4	814
NOLH 125-200	132M	7,5	1450	1250 x 430 F	B95	125	150	140	610	1310	235	840	1104	275	4	339	250	668	250	315	540	490	24	4	310
NOLH 125-200	132M	9	1450	1250 x 430 F	B95	125	150	140	610	1310	235	840	1104	275	4	339	250	668	250	315	540	490	24	4	316
NOLH 125-200	160M	11	1450	1250 x 430 F	B95	125	150	140	610	1310	235	840	1212	275	4	410	250	668	250	315	540	490	24	4	349
NOLH 125-200	160L	15	1450	1250 x 430 F	B110	125	150	140	610	1310	235	840	1256	275	4	410	250	668	250	315	540	490	24	4	367
NOLH 125-250	132M	7,5	1450	1250 x 430 F	B95	125	150	140	610	1310	235	840	1104	275	4	339	250	708	250	355	540	490	24	4	313
NOLH 125-250	132M	9	1450	1250 x 430 F	B95	125	150	140	610	1310	235	840	1104	275	4	339	250	708	250	355	540	490	24	4	318
NOLH 125-250	160M	11	1450	1250 x 430 F	B95	125	150	140	610	1310	235	840	1212	275	4	410	250	708	250	355	540	490	24	4	351
NOLH 125-250	160L	15	1450	1250 x 430 F	B110	125	150	140	610	1310	235	840	1256	275	4	410	250	708	250	355	540	490	24	4	370
NOLH 125-250	180M	18,5	1450	1250 x 430 F	B110	125	150	140	610	1310	235	840	1278	275	4	450	250	708	250	355	540	490	24	4	410
NOLH 125-315	160L	15	1450	1600 x 530 F	B95	125	150	140	670	1660	300	1060	1316	320	4	410	280	758	280	355	660	600	29	4	508
NOLH 125-315	180M	18,5	1450	1600 x 530 F	B110	125	150	140	670	1660	300	1060	1338	320	4	450	280	758	280	355	660	600	29	4	550
NOLH 125-315	180L	22	1450	1600 x 530 F	B110	125	150	140	670	1660	300	1060	1376	320	4	450	280	758	280	355	660	600	29	4	574
NOLH 125-315	200L	30	1450	1600 x 530 F	B125	125	150	140	670	1660	300	1060	1441	320	4	494	280	758	280	355	660	600	29	4	629
NOLH 125-315	225S-M	37	1450	1600 x 530 F	B140	125	150	140	670	1660	300	1060	1521	320	4	593	280	758	280	355	660	600	29	4	753
NOLH 125-400	200L	30	1450	1600 x 530 F	B125	125	150	140	670	1660	300	1060	1441	320	4	494	315	838	315	400	660	600	29	4	668
NOLH 125-400	225S-M	37	1450	1600 x 530 F	B140	125	150	140	670	1660	300	1060	1521	320	4	593	315	838	315	400	660	600	29	4	792
NOLH 125-400	225S-M	45	1450	1600 x 530 F	B140	125	150	140	670	1660	300	1060	1521	320	4	593	315	838	315	400	660	600	29	4	825
NOLH 125-400	250S-M	55	1450	1600 x 530 F	B160	125	150	140	670	1660	300	1060	1599	320	6	618	315	838	315	400	660	600	29	4	910
NOLH 125-400	280S-M	75	1450	1600 x 530 F	B180	125	150	140	670	1660	300	1060	1712	320	6	743	315	838	315	400	660	600	29	4	1203
NOLH 150-200	132M	7,5	1450	1800 x 600 F	B95	150	200	160	630	1860	330	1200	1124	370	4	339	280	803	280	400	730	670	29	4	518
NOLH 150-200	132M	9	1450	1800 x 600 F	B95	150	200	160	630	1860	330	1200	1124	370	4	339	280	803	280	400	730	670	29	4	524
NOLH 150-200	160M	11	1450	1800 x 600 F	B95	150	200	160	630	1860	330	1200	1232	370	4	410	280	803	280	400	730	670	29	4	557
NOLH 150-200	160L	15	1450	1800 x 600 F	B110	150	200	160	630	1860	330	1200	1276	370	4	410	280	803	280	400	730	670	29	4	575
NOLH 150-200	180M	18,5	1450	1800 x 600 F	B110	150	200	160	630	1860	330	1200	1298	370	4	450	280	803	280	400	730	670	29	4	616

* = C tes donnés titre indicatif, ne pas utiliser ces valeurs pour réalisation.

NOLH

DIMENSIONS – GROUPES – 1450 MIN-1 SANS SPACER

Type pompe	Type moteur	Puissance nom. moteur (P2n en kW)	Vitesse	châssis	Accouplement	DND	DNS	a	LP	L1*	L2*	L3*	L*	S1	x	HMI	Hs*	HP	H1	H2	B2*	B3*	Ø d*	n*	Poids groupe
NOLH 150-250	160L	15	1450	1600 x 530 F	B110	150	200	160	630	1660	300	1060	1276	340	4	410	280	803	280	400	660	600	29	4	485
NOLH 150-250	180M	18,5	1450	1600 x 530 F	B110	150	200	160	630	1660	300	1060	1298	340	4	450	280	803	280	400	660	600	29	4	526
NOLH 150-250	180L	22	1450	1600 x 530 F	B125	150	200	160	630	1660	300	1060	1336	340	4	450	280	803	280	400	660	600	29	4	553
NOLH 150-250	200L	30	1450	1600 x 530 F	B140	150	200	160	630	1660	300	1060	1401	340	4	494	280	803	280	400	660	600	29	4	606
NOLH 150-315	180L	22	1450	1800 x 600 F	B110	150	200	160	690	1860	330	1200	1396	370	4	450	280	803	280	400	730	670	29	4	690
NOLH 150-315	200L	30	1450	1800 x 600 F	B125	150	200	160	690	1860	330	1200	1461	370	4	494	280	803	280	400	730	670	29	4	745
NOLH 150-315	225S-M	37	1450	1800 x 600 F	B140	150	200	160	690	1860	330	1200	1541	370	4	593	280	803	280	400	730	670	29	4	868
NOLH 150-315	225S-M	45	1450	1800 x 600 F	B140	150	200	160	690	1860	330	1200	1541	370	4	593	280	803	280	400	730	670	29	4	902
NOLH 150-315	250S-M	55	1450	1800 x 600 F	B160	150	200	160	690	1860	330	1200	1619	370	6	618	280	803	280	400	730	670	29	4	986
NOLH 150-400	225S-M	45	1450	1800 x 600 F	B140	150	200	160	690	1860	330	1200	1541	370	4	593	315	888	315	450	730	670	29	4	939
NOLH 150-400	250S-M	55	1450	1800 x 600 F	B160	150	200	160	690	1860	330	1200	1619	370	6	618	315	888	315	450	730	670	29	4	1023
NOLH 150-400	280S-M	75	1450	1800 x 600 F	B180	150	200	160	690	1860	330	1200	1732	370	6	743	315	888	315	450	730	670	29	4	1317
NOLH 150-400	280S-M	90	1450	1800 x 600 F	B180	150	200	160	690	1860	330	1200	1732	370	6	743	315	888	315	450	730	670	29	4	1387
NOLH 150-500	315S-M	110	1450	2100x740 F	B200	150	200	180	850	2140	370	1400	2012	430	6	930	523	1023	400	500	860	790	29	4	1617
NOLH 150-500	315S-M	132	1450	2100x740 F	B200	150	200	180	850	2140	370	1400	2012	430	6	930	523	1023	400	500	860	790	29	4	1767
NOLH 150-500	315S-M	160	1450	2100x740 F	B200	150	200	180	850	2140	370	1400	2012	430	6	930	523	1023	400	500	860	790	29	4	1767
NOLH 150-500	315B	200	1450	2100x740 F	B200	150	200	180	850	2140	370	1400	2426	430	6	1028	523	1023	400	500	860	790	29	4	2003
NOLH 150-500	355M-L	250	1450	2250x800	B225	150	200	180	850	2250	225	900	2322	230	6	1265	630	1130	400	500	950	890	28	6	2354
NOLH 150-500	180L	22	1450	1600x700	B125	150	200	180	850	1600	270	1060	1556	295	4	590	540	1040	400	500	810	790	20	4	685
NOLH 150-500	200L	30	1450	1600x700	B125	150	200	180	850	1600	270	1060	1621	295	4	634	540	1040	400	500	810	790	20	4	737
NOLH 150-500	225S-M	37	1450	1600x700	B140	150	200	180	850	1600	270	1060	1701	295	4	733	540	1040	400	500	810	790	20	4	858
NOLH 150-500	225S-M	45	1450	1600x700	B140	150	200	180	850	1600	270	1060	1701	295	4	733	540	1040	400	500	810	790	20	4	891
NOLH 150-500	250S-M	55	1450	1600x700	B160	150	200	180	850	1600	270	1060	1779	295	6	758	540	1040	400	500	810	790	20	4	974
NOLH 150-500	280S-M	75	1450	1800x700	B180	150	200	180	850	1800	300	1200	1892	315	6	923	580	1080	400	500	830	790	25	4	1307
NOLH 150-500	280S-M	90	1450	1800x700	B180	150	200	180	850	1800	300	1200	1892	315	6	923	580	1080	400	500	830	790	25	4	1376
NOLH 200-250	160L	15	1450	1600x530 F	B110	200	200	160	750	1660	300	1060	1396	330	4	533	403	803	280	400	660	600	29	4	581
NOLH 200-250	180M	18,5	1450	1600x530 F	B110	200	200	160	750	1660	300	1060	1418	330	4	573	403	803	280	400	660	600	29	4	621
NOLH 200-250	180L	22	1450	1600x530 F	B110	200	200	160	750	1660	300	1060	1456	330	4	573	403	803	280	400	660	600	29	4	645
NOLH 200-250	200L	30	1450	1600x530 F	B125	200	200	160	750	1660	300	1060	1521	330	4	617	403	803	280	400	660	600	29	4	699
NOLH 200-315	180L	22	1450	1800x600 F	B125	200	250	200	870	1860	330	1200	1576	400	4	573	478	928	355	450	730	670	29	4	823
NOLH 200-315	200L	30	1450	1800x600 F	B125	200	250	200	870	1860	330	1200	1641	400	4	617	478	928	355	450	730	670	29	4	875
NOLH 200-315	225S-M	37	1450	1800x600 F	B140	200	250	200	870	1860	330	1200	1721	400	4	716	478	928	355	450	730	670	29	4	996
NOLH 200-315	225S-M	45	1450	1800x600 F	B140	200	250	200	870	1860	330	1200	1721	400	4	716	478	928	355	450	730	670	29	4	1029
NOLH 200-315	250S-M	55	1450	1800x600 F	B160	200	250	200	870	1860	330	1200	1799	400	6	741	478	928	355	450	730	670	29	4	1112
NOLH 200-315	280S-M	75	1450	1800x600 F	B180	200	250	200	870	1860	330	1200	1912	400	6	866	478	928	355	450	730	670	29	4	1400
NOLH 200-400	315S-M	110	1450	2100x740 F	B200	200	250	180	850	2140	370	1400	2012	430	6	930	478	978	355	500	860	790	29	4	1622
NOLH 200-400	315S-M	132	1450	2100x740 F	B200	200	250	180	850	2140	370	1400	2012	430	6	930	478	978	355	500	860	790	29	4	1772
NOLH 200-400	315S-M	160	1450	2100x740 F	B200	200	250	180	850	2140	370	1400	2012	430	6	930	478	978	355	500	860	790	29	4	1772
NOLH 200-400	315B	200	1450	2100x740 F	B200	200	250	180	850	2140	370	1400	2426	430	6	1028	478	978	355	500	860	790	29	4	2009
NOLH 200-400	355M-L	250	1450	2250x800	B225	200	250	180	850	2250	225	900	2322	230	6	1265	585	1085	355	500	950	890	28	6	2359
NOLH 200-400	180L	22	1450	1800x600 F	B125	200	250	180	850	1860	330	1200	1556	380	4	573	478	978	355	500	730	670	29	4	854

* = C tes données ^ titre indicatif, ne pas utiliser ces valeurs pour réalisation.

DIMENSIONS – GROUPES – 1450 MIN-1 SANS SPACER

Type pompe	Type moteur	Puissance norm. moteur (P2n en kW)	Vitesse	châssis	Accouplement	DND	DNS	a	LP	L1*	L2*	L3*	L*	S1	x	HM	Hs*	HP	H1	H2	B2*	B3*	Ø d*	n*	Poids groupe
NOLH 200-400	200L	30	1450	1800x600 F	B125	200	250	180	850	1860	330	1200	1621	380	4	617	478	978	355	500	730	670	29	4	906
NOLH 200-400	225S-M	37	1450	1800x600 F	B140	200	250	180	850	1860	330	1200	1701	380	4	716	478	978	355	500	730	670	29	4	1027
NOLH 200-400	225S-M	45	1450	1800x600 F	B140	200	250	180	850	1860	330	1200	1701	380	4	716	478	978	355	500	730	670	29	4	1060
NOLH 200-400	250S-M	55	1450	1800x600 F	B160	200	250	180	850	1860	330	1200	1779	380	6	741	478	978	355	500	730	670	29	4	1143
NOLH 200-400	280S-M	75	1450	1800x600 F	B180	200	250	180	850	1860	330	1200	1892	380	6	866	478	978	355	500	730	670	29	4	1431
NOLH 200-400	280S-M	90	1450	1800x600 F	B180	200	250	180	850	1860	330	1200	1892	380	6	866	478	978	355	500	730	670	29	4	1500
NOLH 200-500	315S-M	110	1450	2100x740 F	B200	200	250	200	870	2140	370	1400	2032	450	6	930	548	1108	425	560	860	790	29	4	1679
NOLH 200-500	315S-M	132	1450	2100x740 F	B200	200	250	200	870	2140	370	1400	2032	450	6	930	548	1108	425	560	860	790	29	4	1828
NOLH 200-500	315S-M	160	1450	2100x740 F	B200	200	250	200	870	2140	370	1400	2032	450	6	930	548	1108	425	560	860	790	29	4	1828
NOLH 200-500	315B	200	1450	2250x700	B200	200	250	200	870	2250	225	900	2446	250	6	1135	655	1215	425	560	850	790	28	6	2012
NOLH 200-500	355M-L	250	1450	2250x800	B225	200	250	200	870	2250	225	900	2342	250	6	1265	655	1215	425	560	950	890	28	6	2416
NOLH 200-500	355M-L	315	1450	2250x800	B250	200	250	200	870	2250	225	900	2344	250	8	1265	655	1215	425	560	950	890	28	6	2627
NOLH 200-500	355L	355	1450	2250x800	B250	200	250	200	870	2250	225	900	2487	250	8	1165	655	1215	425	560	950	890	28	6	2668
NOLH 200-500	225S-M	45	1450	1600x700	B140	200	250	200	870	1600	270	1060	1721	315	4	733	565	1125	425	560	810	790	20	4	953
NOLH 200-500	250S-M	55	1450	1600x700	B160	200	250	200	870	1600	270	1060	1799	315	6	758	565	1125	425	560	810	790	20	4	1036
NOLH 200-500	280S-M	75	1450	1800x700	B180	200	250	200	870	1800	300	1200	1912	335	6	923	605	1165	425	560	830	790	25	4	1369
NOLH 200-500	280S-M	90	1450	1800x700	B180	200	250	200	870	1800	300	1200	1912	335	6	923	605	1165	425	560	830	790	25	4	1438
NOLH 250-300	225S-M	37	1450	1600x700	B140	250	300	305	960	1600	270	1060	1811	400	4	733	565	1115	425	550	810	790	20	4	941
NOLH 250-300	225S-M	45	1450	1600x700	B140	250	300	305	960	1600	270	1060	1811	400	4	733	565	1115	425	550	810	790	20	4	974
NOLH 250-300	250S-M	55	1450	1600x700	B160	250	300	305	960	1600	270	1060	1889	400	6	758	565	1115	425	550	810	790	20	4	1057
NOLH 250-300	280S-M	75	1450	1800x700	B180	250	300	305	960	1800	300	1200	2002	420	6	923	605	1155	425	550	830	790	25	4	1391
NOLH 250-315	200L	30	1450	1600x700	B125	250	300	250	920	1600	270	1060	1691	345	4	634	515	1075	375	560	810	790	20	4	828
NOLH 250-315	225S-M	37	1450	1600x700	B140	250	300	250	920	1600	270	1060	1771	345	4	733	515	1075	375	560	810	790	20	4	950
NOLH 250-315	225S-M	45	1450	1600x700	B140	250	300	250	920	1600	270	1060	1771	345	4	733	515	1075	375	560	810	790	20	4	983
NOLH 250-315	250S-M	55	1450	1800x700	B160	250	300	250	920	1800	300	1200	1849	365	6	798	555	1115	375	560	830	790	25	4	1111
NOLH 250-315	280S-M	75	1450	1800x700	B180	250	300	250	920	1800	300	1200	1962	365	6	923	555	1115	375	560	830	790	25	4	1399
NOLH 250-315	280S-M	90	1450	1800x700	B180	250	300	250	920	1800	300	1200	1962	365	6	923	555	1115	375	560	830	790	25	4	1468
NOLH 250-315	315S-M	110	1450	2100x740 F	B200	250	300	250	920	2140	370	1400	2082	480	6	930	498	1058	375	560	860	790	29	4	1709
NOLH 250-315	315S-M	132	1450	2100x740 F	B200	250	300	250	920	2140	370	1400	2082	480	6	930	498	1058	375	560	860	790	29	4	1858
NOLH 250-400	225S-M	37	1450	1600x700	B140	250	300	250	970	1600	270	1060	1821	345	4	733	540	1140	400	600	810	790	20	4	991
NOLH 250-400	225S-M	45	1450	1600x700	B140	250	300	250	970	1600	270	1060	1821	345	4	733	540	1140	400	600	810	790	20	4	1024
NOLH 250-400	250S-M	55	1450	1800x700	B160	250	300	250	970	1800	300	1200	1899	365	6	798	580	1180	400	600	830	790	25	4	1152
NOLH 250-400	280S-M	75	1450	2100x740 F	B180	250	300	250	970	2140	370	1400	2012	480	6	866	523	1123	400	600	860	790	29	4	1610
NOLH 250-400	280S-M	90	1450	2100x740 F	B180	250	300	250	970	2140	370	1400	2012	480	6	866	523	1123	400	600	860	790	29	4	1679
NOLH 250-400	315S-M	110	1450	2100x740 F	B200	250	300	250	970	2140	370	1400	2132	480	6	930	523	1123	400	600	860	790	29	4	1750
NOLH 250-400	315S-M	132	1450	2100x740 F	B200	250	300	250	970	2140	370	1400	2132	480	6	930	523	1123	400	600	860	790	29	4	1899
NOLH 250-400	315S-M	160	1450	2100x740 F	B200	250	300	250	970	2140	370	1400	2132	480	6	930	523	1123	400	600	860	790	29	4	1899
NOLH 250-400	315B	200	1450	2250x700	B200	250	300	250	970	2250	225	900	2546	280	6	1135	630	1230	400	600	850	790	28	6	2083
NOLH 250-400	355M-L	250	1450	2250x800	B225	250	300	250	970	2250	225	900	2442	280	6	1265	630	1230	400	600	950	890	28	6	2487
NOLH 250-400	355M-L	315	1450	2250x800	B250	250	300	250	970	2250	225	900	2444	280	8	1265	630	1230	400	600	950	890	28	6	2698
NOLH 250-400	355L	355	1450	2250x800	B250	250	300	250	970	2250	225	900	2587	280	8	1165	630	1230	400	600	950	890	28	6	2739

* = C tes données titre indicatif, ne pas utiliser ces valeurs pour réalisation.

NOLH

DIMENSIONS – GROUPES – 1450 MIN-1 SANS SPACER

Type pompe	Type moteur	Puissance nom. moteur (P2n en kW)	Vitesse	châssis	Accouplement	DND	DNS	a	LP	L1*	L2*	L3*	L*	S1	x	HMI	Hs*	HP	H1	H2	B2*	B3*	Ø d*	n*	Poids groupe
NOLH 250-500	280S-M	75	1450	1800x800	B180	250	300	250	970	1800	300	1200	2012	365	6	923	630	1300	450	670	930	890	25	4	1579
NOLH 250-500	280S-M	90	1450	1800x800	B180	250	300	250	970	1800	300	1200	2012	365	6	923	630	1300	450	670	930	890	25	4	1648
NOLH 250-500	315S-M	110	1450	2000x800	B200	250	300	250	970	2000	350	1300	2132	415	6	997	640	1310	450	670	930	890	25	4	1743
NOLH 250-500	315S-M	132	1450	2000x800	B200	250	300	250	970	2000	350	1300	2132	415	6	997	640	1310	450	670	930	890	25	4	1892
NOLH 250-500	315S-M	160	1450	2000x800	B200	250	300	250	970	2000	350	1300	2132	415	6	997	640	1310	450	670	930	890	25	4	1892
NOLH 250-500	315B	200	1450	2250x800	B200	250	300	250	970	2250	225	900	2546	280	6	1135	680	1350	450	670	950	890	28	6	2225
NOLH 250-500	355M-L	250	1450	2250x800	B225	250	300	250	970	2250	225	900	2442	280	6	1265	680	1350	450	670	950	890	28	6	2616
NOLH 250-500	355M-L	315	1450	2250x800	B250	250	300	250	970	2250	225	900	2444	280	8	1265	680	1350	450	670	950	890	28	6	2826
NOLH 250-500	355L	355	1450	2250x800	B250	250	300	250	970	2250	225	900	2587	280	8	1165	680	1350	450	670	950	890	28	6	2868
NOLH 250-500	355J	400	1450	2500x800	B250	250	300	250	970	2500	250	1000	2757	305	8	1165	680	1350	450	670	950	890	28	6	3139
NOLH 300-400	225S-M	45	1450	1600x800	B140	300	350	300	1020	1600	270	1060	1871	390	4	733	565	1235	425	670	910	890	20	4	1193
NOLH 300-400	250S-M	55	1450	1800x800	B160	300	350	300	1020	1800	300	1200	1949	410	6	798	605	1275	425	670	930	890	25	4	1323
NOLH 300-400	280S-M	75	1450	1800x800	B180	300	350	300	1020	1800	300	1200	2062	410	6	923	605	1275	425	670	930	890	25	4	1611
NOLH 300-400	280S-M	90	1450	1800x800	B180	300	350	300	1020	1800	300	1200	2062	410	6	923	605	1275	425	670	930	890	25	4	1680
NOLH 300-400	315S-M	110	1450	2000x800	B200	300	350	300	1020	2000	350	1300	2182	460	6	997	615	1285	425	670	930	890	25	4	1775
NOLH 300-400	315S-M	132	1450	2000x800	B200	300	350	300	1020	2000	350	1300	2182	460	6	997	615	1285	425	670	930	890	25	4	1924
NOLH 300-400	315S-M	160	1450	2000x800	B200	300	350	300	1020	2000	350	1300	2182	460	6	997	615	1285	425	670	930	890	25	4	1924
NOLH 300-400	315B	200	1450	2250x800	B200	300	350	300	1020	2250	225	900	2596	325	6	1135	655	1325	425	670	950	890	28	6	2257
NOLH 300-400	355M-L	250	1450	2250x800	B225	300	350	300	1020	2250	225	900	2492	325	6	1265	655	1325	425	670	950	890	28	6	2648
NOLH 300-400	355M-L	315	1450	2250x800	B250	300	350	300	1020	2250	225	900	2494	325	8	1265	655	1325	425	670	950	890	28	6	2858
NOLH 300-400	355L	355	1450	2250x800	B250	300	350	300	1020	2250	225	900	2637	325	8	1165	655	1325	425	670	950	890	28	6	2899
NOLH 300-400	355J	400	1450	2500x800	B250	300	350	300	1020	2500	250	1000	2807	350	8	1165	655	1325	425	670	950	890	28	6	3171
NOLH 300-500	225S-M	45	1450	1800x900	B140	300	350	300	1020	1800	300	1200	1871	410	4	773	660	1330	480	670	1030	990	25	4	1435
NOLH 300-500	250S-M	55	1450	1800x900	B160	300	350	300	1020	1800	300	1200	1949	410	6	798	660	1330	480	670	1030	990	25	4	1518
NOLH 300-500	280S-M	75	1450	1800x900	B180	300	350	300	1020	1800	300	1200	2062	410	6	923	660	1330	480	670	1030	990	25	4	1806
NOLH 300-500	280S-M	90	1450	1800x900	B180	300	350	300	1020	1800	300	1200	2062	410	6	923	660	1330	480	670	1030	990	25	4	1875
NOLH 300-500	315S-M	110	1450	2000x900	B200	300	350	300	1020	2000	350	1300	2182	460	6	997	670	1340	480	670	1030	990	25	4	1969
NOLH 300-500	315S-M	132	1450	2000x900	B200	300	350	300	1020	2000	350	1300	2182	460	6	997	670	1340	480	670	1030	990	25	4	2119
NOLH 300-500	315S-M	160	1450	2000x900	B200	300	350	300	1020	2000	350	1300	2182	460	6	997	670	1340	480	670	1030	990	25	4	2119
NOLH 300-500	315B	200	1450	2250x900	B200	300	350	300	1020	2250	225	900	2596	325	6	1135	710	1380	480	670	1050	990	28	6	2455
NOLH 300-500	355M-L	250	1450	2250x900	B225	300	350	300	1020	2250	225	900	2492	325	6	1265	710	1380	480	670	1050	990	28	6	2845
NOLH 300-500	355M-L	315	1450	2250x900	B250	300	350	300	1020	2250	225	900	2494	325	8	1265	710	1380	480	670	1050	990	28	6	3056
NOLH 300-500	355L	355	1450	2250x900	B250	300	350	300	1020	2250	225	900	2637	325	8	1165	710	1380	480	670	1050	990	28	6	3097
NOLH 300-500	355J	400	1450	2500x900	B250	300	350	300	1020	2500	250	1000	2807	350	8	1165	710	1380	480	670	1050	990	28	6	3370
NOLH 300-500	355C	500	1450	2800x900	B280	300	350	300	1020	2800	280	1120	3108	380	8	1174	710	1380	480	670	1050	990	28	6	3784
NOLH 300-500	355D	560	1450	2800x900	B280	300	350	300	1020	2800	280	1120	3108	380	8	1174	710	1380	480	670	1050	990	28	6	4042
NOLH 300-500	400L	630	1450	2500x900	A315	300	350	300	1020	2500	250	1000	3128	350	8	1256	710	1380	480	670	1050	990	28	6	4897
NOLH 300-500	**	710	1450	**	**	300	350	300	1020	**	**	**	3128	**	10	**	**	**	480	670	**	**	**	**	**

* = C tes donnÉes ^ titre indicatif, ne pas utiliser ces valeurs pour rÉalisation. ** Nous consulter.

DIMENSIONS – GROUPES – 2900 MIN-1 AVEC SPACER

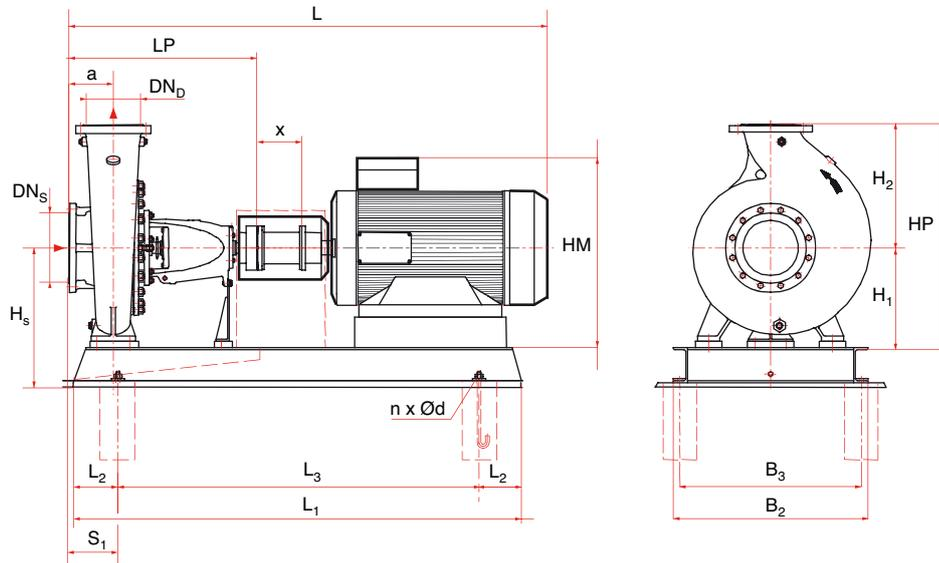

DIMENSIONS – GROUPES – 2900 MIN-1 AVEC SPACER

Type pompe	Type moteur	Puissance nom. moteur (P2h en kW)	Vitesse	châssis	Accouplement	DND	DNS	a	LP	L1*	L2*	L3*	L*	S1	x	HM	Hs*	HP	H1	H2	B2*	B3*	Ø d*	n*	Poids groupe
NOLH 032-125	71	0,55	2900	800 x 270 F	H80	32	50	80	440	840	150	540	788	160	100	192	195	335	190	140	360	320	19	4	89
NOLH 032-125	80	0,75	2900	800 x 270 F	H80	32	50	80	440	840	150	540	816	160	100	210	195	335	190	140	360	320	19	4	92
NOLH 032-125	80	1,1	2900	800 x 270 F	H80	32	50	80	440	840	150	540	816	160	100	210	195	335	190	140	360	320	19	4	93
NOLH 032-125	90S	1,5	2900	800 x 270 F	H80	32	50	80	440	840	150	540	844	160	100	240	195	335	190	140	360	320	19	4	98
NOLH 032-125	90L	2,2	2900	800 x 270 F	H80	32	50	80	440	840	150	540	869	160	100	240	195	335	190	140	360	320	19	4	101
NOLH 032-160	90S	1,5	2900	800 x 270 F	H80	32	50	80	440	840	150	540	844	160	100	240	215	375	240	190	360	320	19	4	101
NOLH 032-160	90L	2,2	2900	800 x 270 F	H80	32	50	80	440	840	150	540	869	160	100	240	215	375	240	190	360	320	19	4	103
NOLH 032-160	100L	3	2900	900 x 300 F	H80	32	50	80	440	940	170	600	916	180	100	260	215	375	240	190	390	350	19	4	123
NOLH 032-160	112M	4	2900	900 x 300 F	H80	32	50	80	440	940	170	600	916	180	100	260	215	375	240	190	390	350	19	4	134
NOLH 032-160	132S	5,5	2900	900 x 300 F	H80	32	50	80	440	940	170	600	992	180	100	339	215	375	240	190	390	350	19	4	154
NOLH 032-200	90L	2,2	2900	800 x 270 F	H80	32	50	80	440	840	150	540	869	160	100	240	243	423	240	190	360	320	19	4	104
NOLH 032-200	100L	3	2900	900 x 300 F	H80	32	50	80	440	940	170	600	916	180	100	260	243	423	240	190	390	350	19	4	124
NOLH 032-200	112M	4	2900	900 x 300 F	H80	32	50	80	440	940	170	600	916	180	100	260	243	423	240	190	390	350	19	4	135
NOLH 032-200	132S	5,5	2900	900 x 300 F	H95	32	50	80	440	940	170	600	992	180	100	339	243	423	240	190	390	350	19	4	156
NOLH 032-200	132S	7,5	2900	900 x 300 F	H95	32	50	80	440	940	170	600	992	180	100	339	243	423	240	190	390	350	19	4	162
NOLH 032-200	132M	9	2900	1120 x 380 F	H95	32	50	80	440	1160	210	740	1030	220	100	339	263	443	240	190	490	440	24	4	215
NOLH 032-200	160M	11	2900	1120 x 380 F	H95	32	50	80	440	1160	210	740	1138	220	100	410	263	443	240	190	490	440	24	4	249
NOLH 032-250	132S	7,5	2900	1000 x 340 F	H95	32	50	100	460	1040	190	660	1012	207,5	100	339	283	508	320	250	450	400	24	4	187
NOLH 032-250	132M	9	2900	1000 x 340 F	H95	32	50	100	460	1040	190	660	1050	207,5	100	339	283	508	320	250	450	400	24	4	193
NOLH 032-250	160M	11	2900	1000 x 340 F	H95	32	50	100	460	1040	190	660	1158	207,5	100	410	283	508	320	250	450	400	24	4	227
NOLH 032-250	160M	15	2900	1000 x 340 F	H95	32	50	100	460	1040	190	660	1158	207,5	100	410	283	508	320	250	450	400	24	4	234

* = C tes données titre indicatif, ne pas utiliser ces valeurs pour réalisation.

NOLH

DIMENSIONS – GROUPES – 2900 MIN-1 AVEC SPACER

Type pompe	Type moteur	Puissance nom. moteur (P2h en kW)	Vitesse	châssis	Accouplement	DND	DNS	a	LP	L1*	L2*	L3*	L*	S1	x	HM	Hs*	HP	H1	H2	B2*	B3*	Ø d*	n*	Poids groupe
NOLH 040-125	80	1,1	2900	800 x 270 F	H80	40	65	80	440	840	150	540	816	160	100	210	195	335	210	160	360	320	19	4	90
NOLH 040-125	90S	1,5	2900	800 x 270 F	H80	40	65	80	440	840	150	540	844	160	100	240	195	335	210	160	360	320	19	4	95
NOLH 040-125	90L	2,2	2900	900 x 300 F	H80	40	65	80	440	940	170	600	869	180	100	240	195	335	210	160	390	350	19	4	108
NOLH 040-125	100L	3	2900	900 x 300 F	H80	40	65	80	440	940	170	600	916	180	100	260	195	335	210	160	390	350	19	4	117
NOLH 040-160	90S	1,5	2900	800 x 270 F	H80	40	65	80	440	840	150	540	844	160	100	240	215	375	240	190	360	320	19	4	97
NOLH 040-160	90L	2,2	2900	900 x 300 F	H80	40	65	80	440	940	170	600	869	180	100	240	215	375	240	190	390	350	19	4	110
NOLH 040-160	100L	3	2900	900 x 300 F	H80	40	65	80	440	940	170	600	916	180	100	260	215	375	240	190	390	350	19	4	119
NOLH 040-160	112M	4	2900	900 x 300 F	H80	40	65	80	440	940	170	600	916	180	100	260	215	375	240	190	390	350	19	4	131
NOLH 040-160	132S	5,5	2900	900 x 300 F	H95	40	65	80	440	940	170	600	992	180	100	339	215	375	240	190	390	350	19	4	152
NOLH 040-160	132S	7,5	2900	900 x 300 F	H95	40	65	80	440	940	170	600	992	180	100	339	215	375	240	190	390	350	19	4	158
NOLH 040-200	100L	3	2900	900 x 300 F	H80	40	65	100	460	940	170	600	936	200	100	260	243	423	265	212	390	350	19	4	126
NOLH 040-200	112M	4	2900	900 x 300 F	H80	40	65	100	460	940	170	600	936	200	100	260	243	423	265	212	390	350	19	4	137
NOLH 040-200	132S	5,5	2900	900 x 300 F	H95	40	65	100	460	940	170	600	1012	200	100	339	243	423	265	212	390	350	19	4	158
NOLH 040-200	132S	7,5	2900	900 x 300 F	H95	40	65	100	460	940	170	600	1012	200	100	339	243	423	265	212	390	350	19	4	164
NOLH 040-200	132M	9	2900	1120 x 380 F	H95	40	65	100	460	1160	210	740	1050	240	100	339	263	443	265	212	490	440	24	4	217
NOLH 040-200	160M	11	2900	1000 x 340 F	H95	40	65	100	460	1040	190	660	1158	220	100	410	263	443	265	212	450	400	24	4	216
NOLH 040-200	160M	15	2900	1000 x 340 F	H95	40	65	100	460	1040	190	660	1158	220	100	410	263	443	265	212	450	400	24	4	224
NOLH 040-250	132S	7,5	2900	1000 x 340 F	H95	40	65	100	460	1040	190	660	1012	207,5	100	339	283	508	320	250	450	400	24	4	187
NOLH 040-250	132M	9	2900	1000 x 340 F	H95	40	65	100	460	1040	190	660	1050	207,5	100	339	283	508	320	250	450	400	24	4	193
NOLH 040-250	160M	11	2900	1000 x 340 F	H95	40	65	100	460	1040	190	660	1158	207,5	100	410	283	508	320	250	450	400	24	4	227
NOLH 040-250	160M	15	2900	1000 x 340 F	H95	40	65	100	460	1040	190	660	1158	207,5	100	410	283	508	320	250	450	400	24	4	234
NOLH 040-250	160L	18,5	2900	1120 x 380 F	H95	40	65	100	460	1160	210	740	1202	227,5	100	410	283	508	320	250	490	440	24	4	284
NOLH 040-315	160M	11	2900	1120 x 380 F	H95	40	65	125	595	1160	210	740	1293	252,5	100	410	328	578	345	280	490	440	24	4	290
NOLH 040-315	160M	15	2900	1120 x 380 F	H95	40	65	125	595	1160	210	740	1293	252,5	100	410	328	578	345	280	490	440	24	4	297
NOLH 040-315	160L	18,5	2900	1250 x 430 F	H95	40	65	125	595	1310	235	840	1337	277,5	100	410	328	578	345	280	540	490	24	4	344
NOLH 040-315	180M	22	2900	1250 x 430 F	H110	40	65	125	595	1310	235	840	1359	277,5	100	450	328	578	345	280	540	490	24	4	395
NOLH 040-315	200L	30	2900	1250 x 430 F	H125	40	65	125	595	1310	235	840	1462	277,5	100	494	328	578	345	280	540	490	24	4	468
NOLH 040-315	200L	37	2900	1250 x 430 F	H125	40	65	125	595	1310	235	840	1462	277,5	100	494	328	578	345	280	540	490	24	4	483
NOLH 050-125	90S	1,5	2900	800 x 270 F	H80	50	65	100	460	840	150	540	864	180	100	240	215	375	240	190	360	320	19	4	97
NOLH 050-125	90L	2,2	2900	900 x 300 F	H80	50	65	100	460	940	170	600	889	200	100	240	215	375	240	190	390	350	19	4	110
NOLH 050-125	100L	3	2900	900 x 300 F	H80	50	65	100	460	940	170	600	936	200	100	260	215	375	240	190	390	350	19	4	119
NOLH 050-125	112M	4	2900	900 x 300 F	H80	50	65	100	460	940	170	600	936	200	100	260	215	375	240	190	390	350	19	4	131
NOLH 050-125	132S	5,5	2900	900 x 300 F	H95	50	65	100	460	940	170	600	1012	200	100	339	215	375	240	190	390	350	19	4	152
NOLH 050-160	90L	2,2	2900	900 x 300 F	H80	50	65	100	460	940	170	600	889	200	100	240	243	423	265	212	390	350	19	4	116
NOLH 050-160	100L	3	2900	900 x 300 F	H80	50	65	100	460	940	170	600	936	200	100	260	243	423	265	212	390	350	19	4	126
NOLH 050-160	112M	4	2900	900 x 300 F	H80	50	65	100	460	940	170	600	936	200	100	260	243	423	265	212	390	350	19	4	137
NOLH 050-160	132S	5,5	2900	900 x 300 F	H95	50	65	100	460	940	170	600	1012	200	100	339	243	423	265	212	390	350	19	4	158
NOLH 050-160	132S	7,5	2900	900 x 300 F	H95	50	65	100	460	940	170	600	1012	200	100	339	243	423	265	212	390	350	19	4	164
NOLH 050-160	132M	9	2900	1120 x 380 F	H95	50	65	100	460	1160	210	740	1050	240	100	339	263	443	265	212	490	440	24	4	217
NOLH 050-160	160M	11	2900	1000 x 340 F	H95	50	65	100	460	1040	190	660	1158	220	100	410	263	443	265	212	450	400	24	4	216

* = C tes donnÉes ^ titre indicatif, ne pas utiliser ces valeurs pour rÉalisation.

DIMENSIONS – GROUPES – 2900 MIN-1 AVEC SPACER

Type pompe	Type moteur	Puissance nom. moteur (P2n en kW)	Vitesse	châssis	Accouplement	DND	DNS	a	LP	L1*	L2*	L3*	L*	S1	x	HM	Hs*	HP	H1	H2	B2*	B3*	Ø d*	r*	Poids groupe
NOLH 050-200	100L	3	2900	900 x 300 F	H80	50	65	100	460	940	170	600	936	200	100	260	243	443	265	212	390	350	19	4	130
NOLH 050-200	112M	4	2900	900 x 300 F	H80	50	65	100	460	940	170	600	936	200	100	260	243	443	265	212	390	350	19	4	141
NOLH 050-200	132S	5,5	2900	900 x 300 F	H95	50	65	100	460	940	170	600	1012	200	100	339	243	443	265	212	390	350	19	4	162
NOLH 050-200	132S	7,5	2900	900 x 300 F	H95	50	65	100	460	940	170	600	1012	200	100	339	243	443	265	212	390	350	19	4	168
NOLH 050-200	132M	9	2900	1120 x 380 F	H95	50	65	100	460	1160	210	740	1050	240	100	339	263	463	265	212	490	440	24	4	221
NOLH 050-200	160M	11	2900	1000 x 340 F	H95	50	65	100	460	1040	190	660	1158	220	100	410	263	463	265	212	450	400	24	4	220
NOLH 050-200	160M	15	2900	1000 x 340 F	H95	50	65	100	460	1040	190	660	1158	220	100	410	263	463	265	212	450	400	24	4	228
NOLH 050-200	160L	18,5	2900	1120 x 380 F	H95	50	65	100	460	1160	210	740	1202	240	100	410	263	463	265	212	490	440	24	4	278
NOLH 050-250	160M	15	2900	1000 x 340 F	H95	50	65	100	460	1040	190	660	1158	207,5	100	410	283	508	320	250	450	400	24	4	238
NOLH 050-250	160L	18,5	2900	1120 x 380 F	H95	50	65	100	460	1160	210	740	1202	227,5	100	410	283	508	320	250	490	440	24	4	289
NOLH 050-250	180M	22	2900	1120 x 380 F	H110	50	65	100	460	1160	210	740	1224	227,5	100	450	283	508	320	250	490	440	24	4	339
NOLH 050-250	200L	30	2900	1250 x 430 F	H125	50	65	100	460	1310	235	840	1327	252,5	100	494	303	528	320	250	540	490	24	4	444
NOLH 050-315	160M	15	2900	1120 x 380 F	H95	50	65	125	595	1160	210	740	1293	252,5	100	410	328	608	345	280	490	440	24	4	313
NOLH 050-315	160L	18,5	2900	1250 x 430 F	H95	50	65	125	595	1310	235	840	1337	277,5	100	410	328	608	345	280	540	490	24	4	360
NOLH 050-315	180M	22	2900	1250 x 430 F	H110	50	65	125	595	1310	235	840	1359	277,5	100	450	328	608	345	280	540	490	24	4	410
NOLH 050-315	200L	30	2900	1400 x 480 F	H125	50	65	125	595	1460	260	940	1462	302,5	100	494	328	608	345	280	610	550	29	4	531
NOLH 050-315	200L	37	2900	1400 x 480 F	H125	50	65	125	595	1460	260	940	1462	302,5	100	494	328	608	345	280	610	550	29	4	546
NOLH 050-315	225S-M	45	2900	1400 x 480 F	H125	50	65	125	595	1460	260	940	1512	302,5	100	593	328	608	345	280	610	550	29	4	712
NOLH 050-315	250S-M	55	2900	1600 x 530 F	H140	50	65	125	595	1660	300	1060	1618	342,5	100	618	373	653	345	280	660	600	29	4	839
NOLH 050-315	280S-M	75	2900	1800 x 600 F	H160	50	65	125	595	1860	330	1200	1731	372,5	100	743	403	683	345	280	730	670	29	4	1111
NOLH 065-125	100L	3	2900	900 x 300 F	H80	65	80	100	460	940	170	600	936	187,5	100	260	243	423	280	212	390	350	19	4	123
NOLH 065-125	112M	4	2900	900 x 300 F	H80	65	80	100	460	940	170	600	936	187,5	100	260	243	423	280	212	390	350	19	4	134
NOLH 065-125	132S	5,5	2900	1000 x 340 F	H95	65	80	100	460	1040	190	660	1012	207,5	100	339	263	443	280	212	450	400	24	4	167
NOLH 065-125	132S	7,5	2900	1000 x 340 F	H95	65	80	100	460	1040	190	660	1012	207,5	100	339	263	443	280	212	450	400	24	4	174
NOLH 065-160	132S	5,5	2900	1000 x 340 F	H95	65	80	100	460	940	170	600	1012	187,5	100	339	243	443	280	212	390	350	24	4	161
NOLH 065-160	132S	7,5	2900	1000 x 340 F	H95	65	80	100	460	940	170	600	1012	187,5	100	339	243	443	280	212	390	350	24	4	167
NOLH 065-160	132M	9	2900	1000 x 340 F	H95	65	80	100	460	1040	190	660	1050	207,5	100	339	263	463	280	212	450	400	24	4	186
NOLH 065-160	160M	11	2900	1000 x 340 F	H95	65	80	100	460	1040	190	660	1158	207,5	100	410	263	463	280	212	450	400	24	4	219
NOLH 065-160	160M	15	2900	1000 x 340 F	H95	65	80	100	460	1040	190	660	1158	207,5	100	410	263	463	280	212	450	400	24	4	227
NOLH 065-200	132M	9	2900	1000 x 340 F	H95	65	80	100	460	1040	190	660	1090	207,5	140	339	283	508	320	250	450	400	24	4	192
NOLH 065-200	160M	11	2900	1120 x 380 F	H95	65	80	100	460	1160	210	740	1198	227,5	140	410	283	508	320	250	490	440	24	4	261
NOLH 065-200	160M	15	2900	1120 x 380 F	H95	65	80	100	460	1160	210	740	1198	227,5	140	410	283	508	320	250	490	440	24	4	268
NOLH 065-200	160L	18,5	2900	1120 x 380 F	H95	65	80	100	460	1160	210	740	1242	227,5	140	410	283	508	320	250	490	440	24	4	284
NOLH 065-200	180M	22	2900	1250 x 430 F	H110	65	80	100	460	1310	235	840	1264	252,5	140	450	283	508	320	250	540	490	24	4	366
NOLH 065-200	200L	30	2900	1250 x 430 F	H125	65	80	100	460	1310	235	840	1367	252,5	140	494	303	528	320	250	540	490	24	4	439
NOLH 065-250	160L	18,5	2900	1400 x 480 F	H95	65	80	100	570	1460	260	940	1352	260	140	410	303	553	360	280	610	550	29	4	389
NOLH 065-250	180M	22	2900	1250 x 430 F	H110	65	80	100	570	1310	235	840	1374	235	140	450	303	553	360	280	540	490	24	4	392
NOLH 065-250	200L	30	2900	1400 x 480 F	H125	65	80	100	570	1460	260	940	1477	260	140	494	303	553	360	280	610	550	29	4	512
NOLH 065-250	200L	37	2900	1400 x 480 F	H125	65	80	100	570	1460	260	940	1477	260	140	494	303	553	360	280	610	550	29	4	527

* = C tes données ^ titre indicatif, ne pas utiliser ces valeurs pour ralisation.

NOLH

DIMENSIONS – GROUPES – 2900 MIN-1 AVEC SPACER

Type pompe	Type moteur	Puissance nom. moteur (P2h en kW)	Vitesse	châssis	Accouplement	DND	DNS	a	LP	L1*	L2*	L3*	L*	S1	x	HM	Hs*	HP	H1	H2	B2*	B3*	Ø d*	n*	Poids groupe	
NOLH 065-250	225S-M	45	2900	1400 x 480	F	H125	65	80	100	570	1460	260	940	1527	260	140	593	328	578	360	280	610	550	29	4	693
NOLH 080-160	132S	7,5	2900	1000 x 340	F	H95	80	100	125	485	1040	190	660	1077	232,5	140	339	283	508	320	250	450	400	24	4	184
NOLH 080-160	132M	9	2900	1000 x 340	F	H95	80	100	125	485	1040	190	660	1115	232,5	140	339	283	508	320	250	450	400	24	4	190
NOLH 080-160	160M	11	2900	1120 x 380	F	H95	80	100	125	485	1160	210	740	1223	252,5	140	410	283	508	320	250	490	440	24	4	259
NOLH 080-160	160M	15	2900	1120 x 380	F	H95	80	100	125	485	1160	210	740	1223	252,5	140	410	283	508	320	250	490	440	24	4	266
NOLH 080-160	160L	18,5	2900	1120 x 380	F	H95	80	100	125	485	1160	210	740	1267	252,5	140	410	283	508	320	250	490	440	24	4	282
NOLH 080-160	180M	22	2900	1250 x 430	F	H110	80	100	125	485	1310	235	840	1289	277,5	140	450	283	508	320	250	540	490	24	4	364
NOLH 080-200	160M	15	2900	1250 x 430	F	H95	80	100	125	595	1310	235	840	1333	334	140	410	283	533	345	280	540	490	24	4	315
NOLH 080-200	160L	18,5	2900	1250 x 430	F	H95	80	100	125	595	1310	235	840	1377	334	140	410	283	533	345	280	540	490	24	4	331
NOLH 080-200	180M	22	2900	1250 x 430	F	H110	80	100	125	595	1310	235	840	1399	334	140	450	283	533	345	280	540	490	24	4	381
NOLH 080-200	200L	30	2900	1250 x 430	F	H125	80	100	125	595	1310	235	840	1502	334	140	494	303	553	345	280	540	490	24	4	454
NOLH 080-200	200L	37	2900	1250 x 430	F	H125	80	100	125	595	1310	235	840	1502	334	140	494	303	553	345	280	540	490	24	4	469
NOLH 080-200	225S-M	45	2900	1400 x 480	F	H125	80	100	125	595	1460	260	940	1552	359	140	593	328	578	345	280	610	550	29	4	682
NOLH 080-250	180M	22	2900	1250 x 430	F	H110	80	100	125	595	1310	235	840	1399	260	140	450	303	583	400	315	540	490	24	4	397
NOLH 080-250	200L	30	2900	1400 x 480	F	H125	80	100	125	595	1460	260	940	1502	285	140	494	303	583	400	315	610	550	29	4	517
NOLH 080-250	200L	37	2900	1400 x 480	F	H125	80	100	125	595	1460	260	940	1502	285	140	494	303	583	400	315	610	550	29	4	532
NOLH 080-250	225S-M	45	2900	1400 x 480	F	H125	80	100	125	595	1460	260	940	1552	285	140	593	328	608	400	315	610	550	29	4	698
NOLH 080-250	250S-M	55	2900	1600 x 530	F	H140	80	100	125	595	1660	300	1060	1658	325	140	618	373	653	400	315	660	600	29	4	825
NOLH 100-160	160L	18,5	2900	1400 x 480	F	H95	100	125	125	595	1460	260	940	1377	285	140	410	303	583	360	280	610	550	29	4	397
NOLH 100-160	180M	22	2900	1250 x 430	F	H110	100	125	125	595	1310	235	840	1399	260	140	450	303	583	360	280	540	490	24	4	400
NOLH 100-160	200L	30	2900	1400 x 480	F	H125	100	125	125	595	1460	260	940	1502	285	140	494	303	583	360	280	610	550	29	4	520
NOLH 100-160	200L	37	2900	1400 x 480	F	H125	100	125	125	595	1460	260	940	1502	285	140	494	303	583	360	280	610	550	29	4	535
NOLH 100-200	160L	18,5	2900	1400 x 480	F	H95	100	125	125	595	1460	260	940	1377	285	140	410	303	583	360	280	610	550	29	4	389
NOLH 100-200	180M	22	2900	1250 x 430	F	H110	100	125	125	595	1310	235	840	1399	260	140	450	303	583	360	280	540	490	24	4	392
NOLH 100-200	200L	30	2900	1400 x 480	F	H125	100	125	125	595	1460	260	940	1502	285	140	494	303	583	360	280	610	550	29	4	512
NOLH 100-200	200L	37	2900	1400 x 480	F	H125	100	125	125	595	1460	260	940	1502	285	140	494	303	583	360	280	610	550	29	4	527
NOLH 100-200	225S-M	45	2900	1400 x 480	F	H125	100	125	125	595	1460	260	940	1552	285	140	593	328	608	360	280	610	550	29	4	693
NOLH 100-250	200L	30	2900	1400 x 480	F	H125	100	125	140	610	1460	260	940	1517	300	140	494	328	608	400	315	610	550	29	4	528
NOLH 100-250	200L	37	2900	1400 x 480	F	H125	100	125	140	610	1460	260	940	1517	300	140	494	328	608	400	315	610	550	29	4	543
NOLH 100-250	225S-M	45	2900	1400 x 480	F	H125	100	125	140	610	1460	260	940	1567	300	140	593	328	608	400	315	610	550	29	4	708
NOLH 100-250	250S-M	55	2900	1600 x 530	F	H140	100	125	140	610	1660	300	1060	1673	340	140	618	373	653	400	315	660	600	29	4	836
NOLH 100-250	280S-M	75	2900	1800 x 600	F	H160	100	125	140	610	1860	330	1200	1786	370	140	743	403	683	400	315	730	670	29	4	1108
NOLH 100-250	280S-M	90	2900	1800 x 600	F	H160	100	125	140	610	1860	330	1200	1786	370	140	743	403	683	400	315	730	670	29	4	1160
NOLH 125-200	250S-M	55	2900	1600 x 530	F	H140	125	150	140	610	1660	300	1060	1673	340	140	618	373	688	400	315	660	600	29	4	851
NOLH 125-200	280S-M	75	2900	1800 x 600	F	H160	125	150	140	610	1860	330	1200	1786	370	140	743	403	718	400	315	730	670	29	4	1124
NOLH 125-200	280S-M	90	2900	1800 x 600	F	H160	125	150	140	610	1860	330	1200	1786	370	140	743	403	718	400	315	730	670	29	4	1176
NOLH 125-200	315S-M	110	2900	2100 x 740	F	H160	125	150	140	610	2140	370	1400	1876	410	140	807	438	753	400	315	860	790	29	4	1353

* = C tes données ^ titre indicatif, ne pas utiliser ces valeurs pour réalisation.

DIMENSIONS – GROUPES – 2900 MIN-1 SANS SPACER

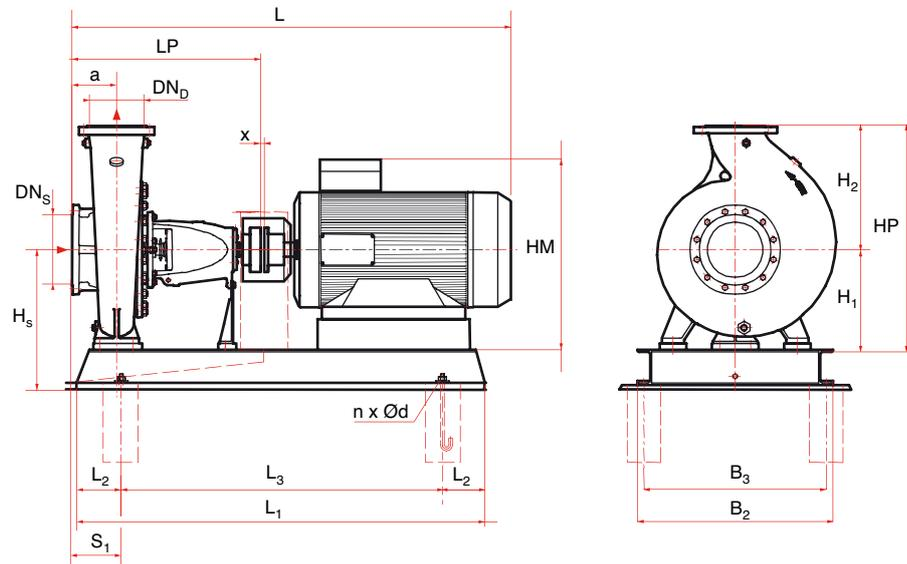

DIMENSIONS – GROUPES – 2900 MIN-1 SANS SPACER

Type pompe	Type moteur	Puissance nom. moteur (P2n en kW)	Vitesse	châssis	Accouplement	DND	DNS	a	LP	L1*	L2*	L3*	L*	S1	x	HM	Hs*	HP	H1	H2	B2*	B3*	Ø d*	n*	Poids groupe
NOLH 032-125	71	0,55	2900	800 x 270 F	B80	32	50	80	440	840	150	540	692	160	4	192	112	335	112	140	360	320	19	4	87
NOLH 032-125	80	0,75	2900	800 x 270 F	B80	32	50	80	440	840	150	540	720	160	4	210	112	335	112	140	360	320	19	4	91
NOLH 032-125	80	1,1	2900	800 x 270 F	B80	32	50	80	440	840	150	540	720	160	4	210	112	335	112	140	360	320	19	4	91
NOLH 032-125	90S	1,5	2900	800 x 270 F	B80	32	50	80	440	840	150	540	748	160	4	240	112	335	112	140	360	320	19	4	97
NOLH 032-125	90L	2,2	2900	800 x 270 F	B80	32	50	80	440	840	150	540	773	160	4	240	112	335	112	140	360	320	19	4	99
NOLH 032-160	90S	1,5	2900	800 x 270 F	B80	32	50	80	440	840	150	540	748	160	4	240	132	375	132	160	360	320	19	4	99
NOLH 032-160	90L	2,2	2900	800 x 270 F	B80	32	50	80	440	840	150	540	773	160	4	240	132	375	132	160	360	320	19	4	101
NOLH 032-160	100L	3	2900	800 x 270 F	B80	32	50	80	440	840	150	540	820	160	4	260	132	375	132	160	360	320	19	4	111
NOLH 032-160	112M	4	2900	800 x 270 F	B80	32	50	80	440	840	150	540	820	160	4	260	132	375	132	160	360	320	19	4	122
NOLH 032-160	132S	5,5	2900	800 x 270 F	B95	32	50	80	440	840	150	540	896	160	4	339	132	375	132	160	360	320	19	4	143
NOLH 032-200	90L	2,2	2900	800 x 270 F	B80	32	50	80	440	840	150	540	773	160	4	240	160	423	160	180	360	320	19	4	102
NOLH 032-200	100L	3	2900	800 x 270 F	B80	32	50	80	440	840	150	540	820	160	4	260	160	423	160	180	360	320	19	4	112
NOLH 032-200	112M	4	2900	800 x 270 F	B80	32	50	80	440	840	150	540	820	160	4	260	160	423	160	180	360	320	19	4	123
NOLH 032-200	132S	5,5	2900	800 x 270 F	B95	32	50	80	440	840	150	540	896	160	4	339	160	423	160	180	360	320	19	4	144
NOLH 032-200	132S	7,5	2900	800 x 270 F	B95	32	50	80	440	840	150	540	896	160	4	339	160	423	160	180	360	320	19	4	150
NOLH 032-200	132M	9	2900	800 x 270 F	B95	32	50	80	440	840	150	540	934	160	4	339	160	423	160	180	360	320	19	4	156
NOLH 032-250	132S	7,5	2900	1000 x 340 F	B95	32	50	100	460	1040	190	660	916	207,5	4	339	180	508	180	225	450	400	24	4	186
NOLH 032-250	132M	9	2900	1000 x 340 F	B95	32	50	100	460	1040	190	660	954	207,5	4	339	180	508	180	225	450	400	24	4	192
NOLH 032-250	160M	11	2900	1000 x 340 F	B95	32	50	100	460	1040	190	660	1062	207,5	4	410	180	508	180	225	450	400	24	4	225
NOLH 032-250	160M	15	2900	1000 x 340 F	B95	32	50	100	460	1040	190	660	1062	207,5	4	410	180	508	180	225	450	400	24	4	233
NOLH 040-125	80	1,1	2900	800 x 270 F	B80	40	65	80	440	840	150	540	720	160	4	210	112	335	112	140	360	320	19	4	88

* = C tes données titre indicatif, ne pas utiliser ces valeurs pour réalisation.

NOLH

DIMENSIONS – GROUPES – 2900 MIN-1 SANS SPACER

Type pompe	Type moteur	Puissance nom. moteur (P2n en kW)	Vitesse	châssis	Accouplement	DND	DNS	a	LP	L1*	L2*	L3*	L*	S1	x	HM	Hs*	HP	H1	H2	B2*	B3*	Ø d*	n*	Poids groupe
NOLH 040-125	90S	1,5	2900	800 x 270 F	B80	40	65	80	440	840	150	540	748	160	4	240	112	335	112	140	360	320	19	4	94
NOLH 040-125	90L	2,2	2900	800 x 270 F	B80	40	65	80	440	840	150	540	773	160	4	240	112	335	112	140	360	320	19	4	96
NOLH 040-125	100L	3	2900	800 x 270 F	B80	40	65	80	440	840	150	540	820	160	4	260	112	335	112	140	360	320	19	4	106
NOLH 040-160	90S	1,5	2900	800 x 270 F	B80	40	65	80	440	840	150	540	748	160	4	240	132	375	132	160	360	320	19	4	96
NOLH 040-160	90L	2,2	2900	800 x 270 F	B80	40	65	80	440	840	150	540	773	160	4	240	132	375	132	160	360	320	19	4	98
NOLH 040-160	100L	3	2900	800 x 270 F	B80	40	65	80	440	840	150	540	820	160	4	260	132	375	132	160	360	320	19	4	108
NOLH 040-160	112M	4	2900	800 x 270 F	B80	40	65	80	440	840	150	540	820	160	4	260	132	375	132	160	360	320	19	4	119
NOLH 040-160	132S	5,5	2900	900 x 300 F	B95	40	65	80	440	940	170	600	896	180	4	339	132	375	132	160	390	350	19	4	150
NOLH 040-160	132S	7,5	2900	900 x 300 F	B95	40	65	80	440	940	170	600	896	180	4	339	132	375	132	160	390	350	19	4	157
NOLH 040-200	100L	3	2900	800 x 270 F	B80	40	65	100	460	840	150	540	840	180	4	260	160	423	160	180	360	320	19	4	114
NOLH 040-200	112M	4	2900	800 x 270 F	B80	40	65	100	460	840	150	540	840	180	4	260	160	423	160	180	360	320	19	4	125
NOLH 040-200	132S	5,5	2900	900 x 300 F	B95	40	65	100	460	940	170	600	916	200	4	339	160	423	160	180	390	350	19	4	157
NOLH 040-200	132S	7,5	2900	900 x 300 F	B95	40	65	100	460	940	170	600	916	200	4	339	160	423	160	180	390	350	19	4	163
NOLH 040-200	132M	9	2900	900 x 300 F	B95	40	65	100	460	940	170	600	954	200	4	339	160	423	160	180	390	350	19	4	169
NOLH 040-200	160M	11	2900	1000 x 340 F	B95	40	65	100	460	1040	190	660	1062	220	4	410	160	443	160	180	450	400	24	4	215
NOLH 040-200	160M	15	2900	1000 x 340 F	B95	40	65	100	460	1040	190	660	1062	220	4	410	160	443	160	180	450	400	24	4	222
NOLH 040-250	132S	7,5	2900	1000 x 340 F	B95	40	65	100	460	1040	190	660	916	207,5	4	339	180	508	180	225	450	400	24	4	186
NOLH 040-250	132M	9	2900	1000 x 340 F	B95	40	65	100	460	1040	190	660	954	207,5	4	339	180	508	180	225	450	400	24	4	192
NOLH 040-250	160M	11	2900	1000 x 340 F	B95	40	65	100	460	1040	190	660	1062	207,5	4	410	180	508	180	225	450	400	24	4	225
NOLH 040-250	160M	15	2900	1000 x 340 F	B95	40	65	100	460	1040	190	660	1062	207,5	4	410	180	508	180	225	450	400	24	4	233
NOLH 040-250	160L	18,5	2900	1000 x 340 F	B95	40	65	100	460	1040	190	660	1106	207,5	4	410	180	508	180	225	450	400	24	4	248
NOLH 040-315	160M	11	2900	1120 x 380 F	B95	40	65	125	595	1160	210	740	1197	252,5	4	410	225	578	225	250	490	440	24	4	288
NOLH 040-315	160M	15	2900	1120 x 380 F	B95	40	65	125	595	1160	210	740	1197	252,5	4	410	225	578	225	250	490	440	24	4	296
NOLH 040-315	160L	18,5	2900	1120 x 380 F	B95	40	65	125	595	1160	210	740	1241	252,5	4	410	225	578	225	250	490	440	24	4	311
NOLH 040-315	180M	22	2900	1120 x 380 F	B110	40	65	125	595	1160	210	740	1263	252,5	4	450	225	578	225	250	490	440	24	4	361
NOLH 040-315	200L	30	2900	1250 x 430 F	B125	40	65	125	595	1310	235	840	1366	277,5	4	494	225	578	225	250	540	490	24	4	465
NOLH 040-315	200L	37	2900	1250 x 430 F	B125	40	65	125	595	1310	235	840	1366	277,5	4	494	225	578	225	250	540	490	24	4	480
NOLH 050-125	90S	1,5	2900	800 x 270 F	B80	50	65	100	460	840	150	540	768	180	4	240	132	375	132	160	360	320	19	4	96
NOLH 050-125	90L	2,2	2900	800 x 270 F	B80	50	65	100	460	840	150	540	793	180	4	240	132	375	132	160	360	320	19	4	98
NOLH 050-125	112M	4	2900	800 x 270 F	B80	50	65	100	460	840	150	540	840	180	4	260	132	375	132	160	360	320	19	4	119
NOLH 050-125	132S	5,5	2900	900 x 300 F	B95	50	65	100	460	940	170	600	916	200	4	339	132	375	132	160	390	350	19	4	150
NOLH 050-160	90L	2,2	2900	800 x 270 F	B80	50	65	100	460	840	150	540	793	180	4	240	160	423	160	180	360	320	19	4	105
NOLH 050-160	100L	3	2900	800 x 270 F	B80	50	65	100	460	840	150	540	840	180	4	260	160	423	160	180	360	320	19	4	114
NOLH 050-160	112M	4	2900	800 x 270 F	B80	50	65	100	460	840	150	540	840	180	4	260	160	423	160	180	360	320	19	4	125
NOLH 050-160	132S	5,5	2900	900 x 300 F	B95	50	65	100	460	940	170	600	916	200	4	339	160	423	160	180	390	350	19	4	157
NOLH 050-160	132S	7,5	2900	900 x 300 F	B95	50	65	100	460	940	170	600	916	200	4	339	160	423	160	180	390	350	19	4	163
NOLH 050-160	132M	9	2900	900 x 300 F	B95	50	65	100	460	940	170	600	954	200	4	339	160	423	160	180	390	350	19	4	169
NOLH 050-160	160M	11	2900	1000 x 340 F	B95	50	65	100	460	1040	190	660	1062	220	4	410	160	443	160	180	450	400	24	4	215

* = C tes donnÉes ^ titre indicatif, ne pas utiliser ces valeurs pour rÉalisation.

DIMENSIONS – GROUPES – 2900 MIN-1 SANS SPACER

Type pompe	Type moteur	Puissance nom. moteur (P2n en kW)	Vitesse	châssis	Accouplement	DND	DNS	a	LP	L1*	L2*	L3*	L*	S1	x	HM	Hs*	HP	H1	H2	B2*	B3*	Ø d*	n*	Poids groupe
NOLH 050-200	100L	3	2900	800 x 270 F	B80	50	65	100	460	840	150	540	840	180	4	260	160	443	160	200	360	320	19	4	118
NOLH 050-200	112M	4	2900	800 x 270 F	B80	50	65	100	460	840	150	540	840	180	4	260	160	443	160	200	360	320	19	4	129
NOLH 050-200	132S	5,5	2900	900 x 300 F	B95	50	65	100	460	940	170	600	916	200	4	339	160	443	160	200	390	350	19	4	161
NOLH 050-200	132S	7,5	2900	900 x 300 F	B95	50	65	100	460	940	170	600	916	200	4	339	160	443	160	200	390	350	19	4	167
NOLH 050-200	132M	9	2900	900 x 300 F	B95	50	65	100	460	940	170	600	954	200	4	339	160	443	160	200	390	350	19	4	173
NOLH 050-200	160M	11	2900	1000 x 340 F	B95	50	65	100	460	1040	190	660	1062	220	4	410	160	463	160	200	450	400	24	4	219
NOLH 050-200	160M	15	2900	1000 x 340 F	B95	50	65	100	460	1040	190	660	1062	220	4	410	160	463	160	200	450	400	24	4	226
NOLH 050-200	160L	18,5	2900	1000 x 340 F	B95	50	65	100	460	1040	190	660	1106	220	4	410	160	463	160	200	450	400	24	4	242
NOLH 050-250	160M	15	2900	1000 x 340 F	B95	50	65	100	460	1040	190	660	1062	207,5	4	410	180	508	180	225	450	400	24	4	237
NOLH 050-250	160L	18,5	2900	1000 x 340 F	B95	50	65	100	460	1040	190	660	1106	207,5	4	410	180	508	180	225	450	400	24	4	253
NOLH 050-250	180M	22	2900	1120 x 380 F	B110	50	65	100	460	1160	210	740	1128	227,5	4	450	180	508	180	225	490	440	24	4	337
NOLH 050-250	200L	30	2900	1250 x 430 F	B125	50	65	100	460	1310	235	840	1231	252,5	4	494	180	508	180	225	540	490	24	4	441
NOLH 050-315	160M	15	2900	1120 x 380 F	B95	50	65	125	595	1160	210	740	1197	252,5	4	410	225	608	225	280	490	440	24	4	311
NOLH 050-315	160L	18,5	2900	1120 x 380 F	B95	50	65	125	595	1160	210	740	1241	252,5	4	410	225	608	225	280	490	440	24	4	327
NOLH 050-315	180M	22	2900	1120 x 380 F	B110	50	65	125	595	1160	210	740	1263	252,5	4	450	225	608	225	280	490	440	24	4	377
NOLH 050-315	200L	30	2900	1250 x 430 F	B125	50	65	125	595	1310	235	840	1366	277,5	4	494	225	608	225	280	540	490	24	4	481
NOLH 050-315	200L	37	2900	1250 x 430 F	B125	50	65	125	595	1310	235	840	1366	277,5	4	494	225	608	225	280	540	490	24	4	496
NOLH 050-315	225S-M	45	2900	1400 x 480 F	B125	50	65	125	595	1460	260	940	1416	302,5	4	593	225	608	225	280	610	550	29	4	709
NOLH 050-315	250S-M	55	2900	1600 x 530 F	B140	50	65	125	595	1660	300	1060	1522	342,5	4	618	225	628	225	280	660	600	29	4	834
NOLH 050-315	280S-M	75	2900	1800 x 600 F	B160	50	65	125	595	1860	330	1200	1637	372,5	6	743	225	628	225	280	730	670	29	4	1105
NOLH 065-125	100L	3	2900	900 x 300 F	B80	65	80	100	460	940	170	600	840	187,5	4	260	160	423	160	180	390	350	19	4	121
NOLH 065-125	112M	4	2900	900 x 300 F	B80	65	80	100	460	940	170	600	840	187,5	4	260	160	423	160	180	390	350	19	4	132
NOLH 065-125	132S	5,5	2900	900 x 300 F	B95	65	80	100	460	940	170	600	916	187,5	4	339	160	423	160	180	390	350	19	4	153
NOLH 065-125	132S	7,5	2900	900 x 300 F	B95	65	80	100	460	940	170	600	916	187,5	4	339	160	423	160	180	390	350	19	4	160
NOLH 065-160	132S	5,5	2900	900 x 300 F	B95	65	80	100	460	940	170	600	916	187,5	4	339	160	443	160	200	390	350	19	4	160
NOLH 065-160	132S	7,5	2900	900 x 300 F	B95	65	80	100	460	940	170	600	916	187,5	4	339	160	443	160	200	390	350	19	4	166
NOLH 065-160	132M	9	2900	900 x 300 F	B95	65	80	100	460	940	170	600	954	187,5	4	339	160	443	160	200	390	350	19	4	172
NOLH 065-160	160M	11	2900	1000 x 340 F	B95	65	80	100	460	1040	190	660	1062	207,5	4	410	160	463	160	200	450	400	24	4	218
NOLH 065-160	160M	15	2900	1000 x 340 F	B95	65	80	100	460	1040	190	660	1062	207,5	4	410	160	463	160	200	450	400	24	4	225
NOLH 065-200	132M	9	2900	1000 x 340 F	B95	65	80	100	460	1040	190	660	954	207,5	4	339	180	508	180	225	450	400	24	4	191
NOLH 065-200	160M	11	2900	1000 x 340 F	B95	65	80	100	460	1040	190	660	1062	207,5	4	410	180	508	180	225	450	400	24	4	224
NOLH 065-200	160M	15	2900	1000 x 340 F	B95	65	80	100	460	1040	190	660	1062	207,5	4	410	180	508	180	225	450	400	24	4	232
NOLH 065-200	160L	18,5	2900	1000 x 340 F	B95	65	80	100	460	1040	190	660	1106	207,5	4	410	180	508	180	225	450	400	24	4	247
NOLH 065-200	180M	22	2900	1120 x 380 F	B110	65	80	100	460	1160	210	740	1128	227,5	4	450	180	508	180	225	490	440	24	4	332
NOLH 065-200	200L	30	2900	1250 x 430 F	B125	65	80	100	460	1310	235	840	1231	252,5	4	494	180	508	180	225	540	490	24	4	436
NOLH 065-250	160L	18,5	2900	1120 x 380 F	B95	65	80	100	570	1160	210	740	1216	210	4	410	200	553	200	250	490	440	24	4	308
NOLH 065-250	180M	22	2900	1250 x 430 F	B110	65	80	100	570	1310	235	840	1238	235	4	450	200	553	200	250	540	490	24	4	389
NOLH 065-250	200L	30	2900	1250 x 430 F	B125	65	80	100	570	1310	235	840	1341	235	4	494	200	553	200	250	540	490	24	4	462

* = C tes données ^ titre indicatif, ne pas utiliser ces valeurs pour réalisation.

NOLH

DIMENSIONS – GROUPES – 2900 MIN-1 SANS SPACER

Type pompe	Type moteur	Puissance nom. moteur (P2h en kW)	Vitesse	châssis	Accouplement	DND	DNS	a	LP	L1*	L2*	L3*	L*	S1	x	HM	Hs*	HP	H1	H2	B2*	B3*	Ø d*	n*	Poids groupe
NOLH 065-250	200L	37	2900	1250 x 430 F	B125	65	80	100	570	1310	235	840	1341	235	4	494	200	553	200	250	540	490	24	4	477
NOLH 065-250	225S-M	45	2900	1400 x 480 F	B125	65	80	100	570	1460	260	940	1391	260	4	593	200	553	200	250	610	550	29	4	690
NOLH 080-160	132S	7,5	2900	1000 x 340 F	B95	80	100	125	485	1040	190	660	941	232,5	4	339	180	508	180	225	450	400	24	4	183
NOLH 080-160	132M	9	2900	1000 x 340 F	B95	80	100	125	485	1040	190	660	979	232,5	4	339	180	508	180	225	450	400	24	4	189
NOLH 080-160	160M	11	2900	1000 x 340 F	B95	80	100	125	485	1040	190	660	1087	232,5	4	410	180	508	180	225	450	400	24	4	222
NOLH 080-160	160M	15	2900	1000 x 340 F	B95	80	100	125	485	1040	190	660	1087	232,5	4	410	180	508	180	225	450	400	24	4	230
NOLH 080-160	160L	18,5	2900	1000 x 340 F	B95	80	100	125	485	1040	190	660	1131	232,5	4	410	180	508	180	225	450	400	24	4	245
NOLH 080-160	180M	22	2900	1120 x 380 F	B110	80	100	125	485	1160	210	740	1153	252,5	4	450	180	508	180	225	490	440	24	4	330
NOLH 080-200	160M	15	2900	1120 x 380 F	B95	80	100	125	595	1160	210	740	1197	309	4	410	180	533	180	250	490	440	24	4	282
NOLH 080-200	160L	18,5	2900	1120 x 380 F	B95	80	100	125	595	1160	210	740	1241	309	4	410	180	533	180	250	490	440	24	4	298
NOLH 080-200	180M	22	2900	1120 x 380 F	B110	80	100	125	595	1160	210	740	1263	309	4	450	180	533	180	250	490	440	24	4	347
NOLH 080-200	200L	30	2900	1250 x 430 F	B125	80	100	125	595	1310	235	840	1366	334	4	494	180	533	180	250	540	490	24	4	452
NOLH 080-200	200L	37	2900	1250 x 430 F	B125	80	100	125	595	1310	235	840	1366	334	4	494	180	533	180	250	540	490	24	4	466
NOLH 080-200	225S-M	45	2900	1400 x 480 F	B125	80	100	125	595	1460	260	940	1416	359	4	593	180	533	180	250	610	550	29	4	680
NOLH 080-250	180M	22	2900	1250 x 430 F	B110	80	100	125	595	1310	235	840	1263	260	4	450	200	583	200	280	540	490	24	4	395
NOLH 080-250	200L	30	2900	1250 x 430 F	B125	80	100	125	595	1310	235	840	1366	260	4	494	200	583	200	280	540	490	24	4	468
NOLH 080-250	200L	37	2900	1250 x 430 F	B125	80	100	125	595	1310	235	840	1366	260	4	494	200	583	200	280	540	490	24	4	482
NOLH 080-250	225S-M	45	2900	1400 x 480 F	B125	80	100	125	595	1460	260	940	1416	285	4	593	200	583	200	280	610	550	29	4	695
NOLH 080-250	250S-M	55	2900	1600 x 530 F	B140	80	100	125	595	1660	300	1060	1522	325	4	618	200	603	200	280	660	600	29	4	820
NOLH 100-160	160L	18,5	2900	1250 x 430 F	B95	100	125	125	595	1310	235	840	1241	260	4	410	200	583	200	280	540	490	24	4	348
NOLH 100-160	180M	22	2900	1250 x 430 F	B110	100	125	125	595	1310	235	840	1263	260	4	450	200	583	200	280	540	490	24	4	398
NOLH 100-160	200L	30	2900	1250 x 430 F	B125	100	125	125	595	1310	235	840	1366	260	4	494	200	583	200	280	540	490	24	4	471
NOLH 100-160	200L	37	2900	1250 x 430 F	B125	100	125	125	595	1310	235	840	1366	260	4	494	200	583	200	280	540	490	24	4	485
NOLH 100-200	160L	18,5	2900	1120 x 380 F	B95	100	125	125	595	1160	210	740	1241	235	4	410	200	583	200	280	490	440	24	4	308
NOLH 100-200	180M	22	2900	1250 x 430 F	B110	100	125	125	595	1310	235	840	1263	260	4	450	200	583	200	280	540	490	24	4	389
NOLH 100-200	200L	30	2900	1250 x 430 F	B125	100	125	125	595	1310	235	840	1366	260	4	494	200	583	200	280	540	490	24	4	462
NOLH 100-200	200L	37	2900	1250 x 430 F	B125	100	125	125	595	1310	235	840	1366	260	4	494	200	583	200	280	540	490	24	4	477
NOLH 100-200	225S-M	45	2900	1400 x 480 F	B125	100	125	125	595	1460	260	940	1416	285	4	593	200	583	200	280	610	550	29	4	690
NOLH 100-250	200L	30	2900	1250 x 430 F	B125	100	125	140	610	1310	235	840	1381	275	4	494	225	608	225	280	540	490	24	4	478
NOLH 100-250	200L	37	2900	1250 x 430 F	B125	100	125	140	610	1310	235	840	1381	275	4	494	225	608	225	280	540	490	24	4	493
NOLH 100-250	225S-M	45	2900	1400 x 480 F	B125	100	125	140	610	1460	260	940	1431	300	4	593	225	608	225	280	610	550	29	4	706
NOLH 100-250	250S-M	55	2900	1600 x 530 F	B140	100	125	140	610	1660	300	1060	1537	340	4	618	225	628	225	280	660	600	29	4	830
NOLH 100-250	280S-M	75	2900	1800 x 600 F	B160	100	125	140	610	1860	330	1200	1652	370	6	743	225	628	225	280	730	670	29	4	1102
NOLH 100-250	280S-M	90	2900	1800 x 600 F	B160	100	125	140	610	1860	330	1200	1652	370	6	743	225	628	225	280	730	670	29	4	1154
NOLH 125-200	250S-M	55	2900	1600 x 530 F	B140	125	150	140	610	1660	300	1060	1537	340	4	618	250	688	250	315	660	600	29	4	846
NOLH 125-200	280S-M	75	2900	1800 x 600 F	B160	125	150	140	610	1860	330	1200	1652	370	6	743	250	688	250	315	730	670	29	4	1118
NOLH 125-200	280S-M	90	2900	1800 x 600 F	B160	125	150	140	610	1860	330	1200	1652	370	6	743	250	688	250	315	730	670	29	4	1170
NOLH 125-200	315S-M	110	2900	2100 x 740 F	B160	125	150	140	610	2140	370	1400	1742	410	6	807	250	688	250	315	860	790	29	4	1347

* = C tes donnÉes ^ titre indicatif, ne pas utiliser ces valeurs pour rÉalisation.

FICHE DE RENSEIGNEMENTS POUR PRODUIT PLACÉ DANS UNE ZONE ATEX (1/2)

DIRECTIVE 94/9/CE



Cadre r serv  ^ Salmson

Code client:

N  commande:

COORDONNEES:

Nom (ou soci t ):

Adresse:

Interlocuteur:

Code postal:

Activit :

Ville:

T . Fax:

E-mail:

Remplacement d'une pompe Salmson ou Essamico:

(si la pompe est connue, ne pas remplir les caract ristiques de l'installation)

Type de pompe:

Commentaires:

N  de s rie:

Caract ristiques du LIQUIDE:

Nature:

Densit :

Liquide clair ou abrasif

Additifs: ^ %

Taille et nature des abrasifs:

PH:

Temp rature:  C

Liquide Inflammable: oui non

Viscosit : ^ temp.:

Remarques:

Caract ristiques de l'INSTALLATION (si d finies):

D bit: m /h

Filtre: oui non

Pression: m

Nb de vannes ^ l'aspiration

NPSH disponible: m

Nb de coudes ^ l'aspiration:

ou description de l'installation ^ valider

D bit dans la pompe: m /h

Aspiration ou en charge

Hauteur de refoulement au point le plus haut (hr): m

Si aspiration, hauteur minimale du liquide ^ l'axe de l'aspiration (ha):

Longueur d'velopp e de la tuyauterie au refoulement (lr): m

Si en charge, hauteur de charge mini par rapport l'axe de l'aspiration

Diam tre de la tuyauterie de refoulement(dr): mm

(hc):

Nb de vannes au refoulement:

Longueur d'velopp e de la tuyauterie ^ l'aspiration(la):

Nb de coudes au refoulement:

Diam tre de la tuyauterie d'aspiration (da): mm

Remarques:

Clapet de pied de cr pine: oui non

MERCI DE RETOURNER CE DOCUMENT  :

53, bd de la R publique - Espace Lumi re - B t. 6 - 78403 Chatou Cedex

SALMSON Contact: 0 820 0000 44 (n  Indigo)

www.salmson.com | Fax: 01 30 09 82 34



NOLH

FICHE DE RENSEIGNEMENTS POUR PRODUIT PLACÉ DANS UNE ZONE ATEX (2/2)

DIRECTIVE 94/9/CE



Caractéristiques du MOTEUR :

Tension disponible :

230V mono 230V tri 400V tri

Autre type de moteur :

Préciser :

Fréquence : 50 hz 60 hz variable

Plage de fréquence :

Temps de fonctionnement : h/jour

Nombre de démarrages : /h

Caractéristiques ATEX selon directive 1999 / 92 :

Dans le cas où le produit devra être installé dans une zone à risque classé ATEX, la directive 1999 / 92 vous oblige à définir le niveau de risque. Afin de vous aider dans cette démarche, nous vous demandons de bien vouloir remplir toutes les zones suivantes en cochant une case par rubrique.

L'ensemble des données de ces feuilles seront reprises pour la définition de la pompe ainsi que son niveau de protection. La pompe ainsi définie ne pourra être utilisée que dans ces conditions. Pompe Salmson déclinant toute responsabilité en cas d'utilisation différente.

-Définition de la zone de risque selon la directive

1999 / 92 et EN 1127-1.

Zone 0 la zone 20 n'étant pas couverte par nos produits

Zone 1 la zone 21 n'étant pas couverte par nos produits

Zone 2 la zone 22 n'étant pas couverte par nos produits

Classe de température choisie :

T1 T2 T3

450°C 300°C 200°C

T4 T5 T6

135°C 100°C 80°C

Catégorie de mélange gazeux pour les appareils du groupe

IIA IIB IIC

Remarques :

Signature :

Fait à :

Nom :

Le :

Signature :