

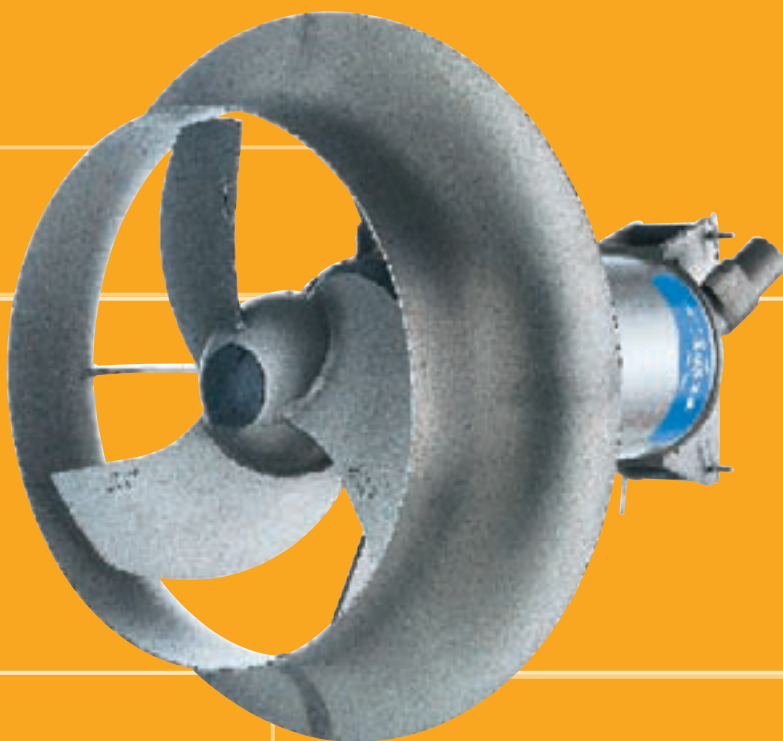

Water & Wastewater

Flygt compact mixers

A range to match any requirements



Engineered for life

motralec

4 rue Lavoisier . ZA Lavoisier . 95223 HERBLAY CEDEX
Tel. : 01.39.97.65.10 / Fax. : 01.39.97.68.48
Demande de prix / e-mail : service-commercial@motralec.com
www.motralec.com

Better mixing and reduced power consumption

Compared to dry-mounted mixers, submersible solutions offer greater flexibility and considerable savings in energy consumption for a wide range of mixing applications, such as solids suspension, bottom erosion, blending, circulation or destratification.

How does mixing work?

All mixing applications require varying degrees of both small-scale turbulence and bulk flow. With a good bulk flow, the contents of the entire tank are put in motion so that all parts are involved in the mixing. Most mixing applications generate abundant turbulence and it is the strength of the bulk flow that controls the efficiency of the mixing. The performance of a submersible mixer is measured by the thrust (N) that it produces. So the strength of the bulk flow is in turn dependent on the total amount of installed thrust.

Submersible mixers mean more efficient bulk flow

Submersible mixers allow a great deal of flexibility in positioning and orientation, unlike their dry-mounted counterparts. The mixer jet can be positioned to develop over a long distance and adapted to the shape of the tank. This ensures the creation of a maximum level of bulk flow. The result: more efficient mixing and lower power consumption.

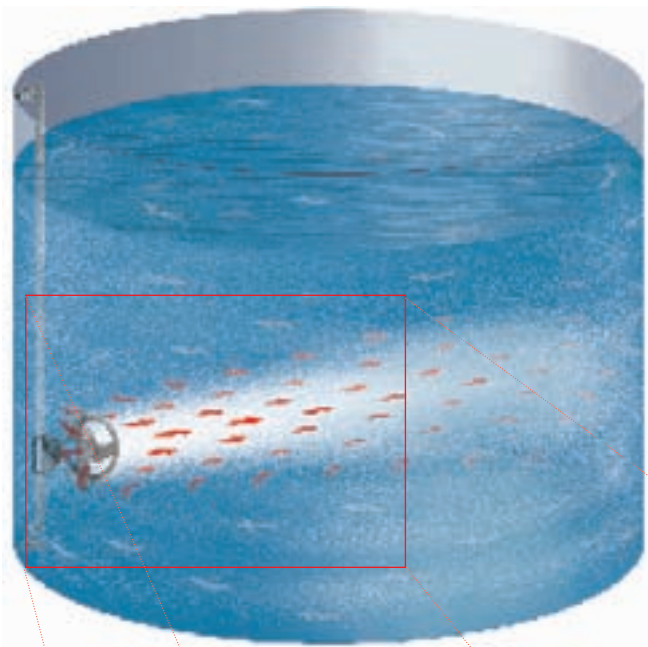

Allowing the mixer jet to develop leads to a good bulk flow and efficient mixing of the entire tank.

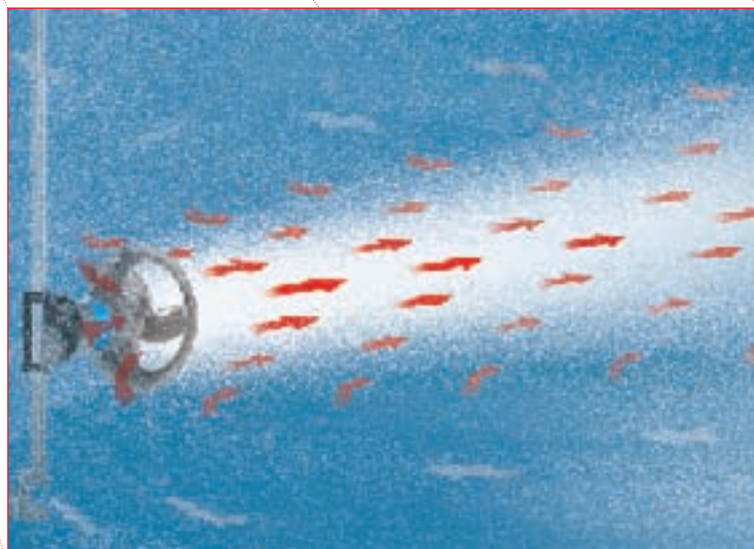

A submersible mixer offers more flexibility in positioning and orientation.

Easy and quick to install



In comparison with dry-mounted mixer installations, the submersible solution is often preferred. It presents a quick and easy installation with low capital investment since there is no need for costly catwalks, external transmission or concrete motor supports.

No expensive modifications

Thanks to the flexibility of installation, the mixing equipment can be used in existing tanks without the need for expensive alterations to the site.

There are a wide range of installation techniques that can be used for installing submersible mixers. The most frequently-used methods are detailed to the right. We can also advise on other mounting solutions.

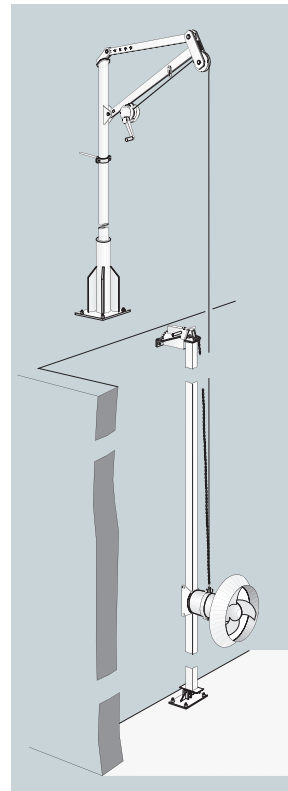

Guide bar mounting

The most common installation method. The mixer is lowered or raised along a guide bar located on the tank wall.

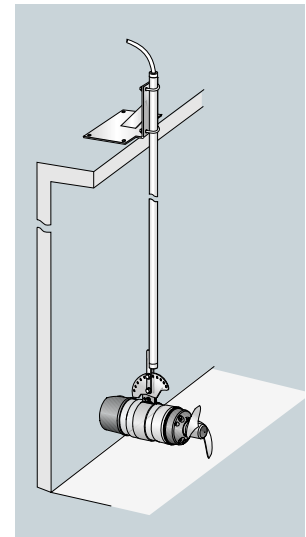

Cantilever mounting

Small mixers can be mounted on a cantilever bar which is simply clamped or bolted onto the tank edge.

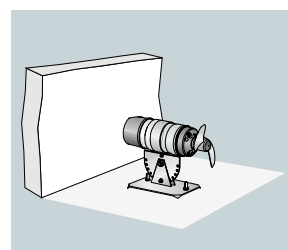

Floor mounting

Often used in shallow tanks and ponds. The mixer is fixed to a stand on the bottom.

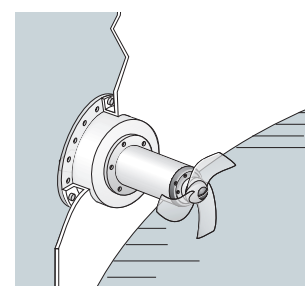

Flange mounting

The mixer is fixed to an adapter flange, which in turn is mounted in the tank inspection hole (patent pending).

Mixers to meet any requirement

Flygt 4600 compact mixers offer cost effective solutions in a wide variety of mixing applications, such as:

- Biological treatment tanks
- Sludge holding tanks
- Equalisation tanks
- pH stabilisation tanks
- Chlorination basins
- Paper pulp chests
- Ore slurry pump sumps
- Lime slurry storage tanks
- Bentonite preparation tanks
- Heat exchangers
- Quenching tanks
- Ice prevention
- Manure tanks
- and many more

4600 Mixers

ITT Water & Wastewater offers 8 different sizes of direct driven mixers. Using a standardised range of components and materials, the modular design which includes a series of blade angles for each model, means a comprehensive selection of mixer performance.

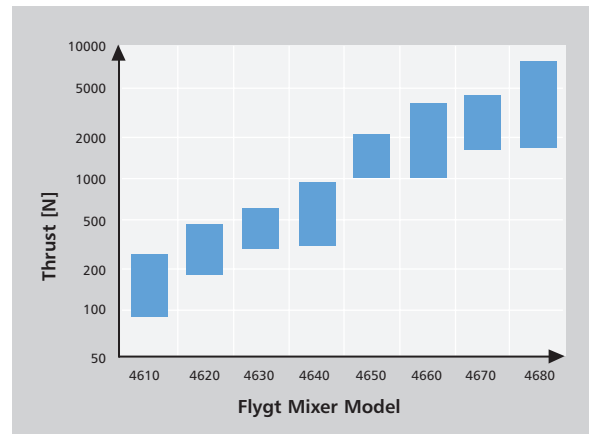

Model	4610 Mixer	4620 Mixer	4630 Mixer	4640 Mixer	4650 Mixer	4660 Mixer	4670 Mixer	4680 Mixer
Shaft power	50 Hz, 0.75 kW 60 Hz, 0.9 kW/1.2 hp	50 Hz, 1.5 kW 60 Hz, 1.7 kW/2.3 hp	50 Hz, 1.5 kW 60 Hz, 1.9 kW/2.5 hp	50 Hz, 2.5 kW 60 Hz, 3.0 kW/4.0 hp	50 Hz, 5.5 kW 60 Hz, 6.2 kW/8.3 hp	50 Hz, 10.0 kW 60 Hz, 11.2 kW/15.0 hp	50 Hz, 13.0 kW 60 Hz, 14.9 kW/20.0 hp	50 Hz, 25.0 kW 60 Hz, 30.0 kW/40.0 hp
Max. nominal thrust	50 Hz, 0.20 kN 60 Hz, 0.22 kN/50 lb	50 Hz, 0.34 kN 60 Hz, 0.39 kN/90 lb	50 Hz, 0.48 kN 60 Hz, 0.51 kN/110 lb	50 Hz, 0.79 kN 60 Hz, 0.82 kN/180 lb	50 Hz, 1.9 kN 60 Hz, 1.6 kN/350 lb	50 Hz, 2.9 kN 60 Hz, 3.2 kN/700 lb	50 Hz, 3.8 kN 60 Hz, 3.8 kN/850 lb	50 Hz, 6.4 kN 60 Hz, 7.0 kN/1600 lb
Propeller diameter	210 mm 8 1/2"	210 mm 8 1/2"	368 mm 14 1/2"	368 mm 14 1/2"	580 mm 22 7/8"	580 mm 22 7/8"	766 mm 30 1/4"	766 mm 30 1/4"

With jet ring

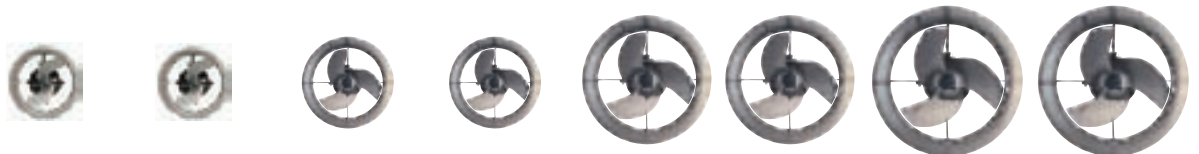

Without jet ring



Reliability starts with attention to detail

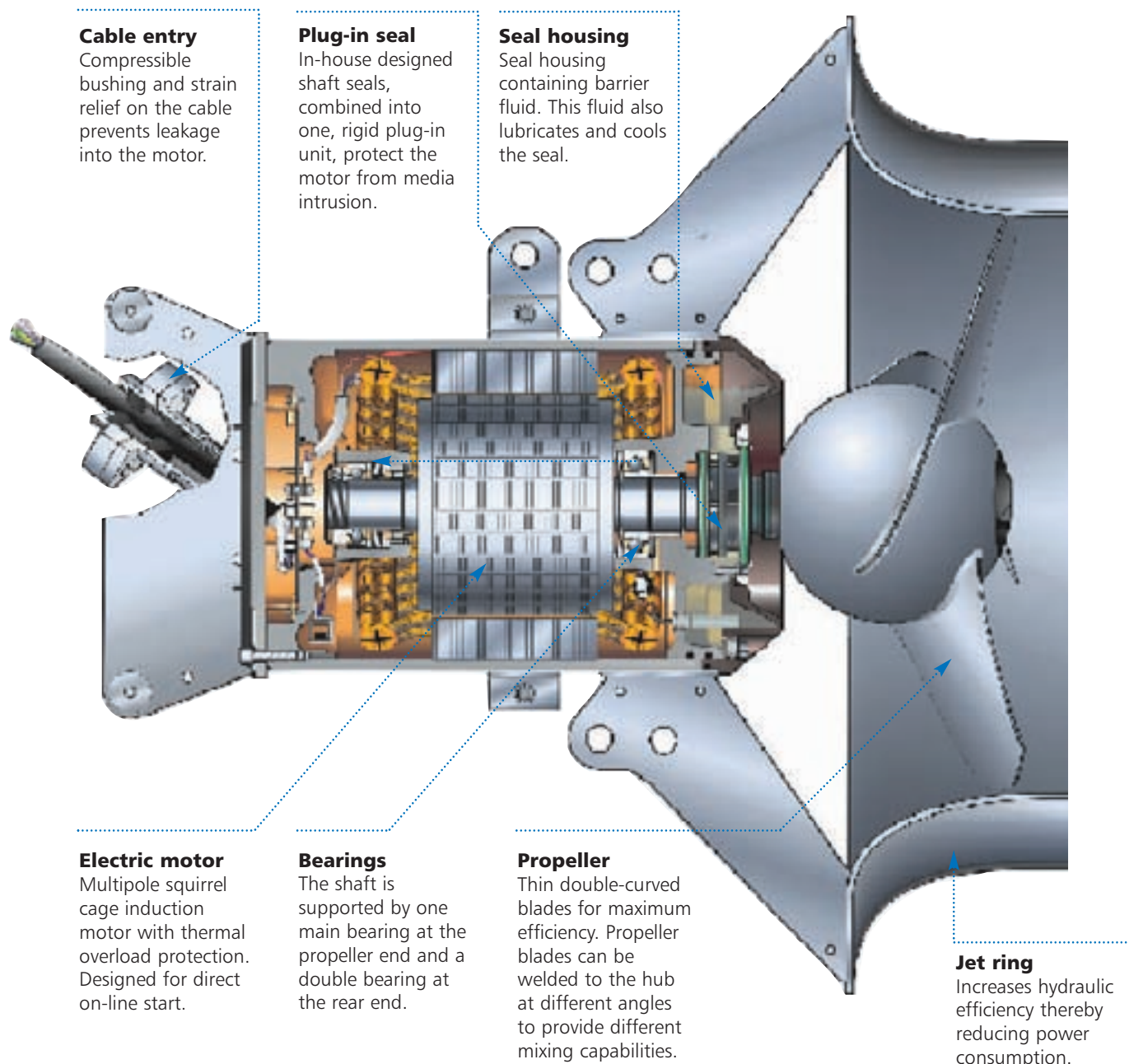

Maximum thrust minimum power

How well a mixer performs depends primarily on the design of the hydraulic parts. And the mixing result in most applications depends on a good bulk flow being generated throughout the tank. This is why all Flygt mixers are designed to generate the maximum of thrust with the minimum of power consumption.

Efficiency must also be maintained in highly fibrous media without the propellers clogging. The swept-back design of Flygt mixer propellers minimises this risk.

Add a jet ring, boost efficiency even further

A well-designed jet ring can substantially increase the efficiency of a mixer, thus further reducing power consumption for the same or even higher thrust. The jet leaving the mixer is axial, but the inflow is mostly radial. The jet ring reduces losses connected to this change of flow direction, as well as losses from blade tip recirculation. Efficiency can increase 10–15% in water and even more in viscous media.

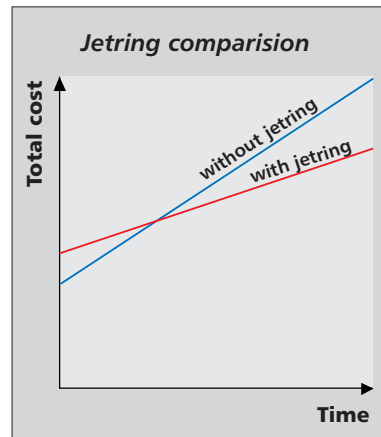

A jet ring often presents a short pay-back time.



Mixers from ITT Water & Wastewater have well proven performance data.



Stainless steel for longer life

Frequently, mixers have to operate in corrosive and/or abrasive liquids, and both abrasion and corrosion may affect the mixer, especially the propeller. The corrosivity of a liquid can be for a number of different reasons, such as dissolved oxygen, low pH, chloride content or certain micro-organisms. Abrasion is caused by hard particles in the mixed media.

Which material offers the best corrosion protection?

ASTM 316L stainless steel is often the preferred choice of material for Flygt 4600 mixers. Thanks to its molybdenum content it provides excellent corrosion resistance even in liquids containing chlorides. This makes it the recommended alternative in many wastewater treatment plants and in most process industry applications. ASTM 304 mixers is an alternative for less corrosive liquids (chlorides <200ppm at pH7). For highly aggressive media such as sea water, mixers are available in Proacid 254 (see diagram).

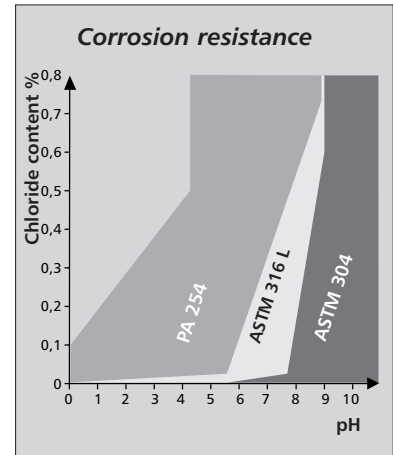

The fields of application of Proacid 254, ASTM 316L and ASTM 304 depend on the levels of pH and chlorides.

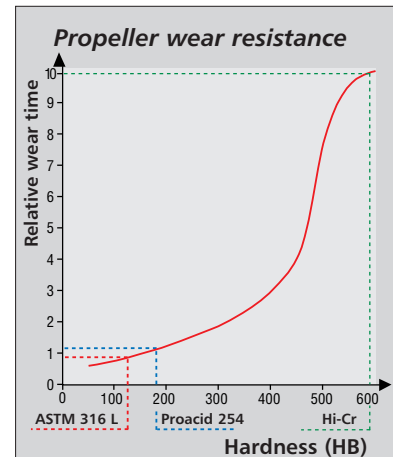
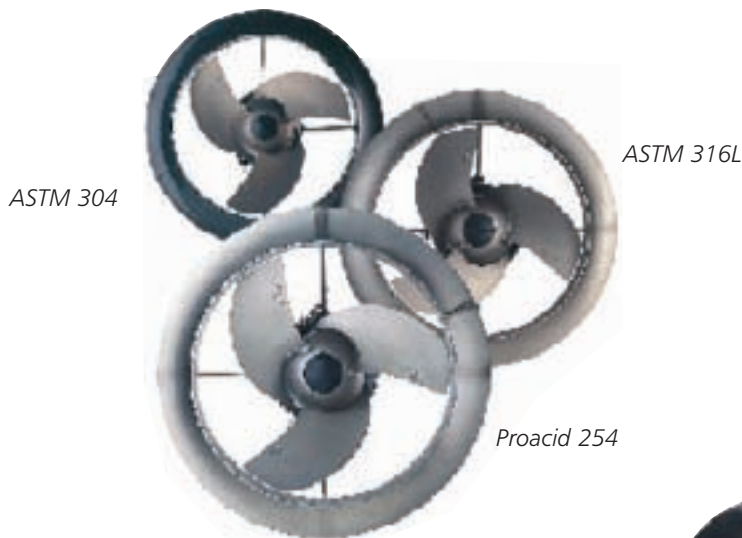

Material	Hardness (HB)
ASTM 316L	170
Proacid 254	200
HiCr cast iron	600

The hardness of the propeller material is an important consideration in abrasive media.

Getting tough on abrasion

Ordinary metals may suffer severe abrasion when mixing hard mineral slurries. To combat this, Flygt 4600 mixer propellers are also available in High chromium white cast iron. This is an extremely abrasion-resistant alloy: however, it offers limited corrosion resistance and is not recommended for use below a pH of 5,5.



High chromium cast iron propeller

The right seal for your application

Shaft seals are a crucial component in the reliability of a submersible mixer. Flygt 4600 mixers have double mechanical shaft seals and an intermediate barrier fluid. The inner and the outer seals are combined into one rigid plug-in seal unit.

Why do seals wear out?

Theoretically, the surfaces of the mechanical seals are constantly divided by a liquid film. In reality there is always some direct contact between the rings leading to wear of the seal surfaces. This is why the choice of material, and its sliding properties, is extremely important to the longevity of a mechanical seal.

Tungsten Carbide or Silicon Carbide?

ITT Water & Wastewater gives you two choices of seal material for the 4600 mixers: corrosion-resistant tungsten carbide (WCCR) or silicon carbide (SiC).

WCCR is the optimum choice in most applications. Its superior sliding properties mean significantly less

wear between the two seal surfaces, offering a longer life with less risk of leakage. It offers better mechanical strength and is far less brittle and sensitive to handling damage than SiC.

WCCR has a binder where chromium, nickel and molybdenum have been added giving excellent corrosion resistance down to a pH of 3.

SiC is the better choice in two kinds of conditions: when the pH is lower than 3, and when mixing small particles that are harder than WCCR.

	Bending strength (MPa)	Fracture toughness (MPam ^{1/2})
WCCR	2600	18
SiC	390	4.5

WCCR has superior mechanical properties.



Reliable equipment, easy to work with

Installation accessories should be rigid enough to withstand the weight and reaction forces exerted by the mixer year after year. Professional operators also need the equipment to be easy to work with for installation, as well as inspection and service.

Guide bars for any tank

In most Flygt submersible mixer applications, a guide bar is used together with a lifting davit, which is supported by an upper and lower guide bar bracket. Long guide bars can also be fitted with an intermediate bracket. The brackets allow the guide bar to be angled for different positionings of the mixer. The mixer can be installed at any depth along the guide bar, depending on the application.

Convenient and safe lifting equipment

ITT Water & Wastewater provides equipment that enables convenient lifting and handling of mixers. The safety is guaranteed with the CE marking, the European sign for safety approval.

The lifting davit is mounted in a holder at its lower end which enables easy turning of the davit. To raise the mixer, the davit is fitted with either a winch or a pulley block.

To reduce investment cost, one davit can be used for several mixers. Mixers can be left submerged without being suspended by the lifting wire. One solution is a ITT Water & Wastewater patented lifting device that guarantees the connection to a lifting bail on the mixer.



Equipped for every condition

Explosion-proof versions

For duty in explosive or flammable environments, all Flygt mixers are available in Ex-approved versions.



Stator drainage detector

Since a mechanical shaft seal consists of two moving surfaces, it is not hermetically tight. So there may be a small, controlled leakage. A miniature sensor can be installed to automatically detect any need for draining.



Supervision

Surveillance of thermal overload switches and drainage detectors is preferably handled by Flygt MiniCAS. This relay is an easy way to ensure protection of your equipment.

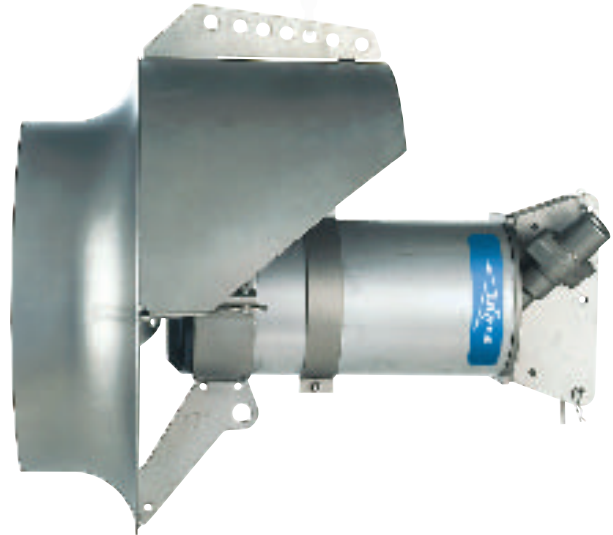

Patented vortex protection shield

In some applications the liquid depth is very shallow; in other cases the mixer must be placed close to the surface. This may cause air vortices to be drawn from the surface into the mixer propeller, causing damage to the propeller and resulting in a drop in performance. To prevent this, Flygt mixers can be equipped with a patented vortex protection shield.

Seal flushing

When mixing very fine particles (smaller than the liquid film between the surfaces of the mechanical seal), these particles may penetrate the seal. To prevent this, Flygt mixers can be equipped with accessories for flushing the seal with either air or water.

Trouble-free operation, year after year



Local service network – worldwide

The service and maintenance of equipment is a key factor in any professional operation. At ITT Water & Wastewater we offer an unparalleled worldwide network, so that there is always a professional service centre close to your operations, with fully equipped workshops and trained service engineers.

Total service concept

Every mixer installation and system is different and so are the levels of service and support that you may require. With ITT Water & Wastewater, you can choose the level of service to suit your needs. From simply supplying mixers, to full service assistance and maintenance, ITT Water & Wastewater's total service concept means the service you require, on your terms.



Easier servicing – check the web

In the design stages of our mixers, we pay great attention to the ability of offering prompt and easy on-site service. This, in combination with the availability of service kits means minimum downtime. For customers who wish to service their own mixers, extensive Workshop and Care & Maintenance manuals are available, as printed matter or at www.ittwww.com.



15-year spare parts guarantee

We guarantee the availability of spare parts for 15 years after the production of a mixer has stopped. Just another way that ITT Water & Wastewater guarantees its long-term commitment to its customers.



What can ITT Water & Wastewater do for you?

Integrated solutions for fluid handling are offered by ITT Water & Wastewater as a world leader in transport and treatment of wastewater. We provide a complete range of water, wastewater and drainage pumps, equipment for monitoring and control, units for primary and secondary biological treatment, products for filtration and disinfection, and related services. ITT Water & Wastewater, headquartered in Sweden, operates in some 140 countries across the world, with own plants in Europe, China and North and South America. The company is wholly owned by the ITT Corporation of White Plains, New York, supplier of advanced technology products and services.



motralec

4 rue Lavoisier . ZA Lavoisier . 95223 HERBLAY CEDEX

Tel. : 01.39.97.65.10 / Fax. : 01.39.97.68.48

Demande de prix / e-mail : service-commercial@motralec.com

www.motralec.com