



Product release

ITT Flygt AB

2006-03-23 Lasse Jansson

## N 3231, 3306, 3312, 3356 and 3400



## 1. Introduction

The successful N-pump series grows in size. The first large N pumps are 3231, 3306, 3312, 3356 and the 3400.

## 2. Product aim

The N-pumps are designed to combine the best non-clogging characteristics with excellent efficiency. The self-cleaning impeller offers a trouble-free operation with sustained high efficiency as the main sales argument.

## 3. Competition

Some of our competitors, like ABS, claim they have a similar solution in their 'contra-block technique'. In fact, the only similarity is that they have an open impeller. They do not have the N-design shape of the leading edge nor the relief groove working together with the leading edge.

## 4. Product program

The new N 3231, 3306, 3312, 3356 and 3400 do not completely cover the C-pumps' QH-range. This varies from pump to pump. For example, the N3312 has slightly higher performance, whereas the 3400 has reduced performance compared to the C-pump.

The NPSH is generally not as good as that of the C-pumps. The final NPSH test was positive and the NPSH curves have been revised from those earlier distributed.

The efficiency of the N pumps is generally good, on a level equaling the C-pumps.

## 5. Specific technical features

- The N-technique offers the most reliable performance for handling of wastewater and sustained high efficiency, using a combination of a special designed leading edge in combination with a relief groove.
- The impellers are of cast iron with a hardened leading edge.
- The insert rings are of cast iron and replaceable.
- Trimming is achieved by shims between insert ring and pump housing.

## 6. Strategies

The N-pumps should be the first choice in wastewater applications or in other applications where the best clogging characteristics are required. The N-pumps are also suitable as problem solvers. Compared to a C-pump, the N-pump should be premium priced. For upgrading of an old Flygt pump station with C-pumps, the choices are rebuilding or replacing by a new N-pump.

## 7. Main market segments/Applications

The N-pump is applicable where contaminated water can be expected. In wastewater applications this pump shall always be the first choice.

## 8. References

An early prototype of the NT3306 has been running in Köping, Sweden for more than 15000 hours. It replaced a CT3306, operated on VFD, which was clogging with rags. The pump station is collecting wastewater from other stations and pumps the wastewater to a treatment plant. The customer was very pleased with the pump, which now has been overhauled and taken over by the customer.

## 9. Sales promotion

These items are available:

- N-brochure part no. 89 59 88
- Poster N3356/765 part no. 89 58 74
- Photos in the photo archive (There are no exterior differences vs. a C-pump).

## 10. Technical documentation

- Dimensional drawings are identical to those for C-pumps. All have been adjusted to apply for both pump types.
- Installation, care and maintenance is updated with the N-pumps.
- Parts lists are updated for the N-pump.
- Product data is not updated, but will be in the future.
- There is no workshop manual available. Most of the valuable information can be found either in 'Installation, care and maintenance' or the technical bulletins of how to rebuild C-pumps.
- Technical bulletins for rebuilding have been issued

## 11. Sales tools

The N3356 and N3231/7X5 have been available in FLYPS for a while. The remaining pumps will be part of the FLYPS update in March.

## 12. Time schedule for launch

The N-pumps are available for sale.

## 13. Prices

See price list.

## 14. Delivery time

Delivery time is equal to the corresponding C-pumps'.

**FLYGT**

## N-pumps 3231, 3306, 3312, 3356, 3400

The large wastewater pumps that cut operating costs



Flygt



**ITT Industries**  
*Engineered for life*

# Cut energy bills. Cut service costs.

They revolutionized the market for small and midrange wastewater pumps. And now they are going to do the same for large pumps.

N-pumps cut costs in two ways. First, they slash energy bills, in some cases by up to 50 percent. Second, they radically reduce the number of service call-outs.

This is why –

- N-pumps are the market's most efficient submersibles for pumping contaminated water.
- N-pumps maintain incredible efficiency month after month because fibrous material cannot build up on the impeller. We call it sustained efficiency.
- N-pumps have excellent non-clogging properties, practically eliminating the risk of blockages.

Higher efficiency *plus* non-clogging performance may sound too good to be true. But after nearly 10 years, small and mid-range N-pumps continue to win market share. And the outlook is similar, if not better, for large N-pumps.



# How it works

The secret behind the award-winning N-technique is the combination of a swept-back leading edge and a relief groove in the volute.

## Nothing to get hooked on

The leading edge on most impellers is axial. This is the ideal shape for rags and other long stringy material to wrap themselves around. To avoid this problem, we flattened and swept back the leading edges of the impeller.

## Relief groove

To help really stubborn material pass through the impeller, we developed a "relief groove". As the impeller turns, rags are forced into this spiral-shaped groove. The combined action helps to tug material from the impeller into the volute where it is free to be pumped away.

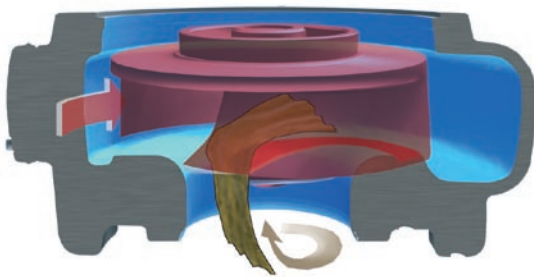

The two-stage action is designed to prevent rags and other fibrous material from accumulating on the impeller.

Stage one: the leading edge is swept back, so there's nothing rags can get caught on.

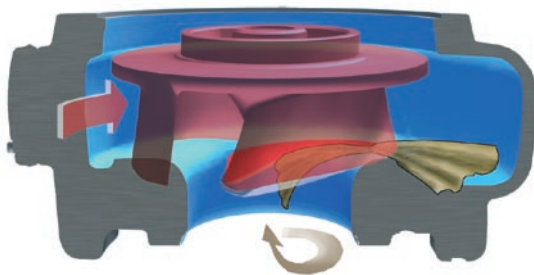

Stage two: rags get fed into the relief groove as the impeller turns, pulling them from the impeller and forcing them into the volute where they get pumped away.

## Cuts energy costs by up to 50 percent

Large savings can be made when pumping contaminated water. This is because N-pumps give you high efficiency, day after day, week after week – we call it sustained efficiency.

## Eliminates build-up and efficiency loss

The problem with conventional impellers is the gradual build-up of stringy material. Over time, the passage in the impeller narrows, reducing the amount of water it can pump. So, as the impeller gradually clogs up, efficiency drops. As you can see in the table below, the N-technique sustains efficiency at its original rated level month after month.

## Sustained efficiency with N-pumps

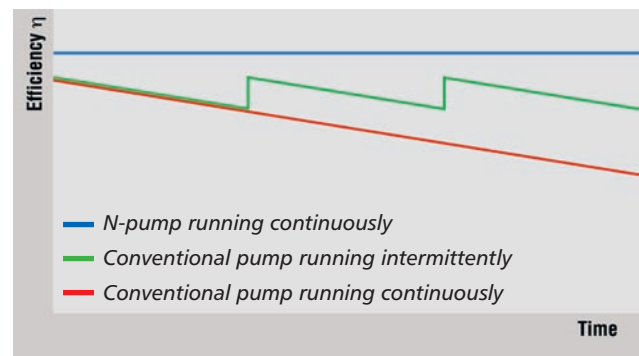

- The red line shows how efficiency decreases when a conventional wastewater pump clogs during continuous operation.
- The green line illustrates how a conventional wastewater pump running intermittently also suffers from low efficiency due to clogging. Temporary efficiency gains may be achieved through back-flushing.
- The blue line shows the sustained efficiency of the N-pump.

# A wide range of applications

By combining increased pumping capacity with the self-cleaning properties of the N-technique, Flygt have opened up new possibilities for cost-effective operation in all kinds of applications:

- Wastewater pumping
- Raw water pumping
- Cooling water
- Sludge handling
- Storm water handling
- Industrial effluent handling
- Irrigation
- Process water

Get it right from the start. Use FLYPS, our proprietary pump selection software, to specify the right pump and SECAD to optimise pump station design.



Flygt submersibles operate directly in the pumped liquid. This means low construction costs because Flygt pumps don't require a special housing or a superstructure. Operating submerged also means that our pumps take up very little space, are quiet and do not need extra cooling.

Flygt submersibles are smaller than non-submersible pumps because motor and hydraulics are integrated in one compact unit. That's why pump stations for submersibles are smaller and less complex to build.

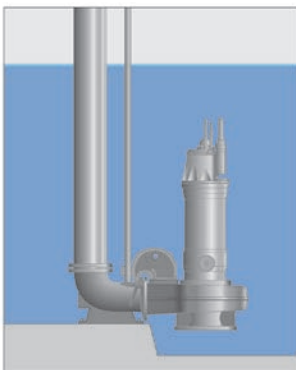

**NP** – For semi-permanent wet well installations: the pump is installed with twin guide bars and a discharge connection.

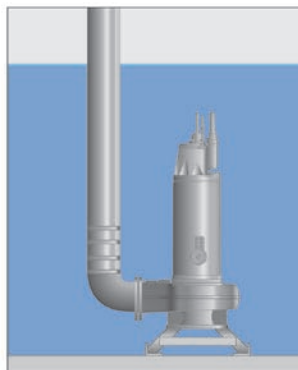

**NS** – This installation makes the pump easy to move around with either a flange that connects to a discharge pipe or a hose coupling.

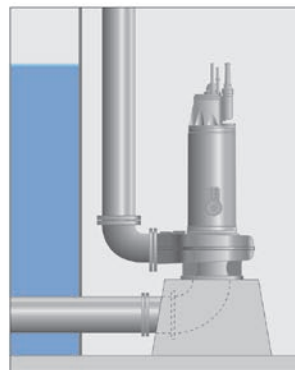

**NT** – A vertical, dry-pit or in-line installation with flange connections for suction and discharge piping.

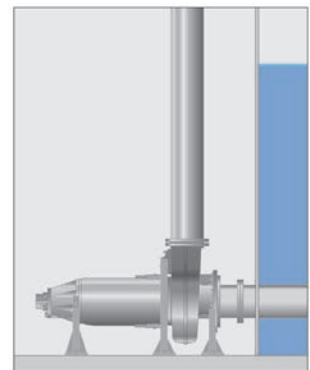





**NZ** – A horizontal, dry-pit or in-line installation with flange connections for suction and discharge piping.

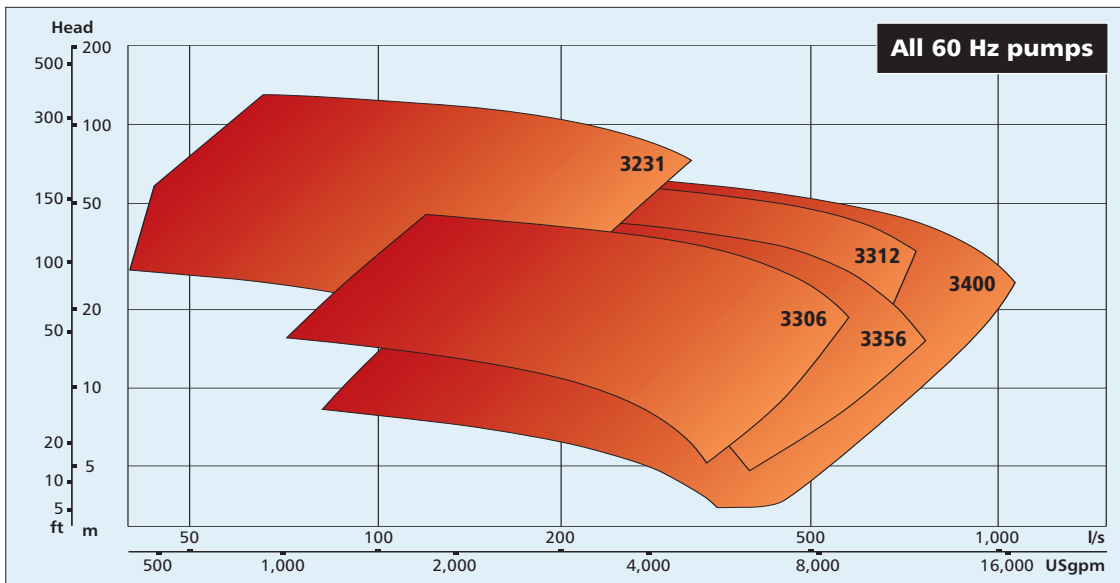
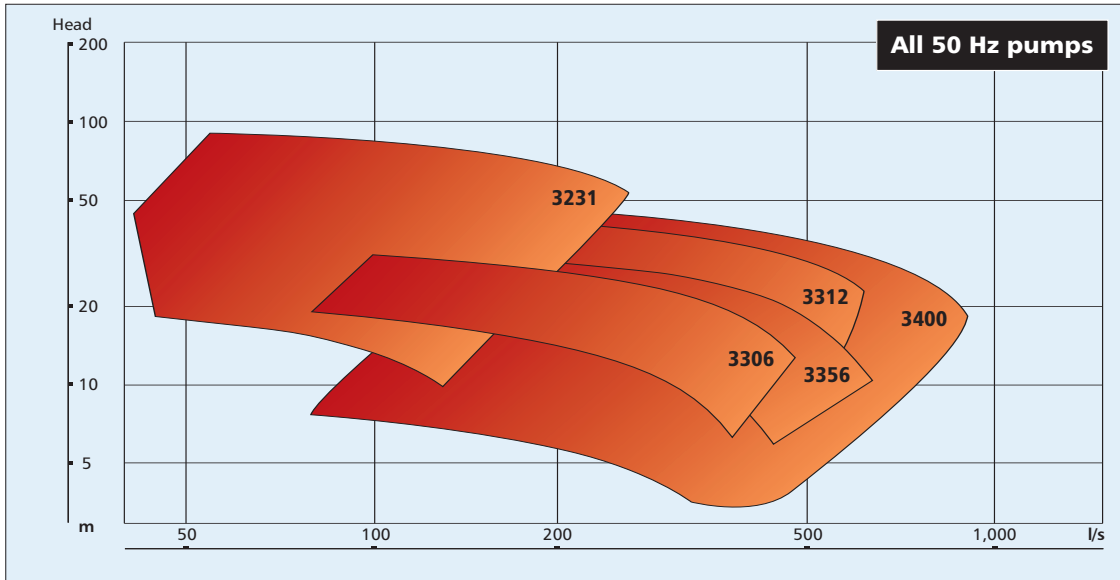

# From 50 to 1,000 l/s 500 to 16,000 USgpm



Model	3231	3306	3312	3356	3400	
<b>Rating</b>	50Hz 60Hz	70 – 215 kW 90 – 335 hp	58 – 100 kW 70 – 280 hp	55 – 250 kW 90 – 470 hp	45 – 140 kW 70 – 280 hp	40 – 310 kW 60 – 470 hp
<b>Discharge</b>	200/8"	300/12"	300/12"	350/14"	400/16"	
						

# Robust design. Reliable performance.

## Cable entry

The cable entrance features a sealing and strain-relief function.

## Efficient cooling

The motor is cooled by the surrounding liquid. A cooling jacket is available for dry-installed pumps and other applications.

## International standards approvals

Each pump is tested and approved in accordance with national and international standards including IEC 34-1, HI plus CSA. The pumps are also available in explosion-proof versions for use in hazardous locations and are approved by the Factory Mutual and European Norm (FM and EN).

## Monitoring

Thermal sensors in the stator windings help prevent overheating and the lower bearing is monitored by an analogue temperature sensor. The stator housing and the junction box are equipped with leakage sensors.

## Long-life bearings

The bearings in all Flygt pumps have been designed to provide a service life of at least 100,000 hours.

## Deflection-resistant shaft

In a Flygt submersible, the shaft's overhang is kept very short to reduce shaft deflection. This results in low vibrations, long seal and bearing life, plus quiet operation.

## Demanding tolerances

All pumps are factory-tested and given a performance guarantee. Tests are conducted according to ISO 9906 grade 1 or 2, HI level A or B.

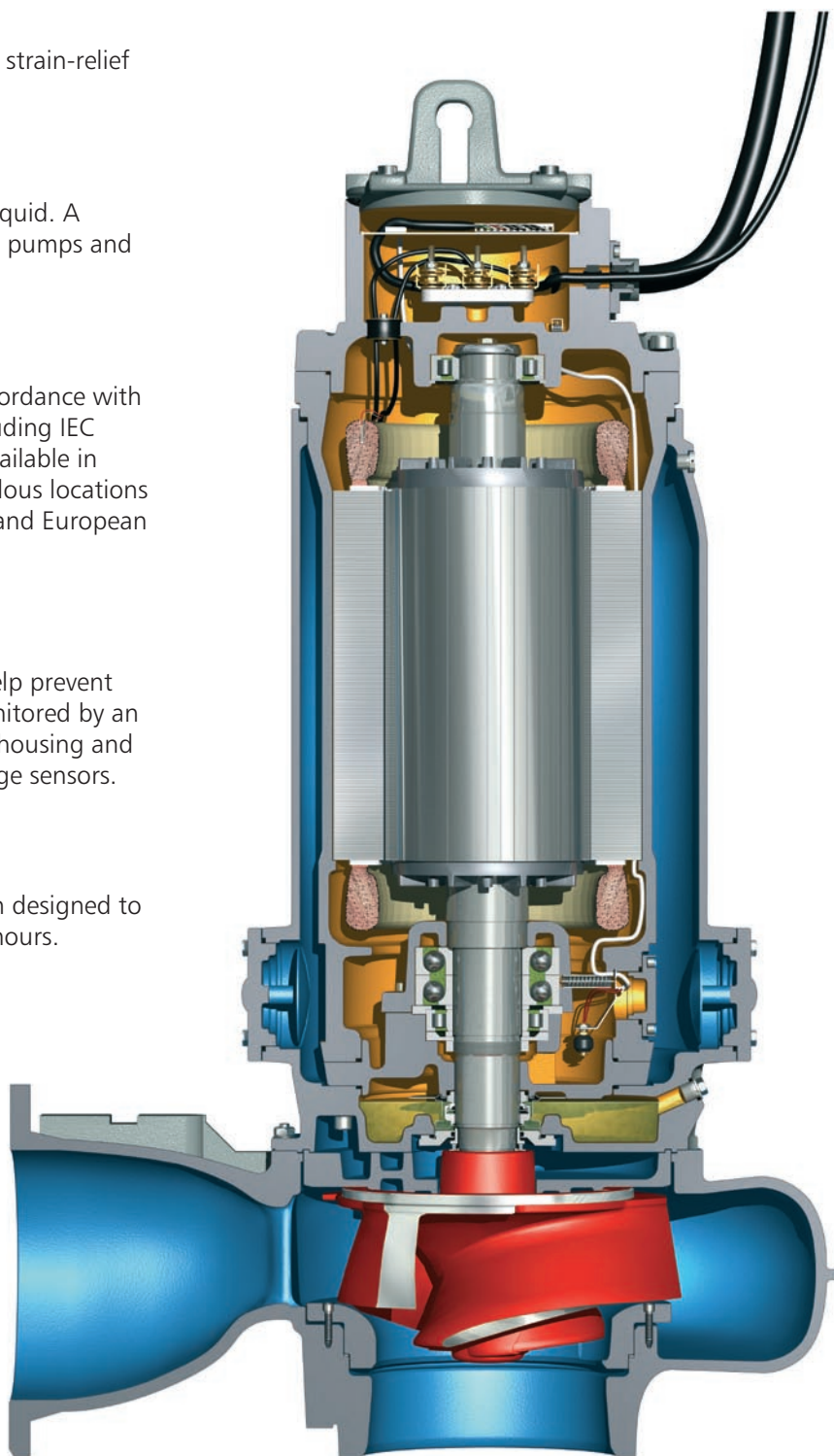

# Engineered for a longer life

At Flygt, we design and manufacture all seals and electrical motors ourselves. It's the best way to ensure the level of reliability and performance our customers expect.

## Long-life seals

Seal surfaces must be able to withstand friction under high pressure and poor lubrication for thousands of hours. Only a few materials are able to cope with such conditions without cracking, seizing up or suffering unacceptable levels of wear.

That's why we use, as standard, a tungsten carbide especially designed for Flygt. It's a material that provides excellent protection against both corrosion and wear. This in turn leads to longer service intervals and safer operation.

Mechanical face seals are normally cooled by the pumped media, but this isn't always the case. To avoid overheating of the outer seal when running dry (Flygt pumps are equipped with double seals), the seal compartment has been designed to dissipate heat quickly and efficiently.



## Class H quality

Inside all N-pumps you'll find a squirrel cage induction motor, made to Class H specifications. Stator windings are trickle impregnated with resin and rated at 180°C (355°F), allowing up to 15 starts per hour.

The maximum temperature rise in a Flygt pump is limited to a NEMA B rise of 80°C (176°F). This ensures a significant increase in the operational life of the motor windings.

## Better heat transfer

In Flygt motors, heat losses are concentrated around the stator which, since it is surrounded by water, is easier to cool than the rotor. Heat transfer is also encouraged because the stator is heat-shrink fitted.

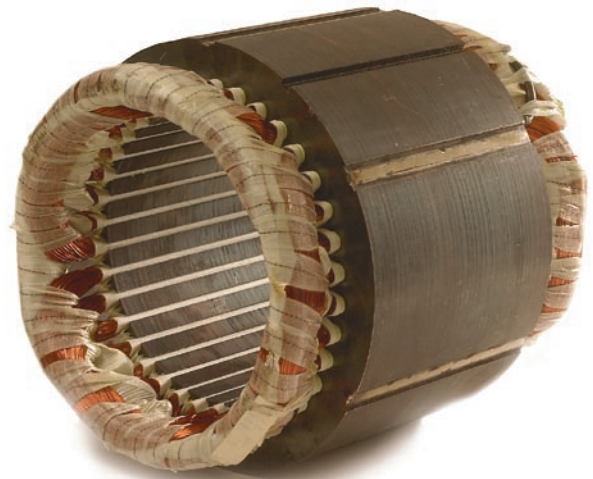

# Monitoring that boosts reliability and cuts life cycle costs

When you begin using N-pumps, you won't be visiting pump stations as often as previously. MAS 711, which is offered as an option, is a monitoring system that will help you keep an eye on your pumps, wherever you are.

The system consists of a base unit, an operator panel and a memory that's built into the pump. Together they monitor and protect your pump by recording results from sensors and measurement modules.

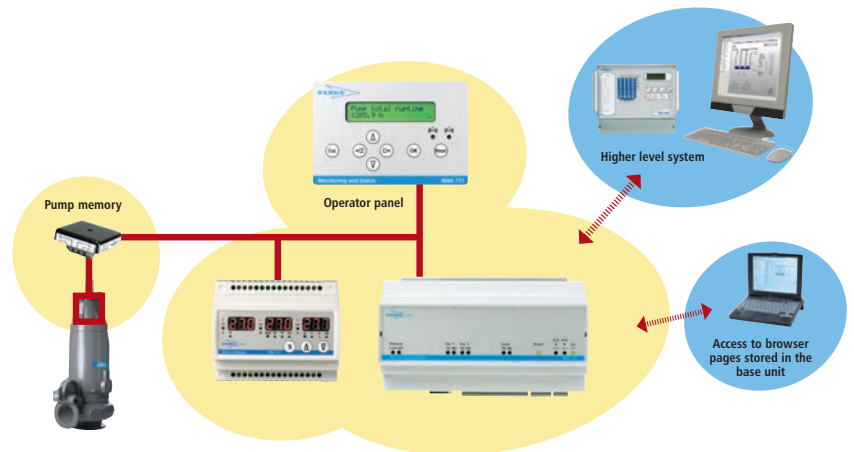

## Wide range of alarms

MAS 711 keeps track of a wide range of parameters including temperature, leakage, vibration, current and power. When an abnormal event occurs, MAS stops the pump and triggers an alarm. Alarm event data are stored making it possible for operators to examine the course of events leading up to an alarm.

## Access data on any PC

Using a standard web browser, you can access and analyse all data from any PC. MAS 711 helps increase reliability and cut maintenance costs by reminding maintenance engineers when service is due.

**AquaView** is a SCADA-based software package that's easy to use and that features an open communication platform.

**Pump controllers** – Flygt offers a complete range of pump controllers with all the functionality you need.

## MAS 711 monitors and records –

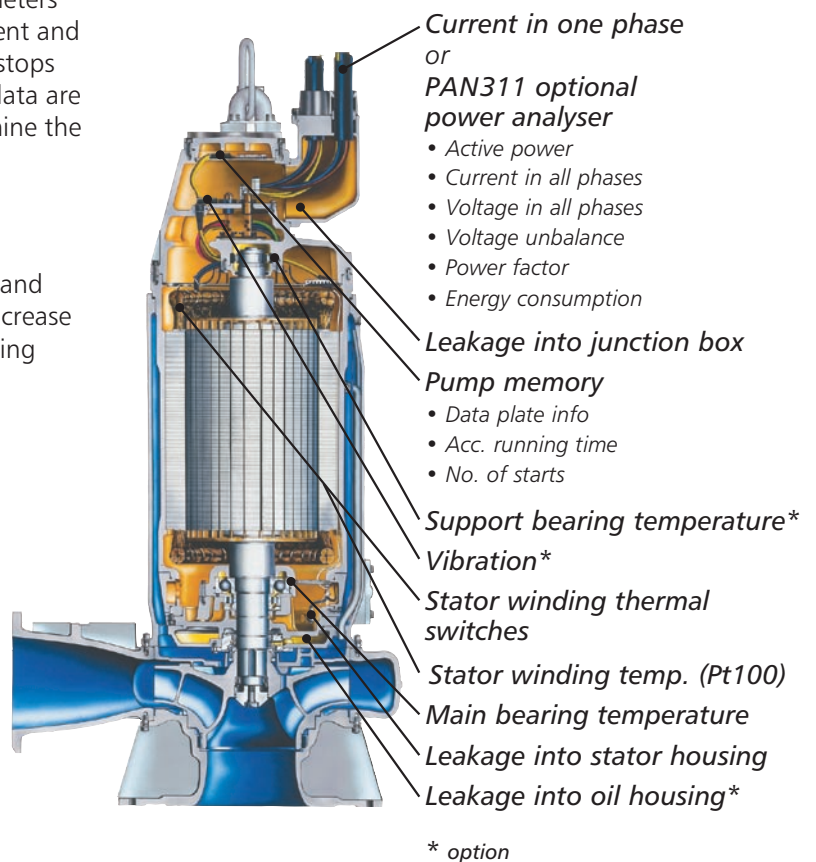

# A faster and safer way to lift large submersible pumps

Retrieving pumps that are completely submerged, or that are located in deep sumps is a difficult business. Dock-Lock™ is a patented lifting device that makes pump retrieval faster and safer.

## Faster

Dock-Lock saves time because the operator doesn't have to "fish around" trying to find the shackle. Instead, a line is always left in place looped through the pump's lifting shackle. When it's time to retrieve the pump, you simply attach the line to Dock-Lock. As you lower the device into the sump, it's guided straight to the shackle by the line.

## Safer

Dock-Lock increases safety because the lifting hook always gets a firm grip on the pump's lifting shackle. When it reaches the top of the pump, it docks with the shackle. This triggers a spring-loaded mechanism that snaps the lifting hook securely into place. The pump can now safely be winched up.



# Convert your C-pumps into N-pumps

If you already operate Flygt C-pumps, you can easily turn them into N-pumps.

There are many reasons to upgrade:

- The N-technique cuts energy bills by up to 50 percent – an N-pump is extremely efficient and remains extremely efficient.
- N-pumps cut the cost of planned and emergency maintenance by reducing the risk of clogging.
- The N-technique improves the return on your original investment.

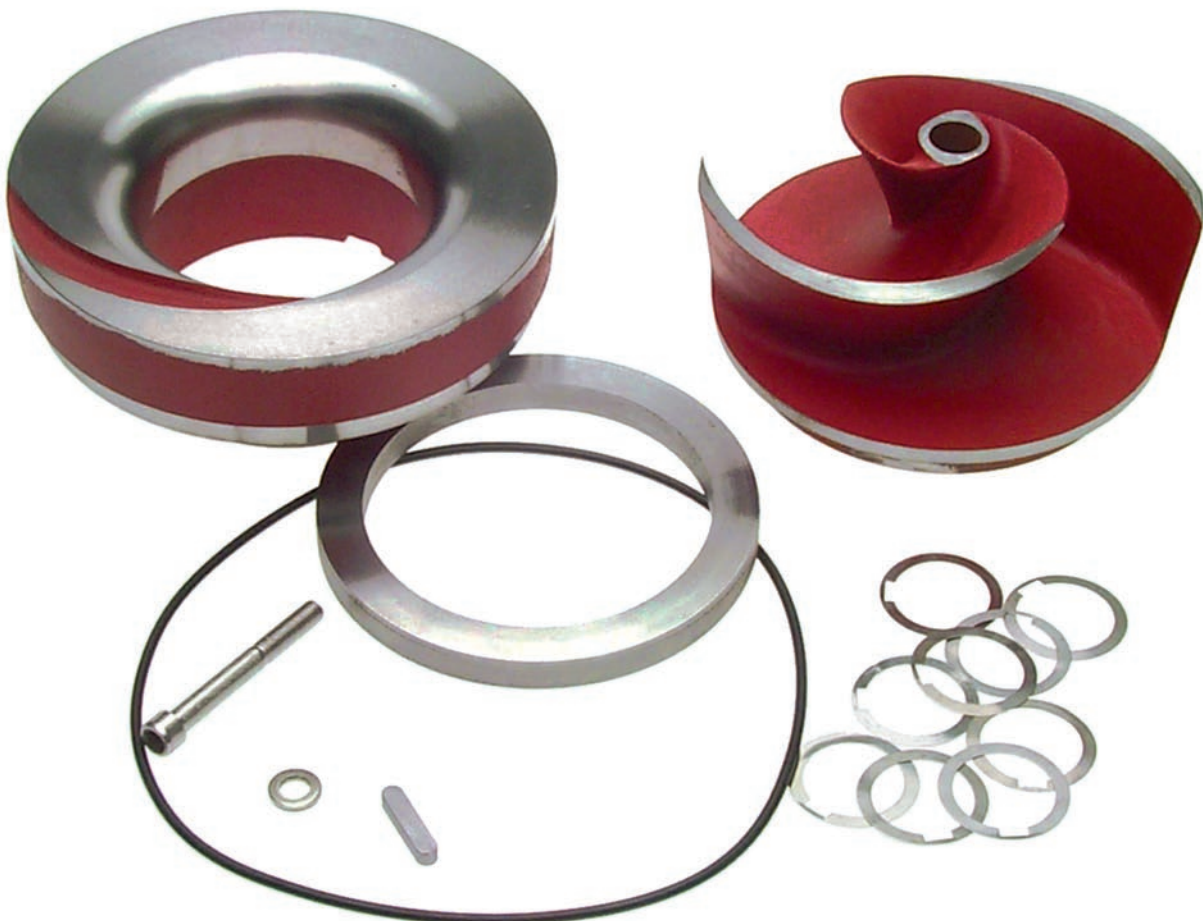

# World-wide service, world-class value

No two pumping stations or systems are alike, so the level of maintenance and support you require will differ from case to case. With Flygt, you can choose the type of support package that best matches your needs.

At one end, we help in selecting the right pump for a new application. At the other end, we can provide full service assistance that includes everything from system planning and design, through construction and commissioning, to operation and maintenance.

With a world-wide network of authorised service centres, you always get the support you need: whether it's

a question of planned maintenance, or express delivery of a part.

At Flygt, our driving force is always to minimise the life-cycle costs of the equipment and systems we supply.

## **20-year spare parts guarantee**

We guarantee the availability of spare parts for large N-pumps for 20 years after we stop production of the range. This is just one way in which we demonstrate long-term commitment to our customers.



As a leading supplier of fluid handling solutions, Flygt can supply everything you need to design, build and operate pump systems in a safe and cost-effective way.

Our products are used in water supply, wastewater treatment, sewage systems, mines, construction, process industries and numerous other applications.

Flygt is represented in over 130 countries and has more than 40 sales companies around the world.



[www.flygt.com](http://www.flygt.com)

[www.motralec.com](http://www.motralec.com) / [service-commercial@motralec.com](mailto:service-commercial@motralec.com) / 01.39.97.65.10





N 3356/765

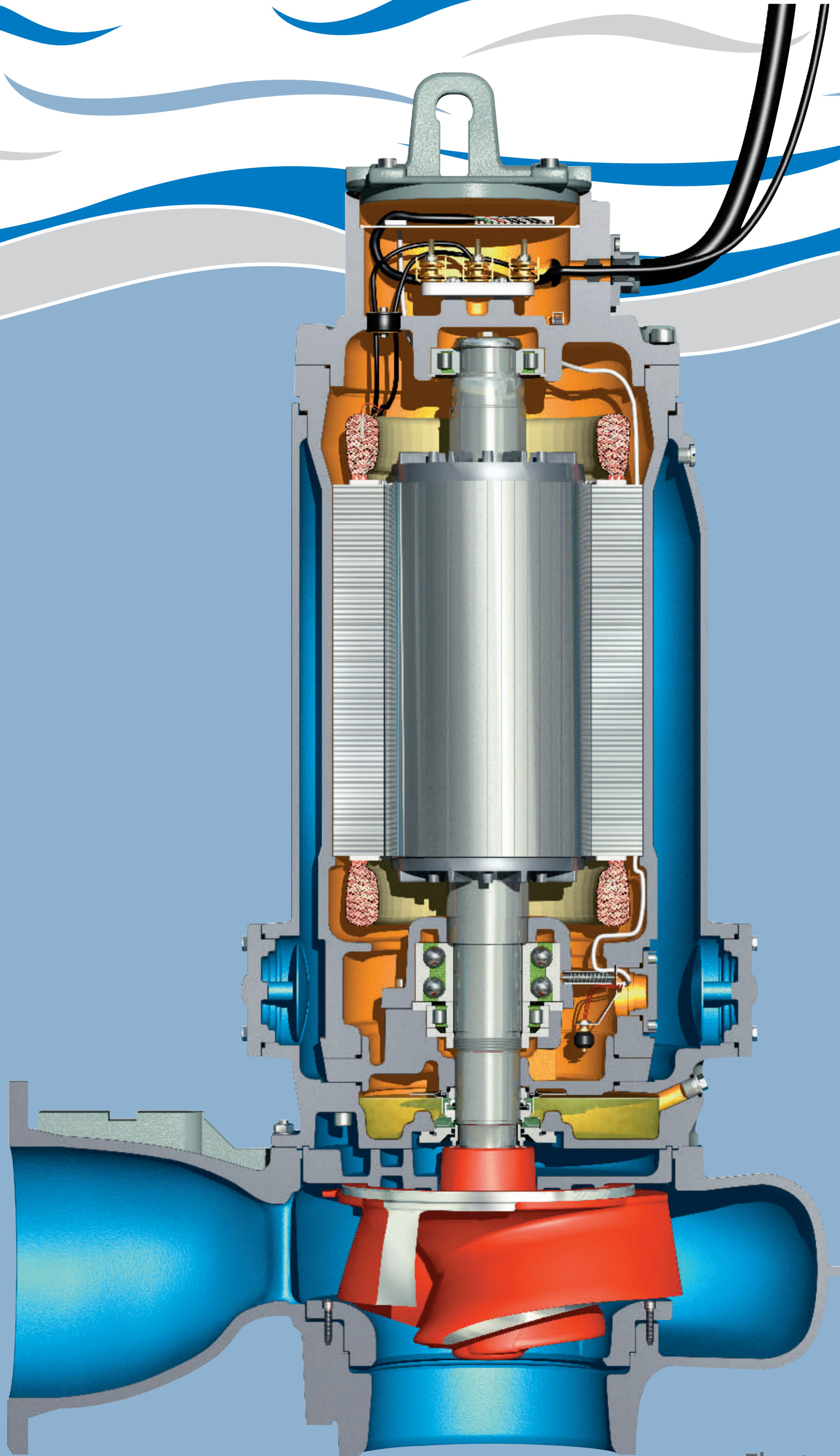

Flygt



ITT Industries  
*Engineered for life*



# PERFORMANCE FIELD

at Constant nominal speed

PROD.  
**N 3231**

DATE <b>2006-03-22</b>	ISSUE <b>3</b>	FREQ. <b>50 HZ</b>	NOMINAL HYDRAULIC-END SPEED <b>1490 RPM</b>	CURVE NO <b>53-470</b>
IMPELLER PART	PUMPHOUSING PART	INLET/OUTLET <b>250/200</b>	NO. OF BLADES <b>3</b>	AVAILABLE IMPELLER DIAMETERS EVERY 5 mm FROM 350 TO 490
DRIVE UNIT <b>605</b>	MOTOR <b>35-29-4AA</b>	POLES <b>4</b>	RATED POWER <b>70 kW</b>	RATED SPEED <b>RPM</b>
<b>665</b>	<b>35-35-4AA</b>	<b>4</b>	<b>85</b>	
<b>665</b>	<b>35-45-4AA</b>	<b>4</b>	<b>105</b>	
<b>705</b>	<b>43-30-4AA</b>	<b>4</b>	<b>125</b>	
<b>735</b>	<b>43-44-4AA</b>	<b>4</b>	<b>170</b>	
<b>765</b>	<b>43-56-4AA</b>	<b>4</b>	<b>215</b>	

## HEAD

ISO-CURVES :  
( — ) PUMP EFFICIENCY [%] and ( - . - . ) POWER LIMITS

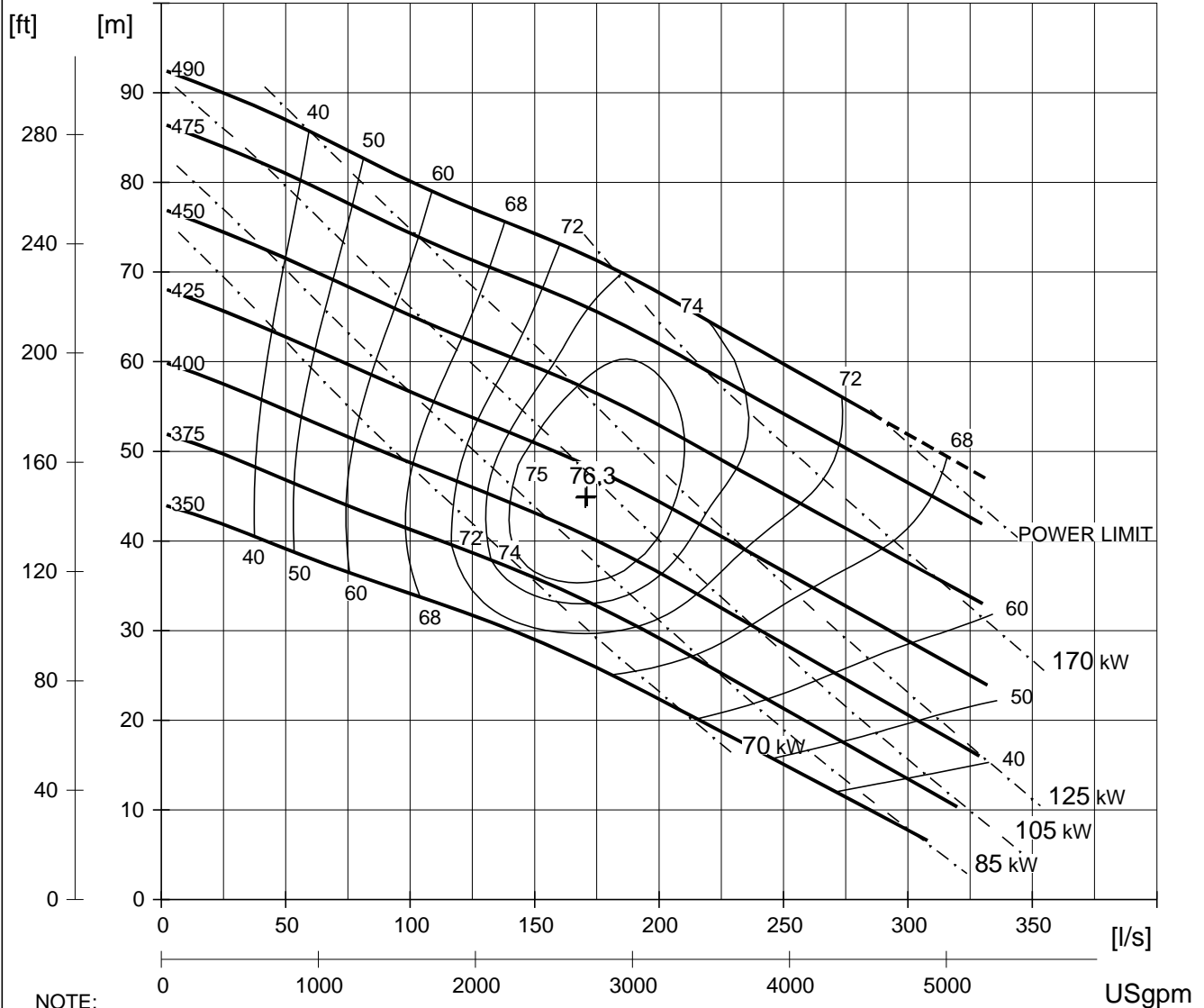

NOTE:  
CURVES ARE BASED ON NOMINAL CONSTANT HYDRAULIC-END SPEED.  
and SHOW PERFORMANCE WITH CLEAR COLD WATER.  
(NPSHR) = (NPSH3) + margins

### (NPSHR)

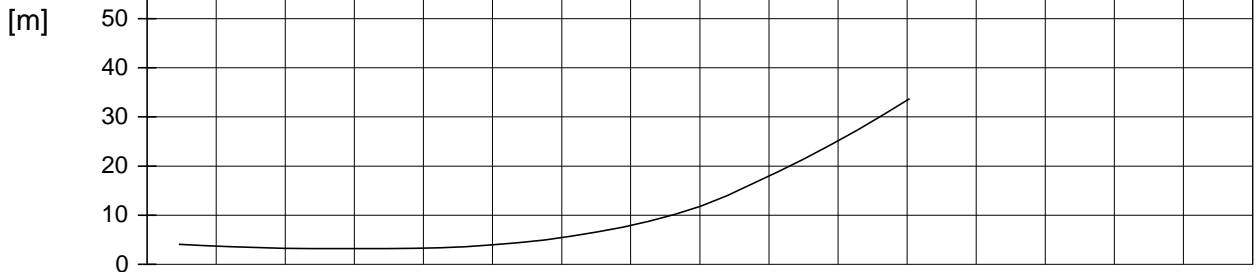

unix AUTHOR: FAS328 CUPF-C (rev.7.34)



# PERFORMANCE FIELD

at Constant nominal speed

PROD.  
**N 3306**

DATE <b>2006-03-22</b>	ISSUE <b>2</b>	FREQ. <b>50 HZ</b>	NOMINAL HYDRAULIC-END SPEED <b>990 RPM</b>	CURVE NO <b>53-670</b>
IMPELLER PART	PUMPHOUSING PART	INLET/OUTLET <b>300/300</b>	NO. OF BLADES <b>3</b>	AVAILABLE IMPELLER DIAMETERS EVERY 5 mm FROM 410 TO 475
DRIVE UNIT <b>605</b>	MOTOR <b>35-29-6AA</b>	POLES <b>6</b>	RATED POWER <b>58 kW</b>	RATED SPEED RPM
<b>665</b>	<b>35-35-6AA</b>	<b>6</b>	<b>75</b>	
<b>665</b>	<b>35-45-6AA</b>	<b>6</b>	<b>90</b>	
<b>705</b>	<b>43-30-6BC</b>	<b>6</b>	<b>100</b>	

## HEAD

ISO-CURVES :  
(——) PUMP EFFICIENCY [%] and (-.-.-) POWER LIMITS

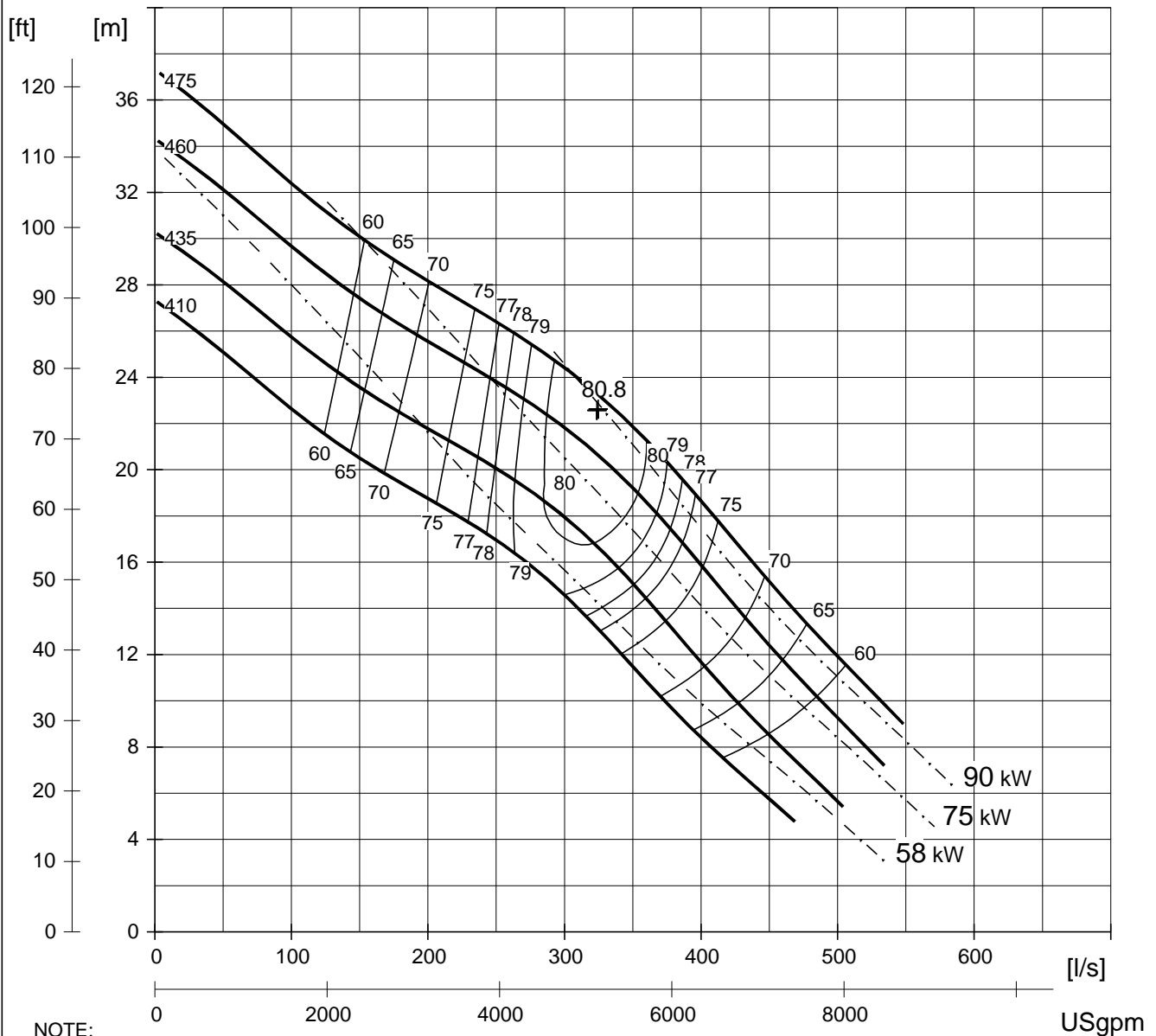

NOTE:  
CURVES ARE BASED ON NOMINAL CONSTANT HYDRAULIC-END SPEED.  
and SHOW PERFORMANCE WITH CLEAR COLD WATER.  
(NPSHR) = (NPSH3) + margins

### (NPSHR)

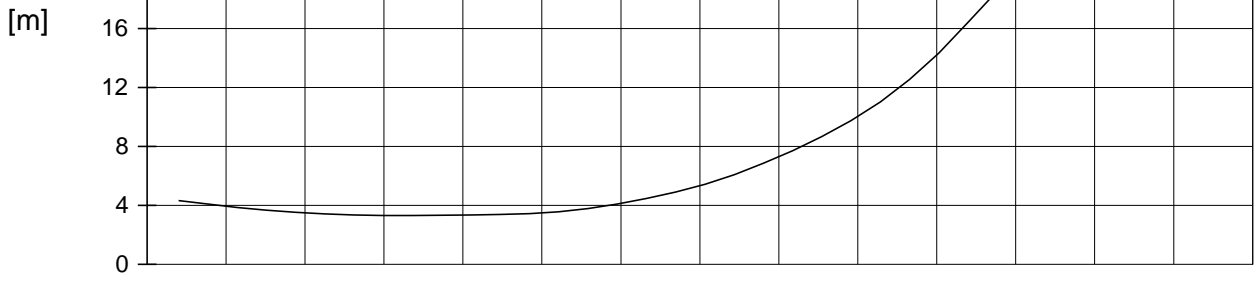

unix AUTHOR: FAS328 CUPF-C(rev:7.34)



# PERFORMANCE FIELD

at Constant nominal speed

PROD.  
**N 3312**

DATE <b>2006-03-22</b>	ISSUE <b>2</b>	FREQ. <b>50 HZ</b>	NOMINAL HYDRAULIC-END SPEED <b>995 RPM</b>	CURVE NO <b>53-670</b>
IMPELLER PART	PUMPHOUSING PART	INLET/OUTLET <b>350/300</b>	NO. OF BLADES <b>3</b>	AVAILABLE IMPELLER DIAMETERS EVERY 5 mm FROM 450 TO 585
DRIVE UNIT <b>705</b>	MOTOR <b>43-30-6BC</b>	POLES <b>6</b>	RATED POWER <b>100 kW</b>	RATED SPEED RPM
<b>735</b>	<b>43-44-6BC</b>	<b>6</b>	<b>140</b>	
<b>765</b>	<b>43-56-6BC</b>	<b>6</b>	<b>180</b>	
<b>835</b>	<b>54-52-6AA</b>	<b>6</b>	<b>250</b>	

## HEAD

ISO-CURVES :  
(——) PUMP EFFICIENCY [%] and (-.-.-) POWER LIMITS

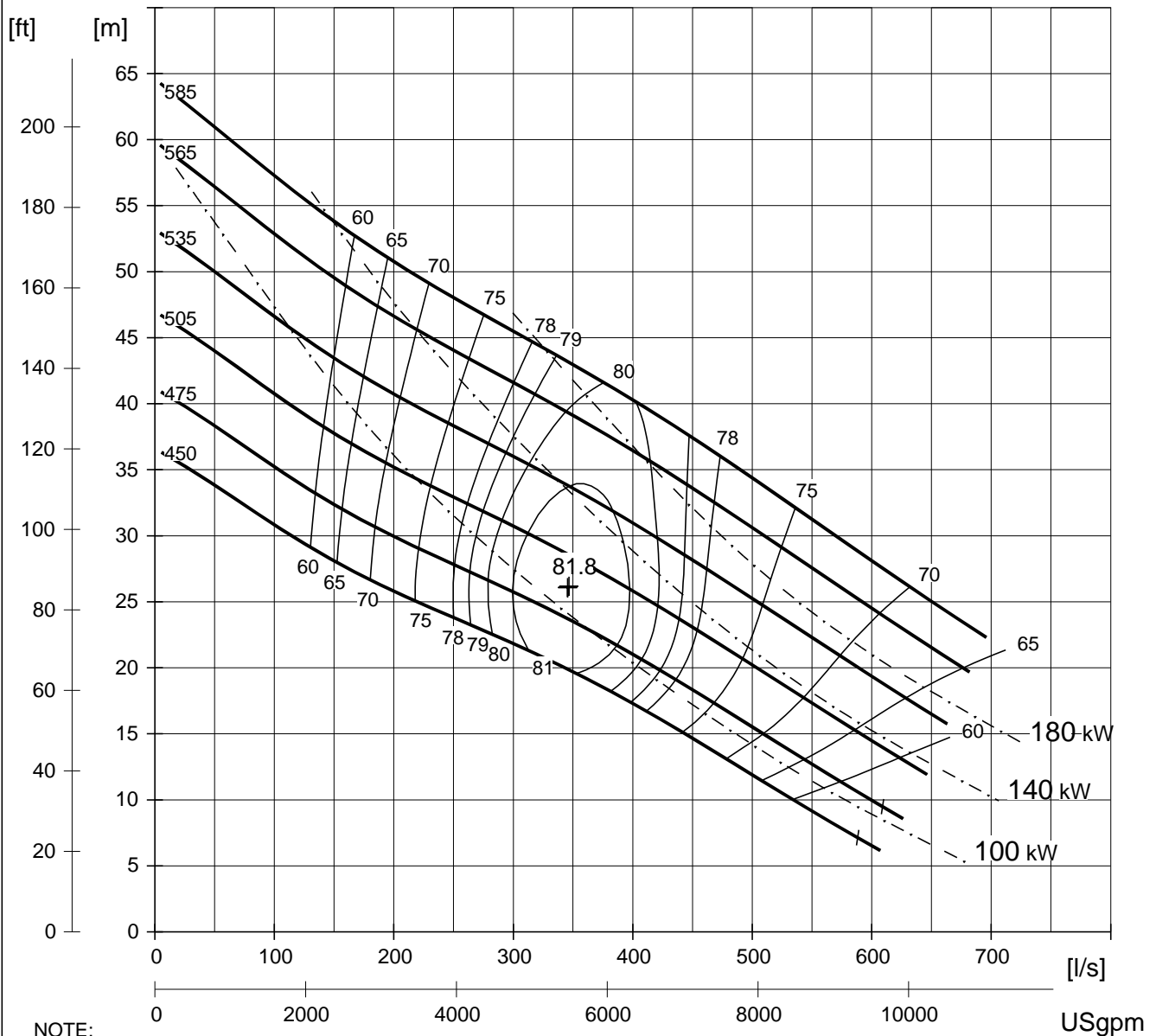

NOTE:  
CURVES ARE BASED ON NOMINAL CONSTANT HYDRAULIC-END SPEED.  
and SHOW PERFORMANCE WITH CLEAR COLD WATER.  
(NPSHR) = (NPSH3) + margins

## FLOW

### (NPSHR)

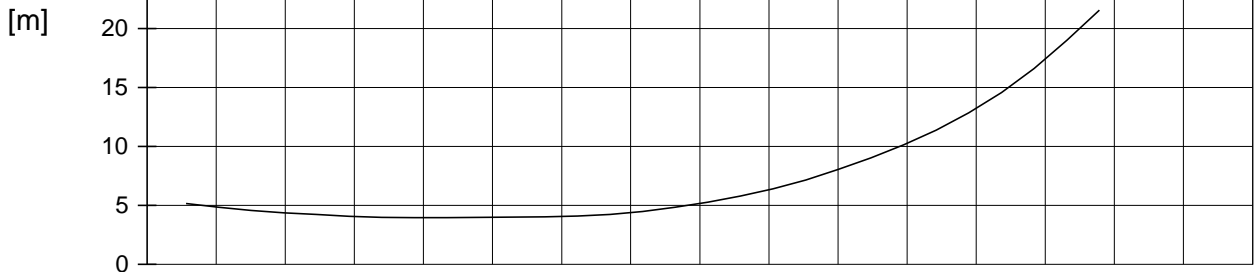

unix AUTHOR: FAS328 CUPF-C(rev:7.34)



# PERFORMANCE FIELD

at Constant nominal speed

PROD.

## N 3312

CURVE NO

### 53- 870

DATE 2006-03-22	ISSUE 1	FREQ. 50 HZ	NOMINAL HYDRAULIC-END SPEED 745 RPM	CURVE NO 53- 870	
IMPELLER PART	PUMPHOUSING PART	INLET/OUTLET 350/300		NO. OF BLADES 3	AVAILABLE IMPELLER DIAMETERS EVERY 5 mm FROM 450 TO 585
DRIVE UNIT 705	MOTOR 43-30-8FA		POLES 8	RATED POWER 55 kW	RATED SPEED RPM
705	43-30-8AA		8	90	
735	43-44-8AA		8	125	

## HEAD

ISO-CURVES :  
( ——— ) PUMP EFFICIENCY [%] and ( - . - . - ) POWER LIMITS

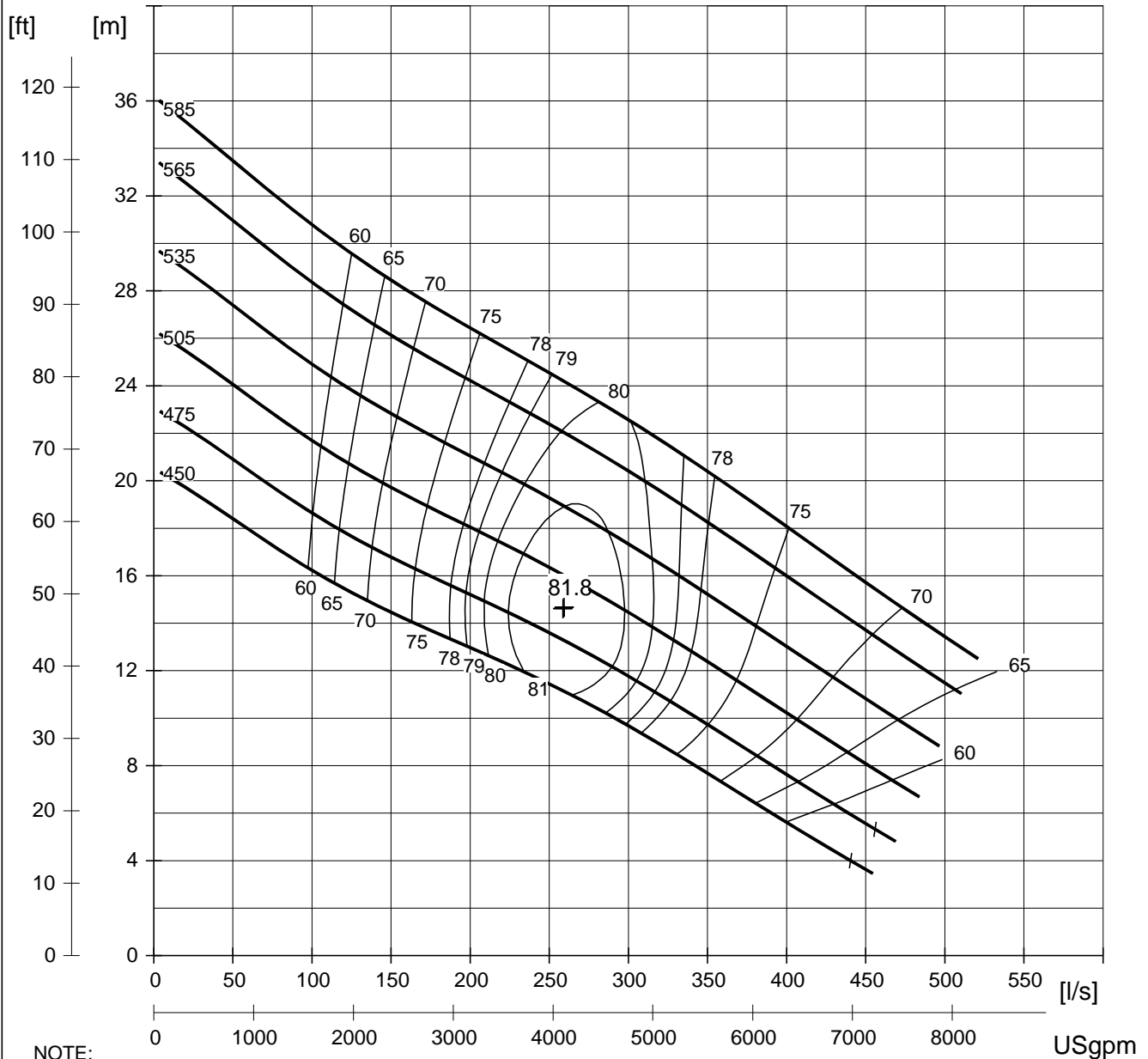

NOTE:

CURVES ARE BASED ON NOMINAL CONSTANT HYDRAULIC-END SPEED.  
and SHOW PERFORMANCE WITH CLEAR COLD WATER.

$$(NPSHR) = (NPSH3) + margins$$

(NPSHR)

[m]

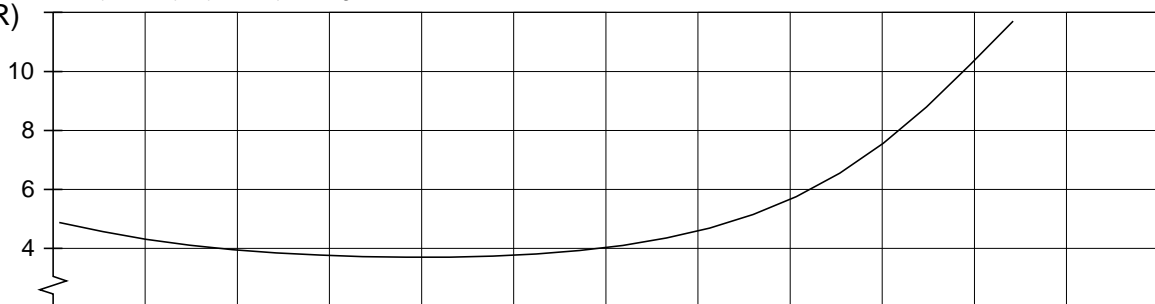

unix AUTHOR: FAS328 CUPF-C (rev:7.34)



# PERFORMANCE FIELD

at Constant nominal speed

PROD.  
**N 3356**

DATE <b>2006-03-22</b>	ISSUE <b>3</b>	FREQ. <b>50 HZ</b>	NOMINAL HYDRAULIC-END SPEED <b>990 RPM</b>		CURVE NO <b>53-670</b>
IMPELLER PART	PUMPHOUSING PART <b>692 35 00</b>	INLET/OUTLET <b>400/350</b>	NO. OF BLADES <b>3</b>		AVAILABLE IMPELLER DIAMETERS EVERY 5 mm FROM 370 TO 490
DRIVE UNIT <b>605</b>	MOTOR <b>35-29-6AA</b>	POLES <b>6</b>	RATED POWER <b>58 kW</b>		RATED SPEED <b>RPM</b>
<b>665</b>	<b>35-35-6AA</b>	<b>6</b>	<b>75</b>		
<b>665</b>	<b>35-45-6AA</b>	<b>6</b>	<b>90</b>		
<b>705</b>	<b>43-30-6BC</b>	<b>6</b>	<b>100</b>		
<b>735</b>	<b>43-44-6BC</b>	<b>6</b>	<b>140</b>		

## HEAD

ISO-CURVES :  
( ——— ) PUMP EFFICIENCY [%] and ( - . - . - ) POWER LIMITS

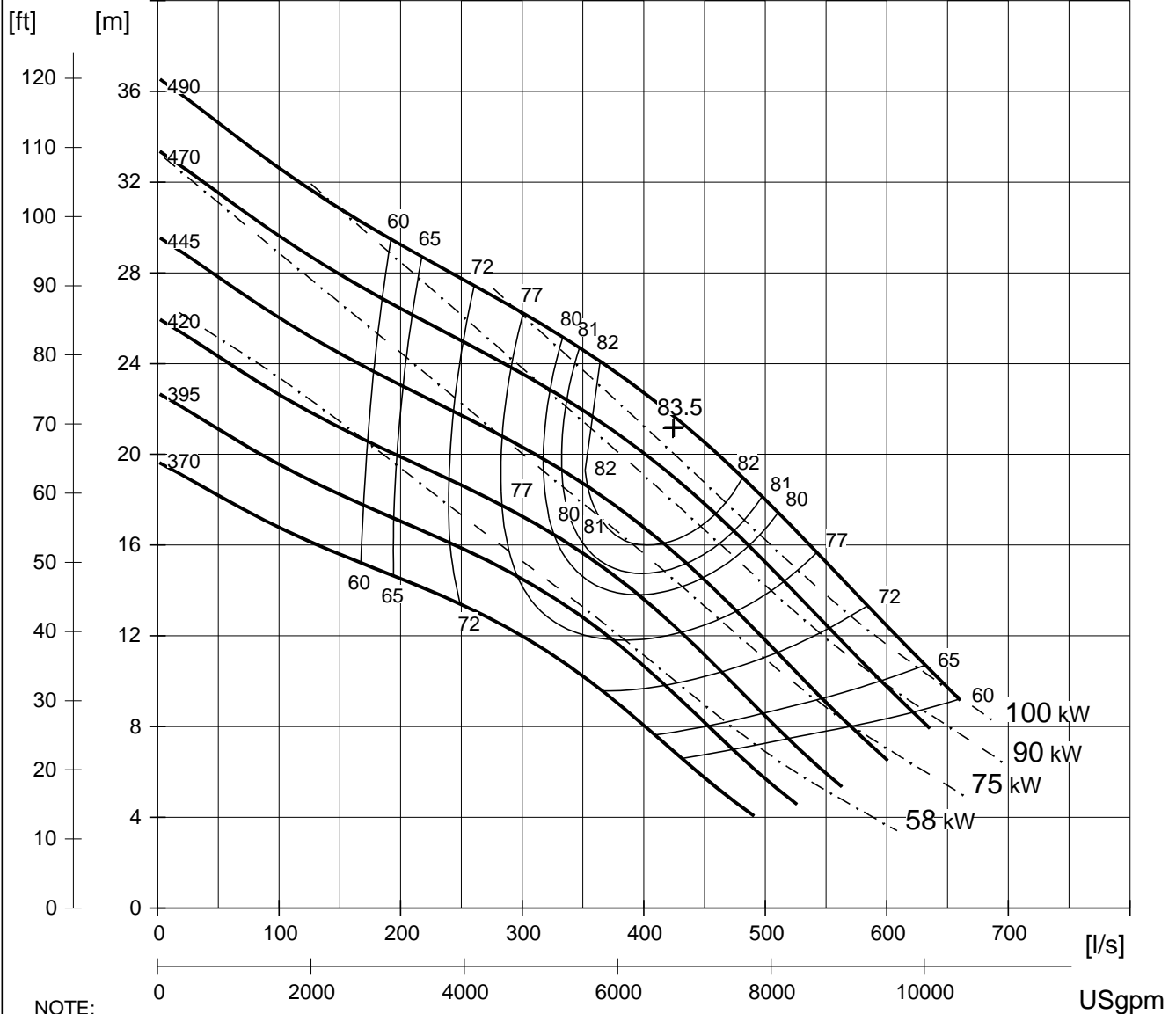

NOTE:  
CURVES ARE BASED ON NOMINAL CONSTANT HYDRAULIC-END SPEED.  
and SHOW PERFORMANCE WITH CLEAR COLD WATER.  
(NPSHR) = (NPSH3) + margins

## FLOW

### (NPSHR)

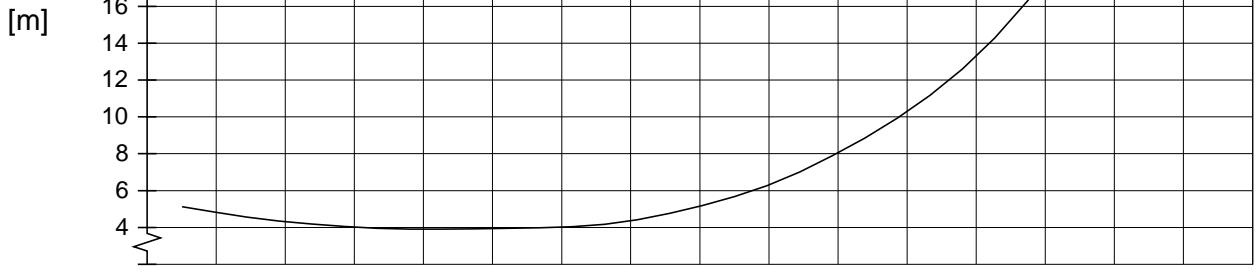

unix AUTHOR: FAS328 CUPF-C (rev:7.34)



# PERFORMANCE FIELD

at Constant nominal speed

PROD.

## N 3356

CURVE NO

### 53-870

DATE 2006-03-22	ISSUE 2	FREQ. 50 HZ	NOMINAL HYDRAULIC-END SPEED 745 RPM	
IMPELLER PART	PUMPHOUSING PART 692 35 00	INLET/OUTLET 400/350	NO. OF BLADES 3	AVAILABLE IMPELLER DIAMETERS EVERY 5 mm FROM 370 TO 490
DRIVE UNIT 605	MOTOR 35-29-8AA	POLES 8	RATED POWER 45 kW	RATED SPEED RPM
665	35-35-8AA	8	55	

## HEAD

ISO-CURVES :  
(——) PUMP EFFICIENCY [%] and (-.-.-) POWER LIMITS

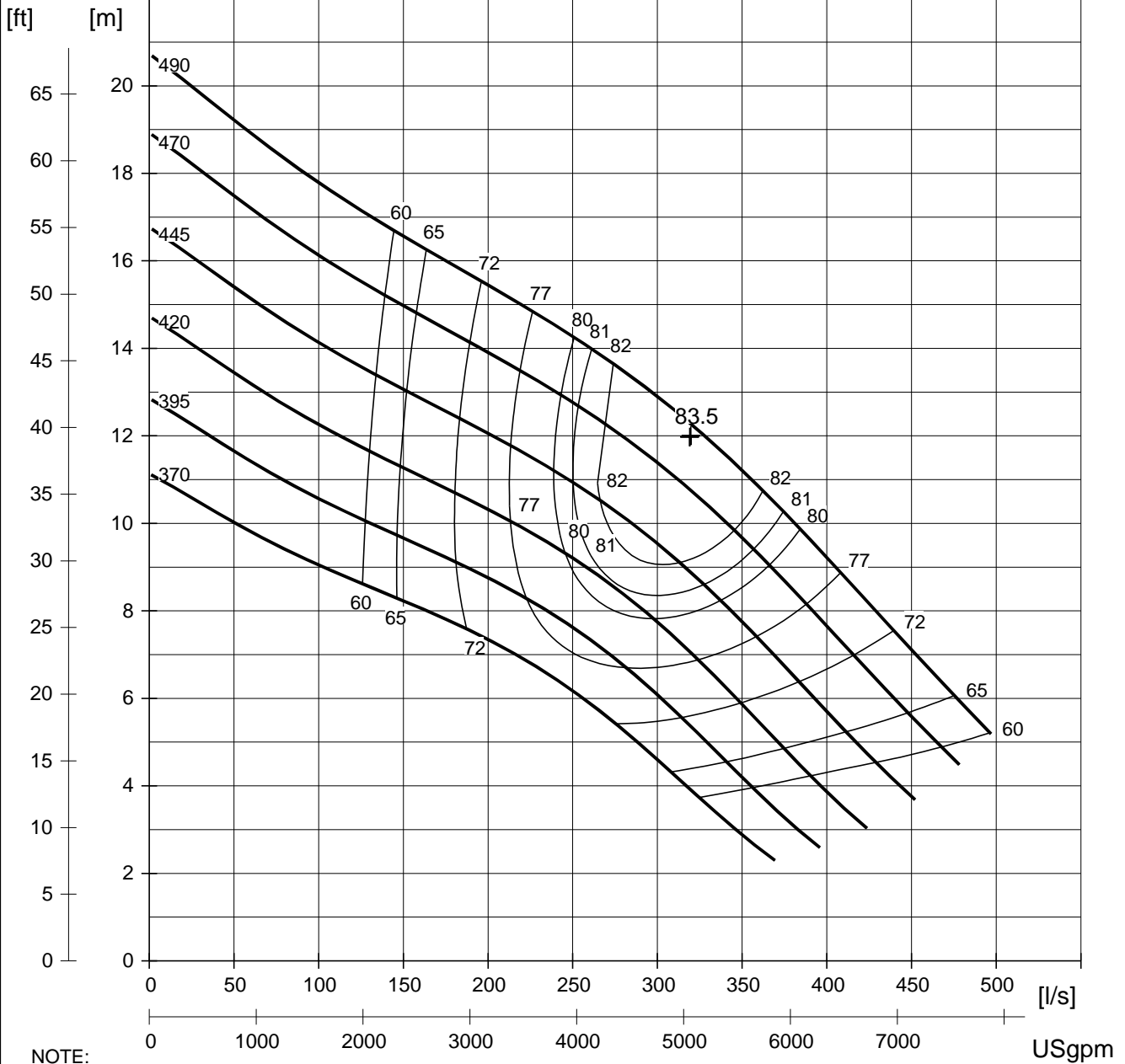

NOTE:  
CURVES ARE BASED ON NOMINAL CONSTANT HYDRAULIC-END SPEED.  
and SHOW PERFORMANCE WITH CLEAR COLD WATER.

$$(NPSHR) = (NPSH3) + margins$$

(NPSHR)

[m]

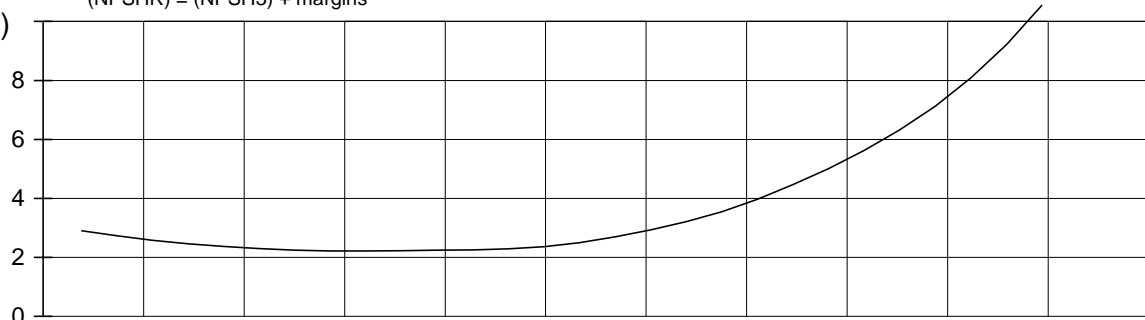

unix AUTHOR: FAS328 CUPF-C(rev:7.34)



# PERFORMANCE FIELD

at Constant nominal speed

PROD.  
**N 3400**

DATE <b>2006-03-22</b>	ISSUE <b>2</b>	FREQ. <b>50 HZ</b>	NOMINAL HYDRAULIC-END SPEED <b>990 RPM</b>	CURVE NO <b>53-670</b>
IMPELLER PART	PUMPHOUSING PART	INLET/OUTLET <b>500/400</b>	NO. OF BLADES <b>3</b>	AVAILABLE IMPELLER DIAMETERS EVERY 5 mm FROM 470 TO 585
DRIVE UNIT <b>735</b>	MOTOR <b>43-44-6BC</b>	POLES <b>6</b>	RATED POWER <b>140 kW</b>	RATED SPEED RPM
<b>805</b>	<b>54-38-6AA</b>	<b>6</b>	<b>180</b>	
<b>835</b>	<b>54-52-6AA</b>	<b>6</b>	<b>250</b>	
<b>865</b>	<b>54-66-6AA</b>	<b>6</b>	<b>310</b>	

## HEAD

ISO-CURVES :  
( ——— ) PUMP EFFICIENCY [%] and ( - . - . - ) POWER LIMITS

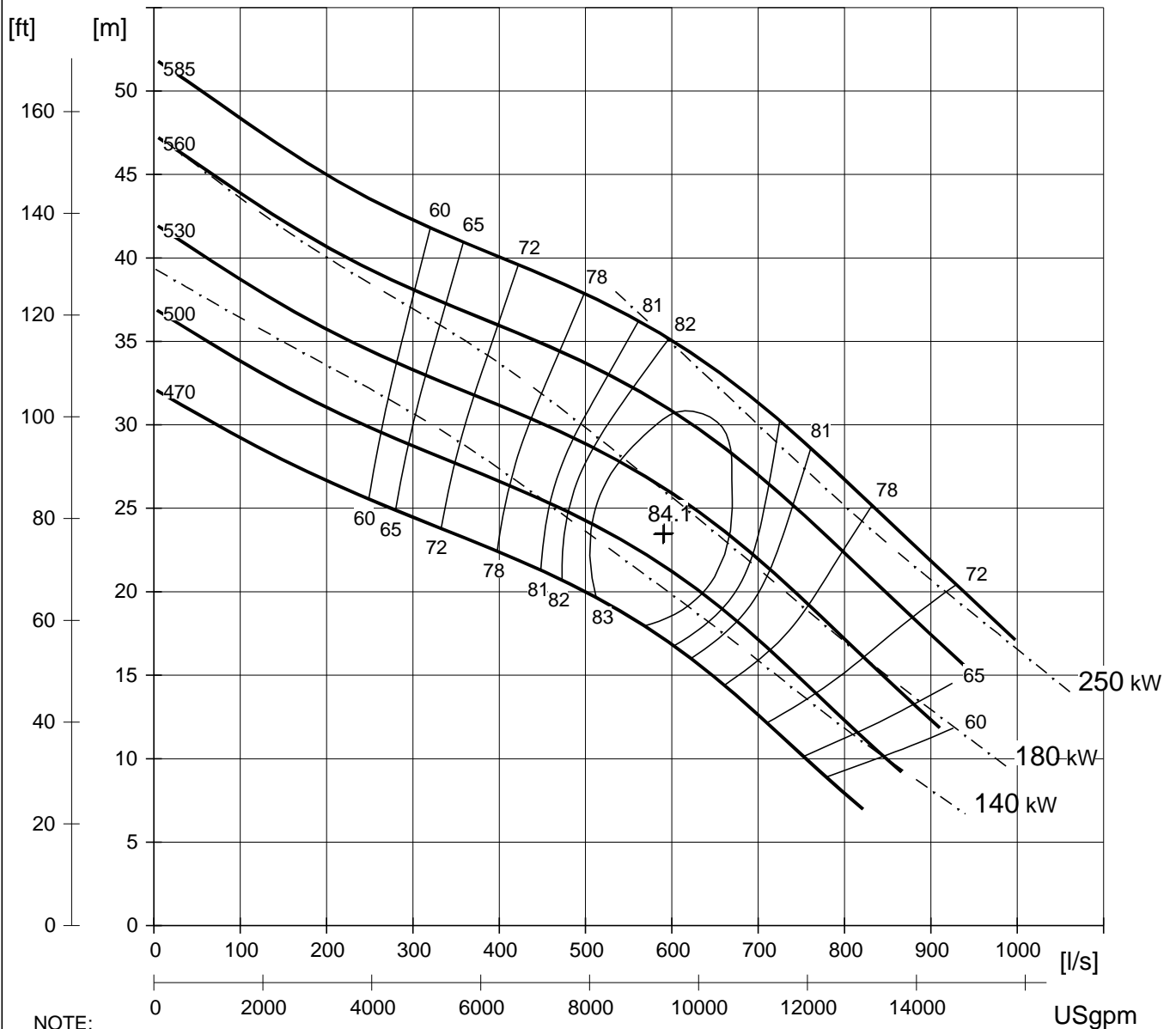

NOTE:  
CURVES ARE BASED ON NOMINAL CONSTANT HYDRAULIC-END SPEED.  
and SHOW PERFORMANCE WITH CLEAR COLD WATER.  
(NPSHR) = (NPSH3) + margins

### (NPSHR)



unix AUTHOR: FAS328 CUPF-C (rev:7.34)





# PERFORMANCE FIELD

at Constant nominal speed

PROD.  
**N 3400**

DATE <b>2006-03-22</b>	ISSUE <b>2</b>	FREQ. <b>50 HZ</b>	NOMINAL HYDRAULIC-END SPEED <b>745 RPM</b>	CURVE NO <b>53-870</b>
IMPELLER PART	PUMPHOUSING PART	INLET/OUTLET <b>500/400</b>	NO. OF BLADES <b>3</b>	AVAILABLE IMPELLER DIAMETERS EVERY 5 mm FROM 470 TO 585
DRIVE UNIT <b>705</b>	MOTOR <b>43-30-8FA</b>	POLES <b>8</b>	RATED POWER <b>55 kW</b>	RATED SPEED RPM
<b>705</b>	<b>43-30-8AA</b>	<b>8</b>	<b>90</b>	
<b>735</b>	<b>43-44-8AA</b>	<b>8</b>	<b>125</b>	

## HEAD

ISO-CURVES :  
( ——— ) PUMP EFFICIENCY [%] and ( - . - . - ) POWER LIMITS

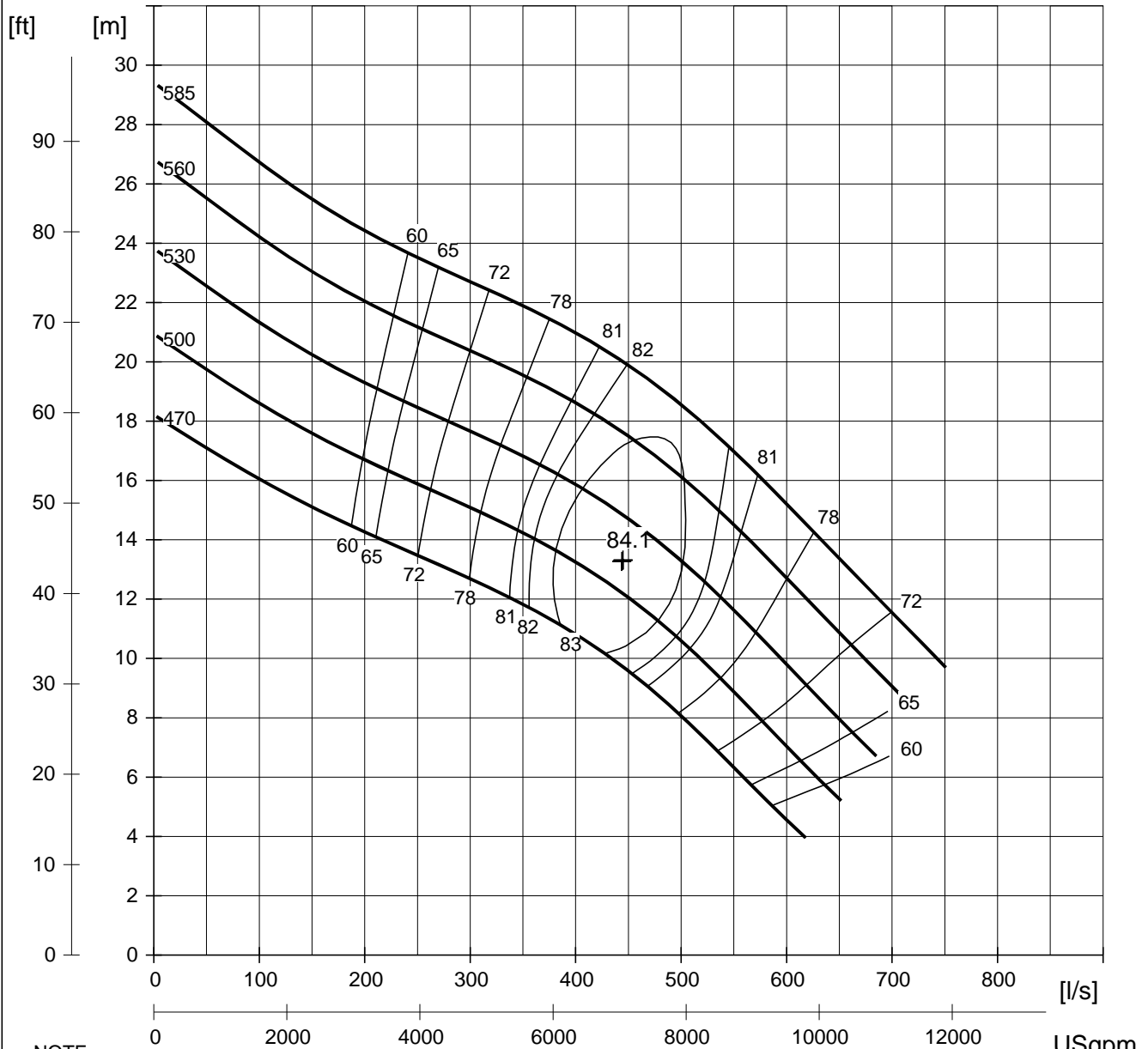

NOTE:  
CURVES ARE BASED ON NOMINAL CONSTANT HYDRAULIC-END SPEED.  
and SHOW PERFORMANCE WITH CLEAR COLD WATER.  
(NPSHR) = (NPSH3) + margins

## FLOW

### (NPSHR)

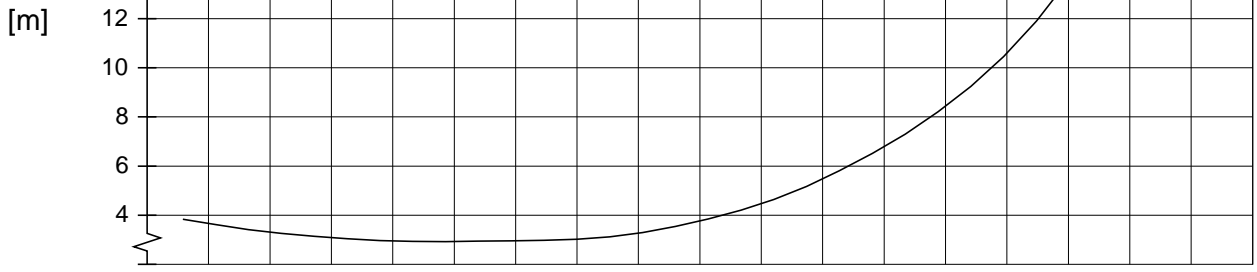

unix AUTHOR: FAS328 CUPF-C (rev:7.34)



# PERFORMANCE FIELD

at Constant nominal speed

PROD.  
**N 3400**

DATE <b>2006-03-22</b>	ISSUE <b>2</b>	FREQ. <b>50 HZ</b>	NOMINAL HYDRAULIC-END SPEED <b>595 RPM</b>		CURVE NO <b>53- 1070</b>
IMPELLER PART	PUMPHOUSING PART	INLET/OUTLET <b>500/400</b>		NO. OF BLADES <b>3</b>	AVAILABLE IMPELLER DIAMETERS EVERY 5 mm FROM 470 TO 585
DRIVE UNIT <b>705</b>	MOTOR <b>43-30-10FA</b>	POLES <b>10</b>	RATED POWER <b>40 kW</b>		RATED SPEED RPM
<b>705</b>	<b>43-30-10GA</b>	<b>10</b>	<b>60</b>		

## HEAD

ISO-CURVES :  
( ——— ) PUMP EFFICIENCY [%] and ( - . - . - ) POWER LIMITS

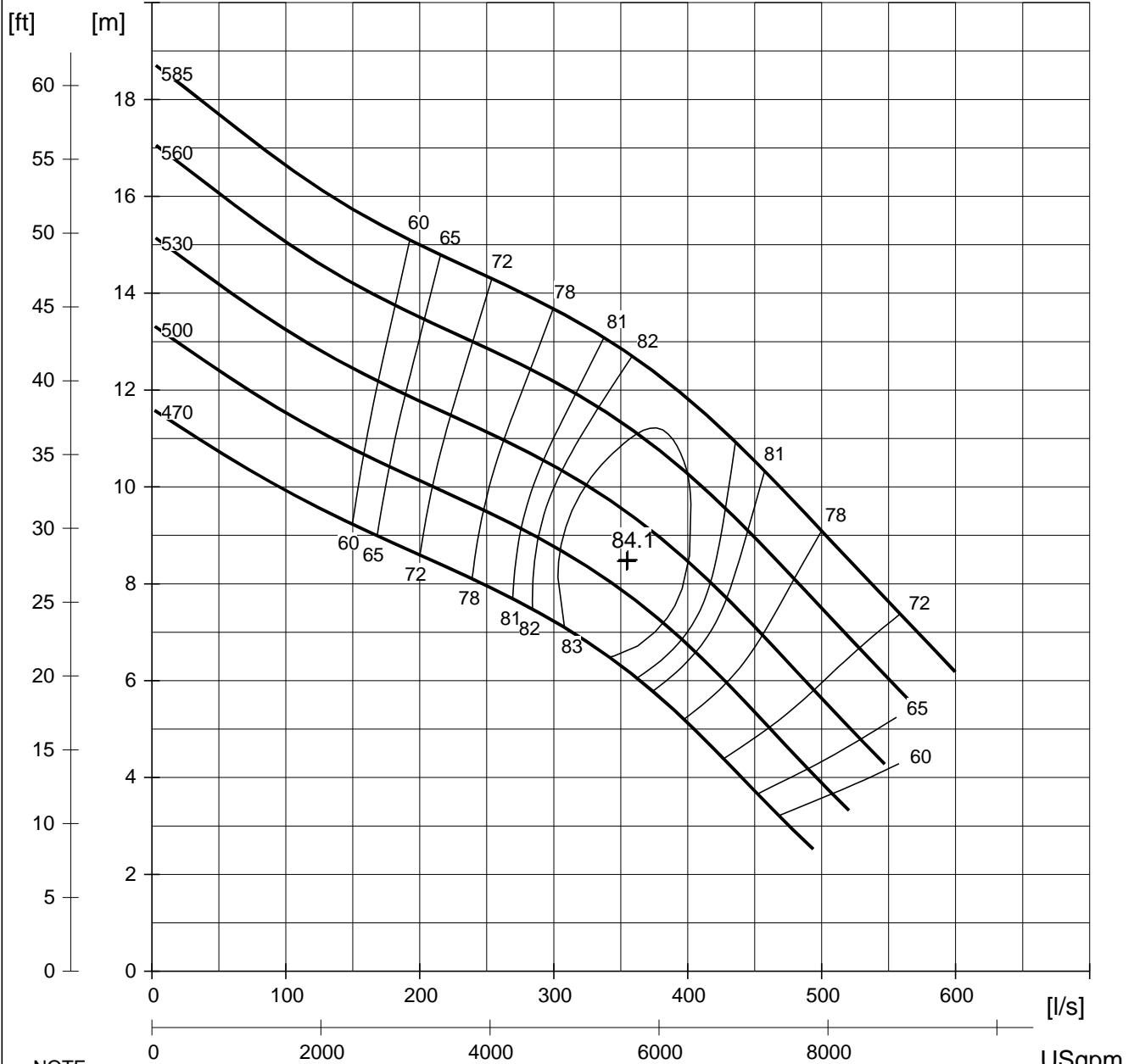

NOTE:  
CURVES ARE BASED ON NOMINAL CONSTANT HYDRAULIC-END SPEED.  
and SHOW PERFORMANCE WITH CLEAR COLD WATER.  
(NPSHR) = (NPSH3) + margins

## (NPSHR)

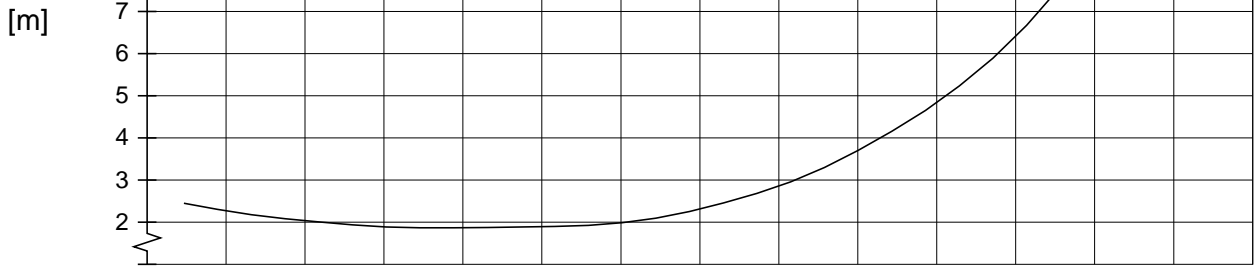

unix AUTHOR: FAS328 CUPF-C (rev:7.34)



# PERFORMANCE FIELD

at Constant nominal speed

PROD.  
**N 3400**

CURVE NO  
**53- 1270**

DATE <b>2006-03-22</b>	ISSUE <b>2</b>	FREQ. <b>50 HZ</b>	NOMINAL HYDRAULIC-END SPEED <b>495 RPM</b>	
IMPELLER PART	PUMPHOUSING PART	INLET/OUTLET <b>500/400</b>	NO. OF BLADES <b>3</b>	AVAILABLE IMPELLER DIAMETERS EVERY 5 mm FROM 470 TO 585
DRIVE UNIT <b>705</b>	MOTOR <b>43-30-12FA</b>	POLES <b>12</b>	RATED POWER <b>30 kW</b>	RATED SPEED RPM
<b>705</b>	<b>43-30-12AA</b>	<b>12</b>	<b>40</b>	

## HEAD

ISO-CURVES :  
(——) PUMP EFFICIENCY [%] and (-.-.-) POWER LIMITS

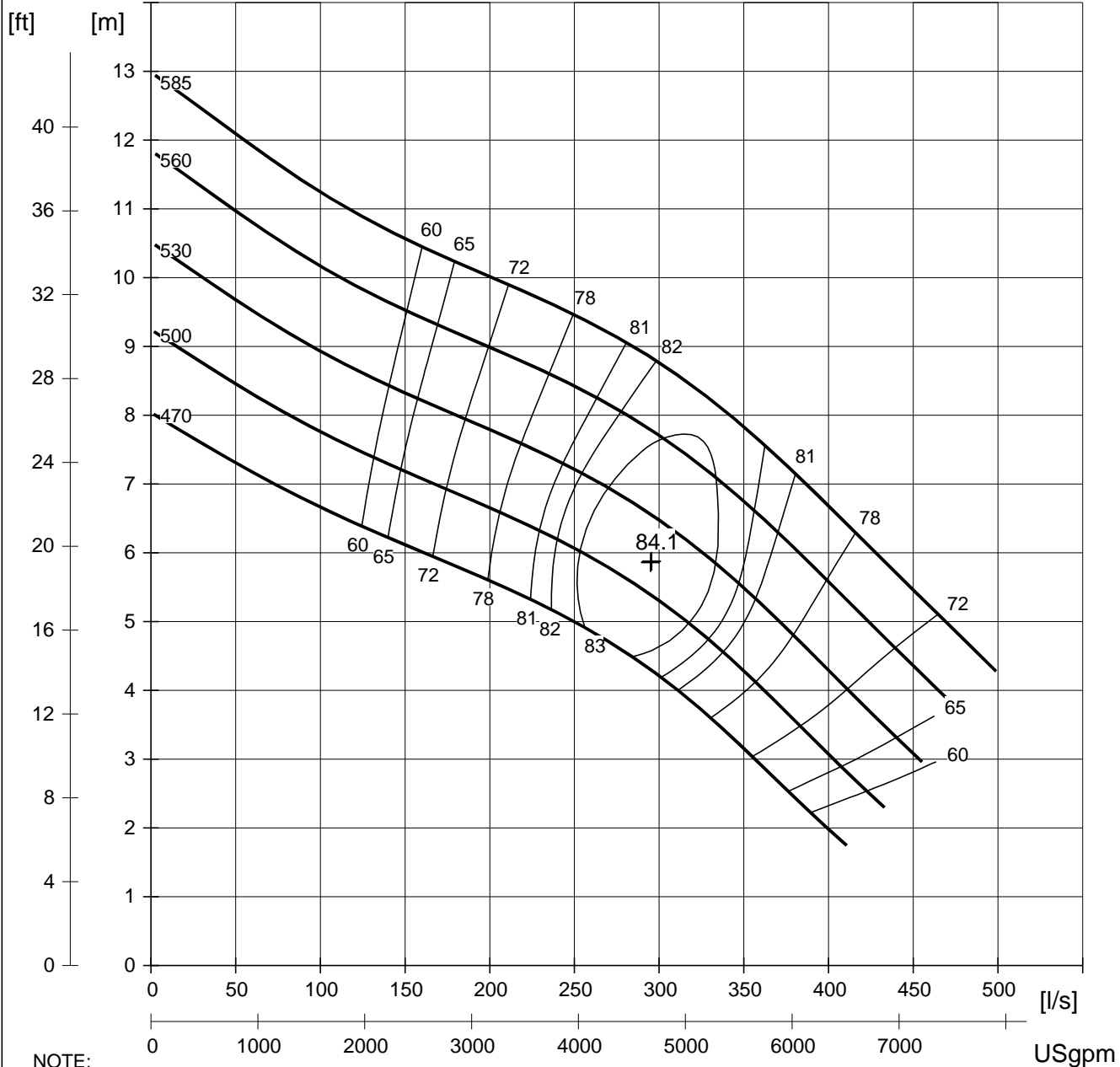

NOTE:  
CURVES ARE BASED ON NOMINAL CONSTANT HYDRAULIC-END SPEED.  
and SHOW PERFORMANCE WITH CLEAR COLD WATER.  
(NPSHR) = (NPSH3) + margins

### (NPSHR)

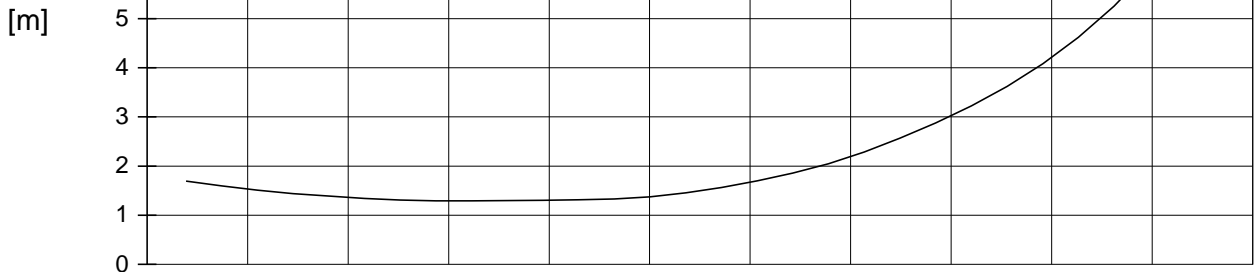

unix AUTHOR: FAS328 CUPF-C (rev:7.34)



# PERFORMANCE FIELD

at Constant nominal speed

PROD.  
**N 3231**

DATE <b>2006-03-22</b>	ISSUE <b>3</b>	FREQ. <b>60 HZ</b>	NOMINAL HYDRAULIC-END SPEED <b>1790 RPM</b>	CURVE NO <b>63-470</b>
IMPELLER PART	PUMPHOUSING PART	INLET/OUTLET <b>250/200</b>	NO. OF BLADES <b>3</b>	AVAILABLE IMPELLER DIAMETERS EVERY 5 mm FROM 350 TO 470
DRIVE UNIT <b>665</b>	MOTOR <b>35-35-4AA</b>	POLES <b>4</b>	RATED POWER <b>130 HP /97 kW</b>	RATED SPEED RPM
<b>665</b>	<b>35-45-4AA</b>	<b>4</b>	<b>160 HP /119 kW</b>	
<b>705</b>	<b>43-30-4AA</b>	<b>4</b>	<b>185 HP /138 kW</b>	
<b>735</b>	<b>43-44-4AA</b>	<b>4</b>	<b>250 HP /186 kW</b>	
<b>765</b>	<b>43-56-4AA</b>	<b>4</b>	<b>335 HP /250 kW</b>	

## HEAD

ISO-CURVES :  
( — ) PUMP EFFICIENCY [%] and ( - . - . ) POWER LIMITS

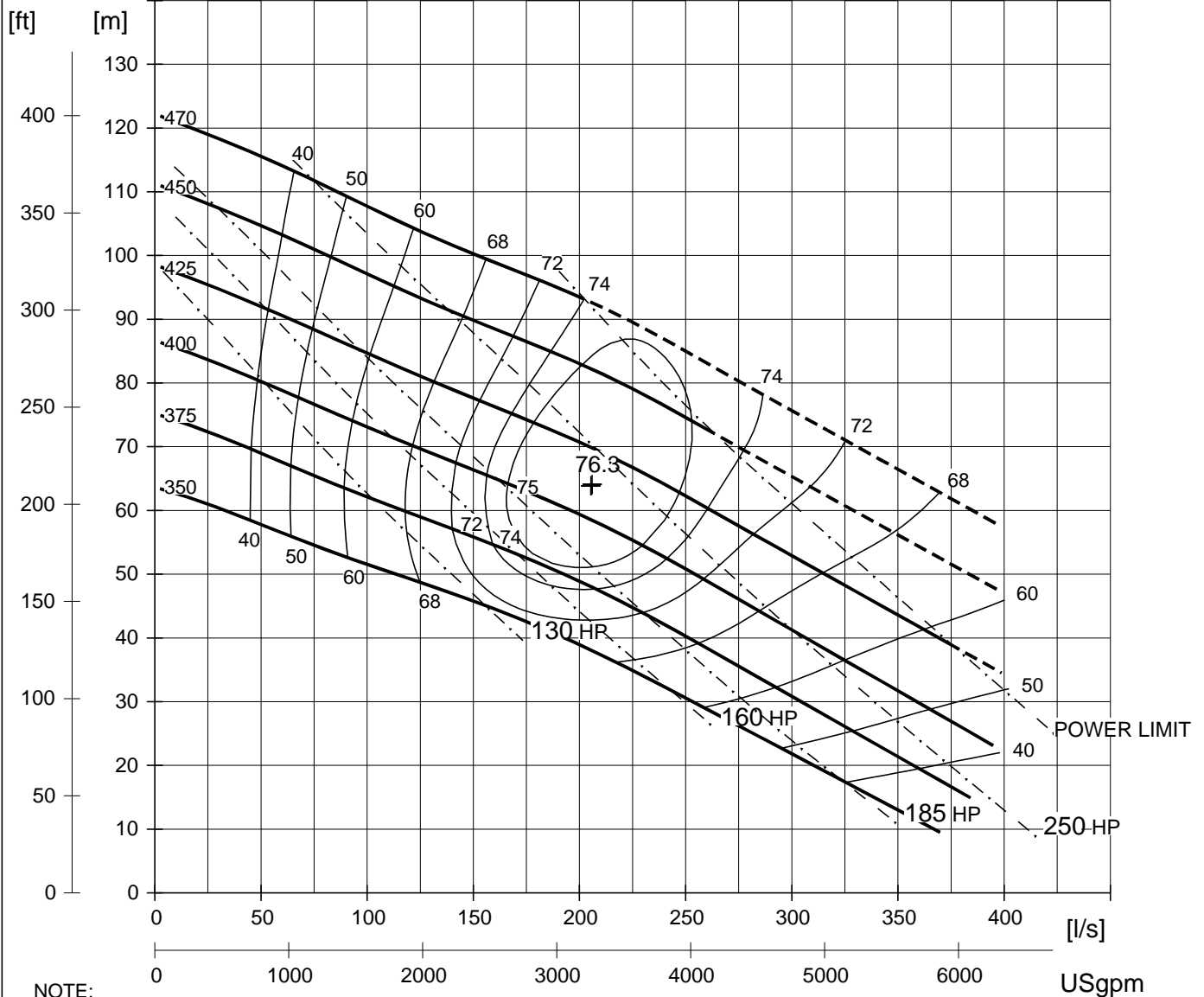

NOTE:  
CURVES ARE BASED ON NOMINAL CONSTANT HYDRAULIC-END SPEED.  
and SHOW PERFORMANCE WITH CLEAR COLD WATER.  
(NPSHR) = (NPSH3) + margins

## FLOW

### (NPSHR)

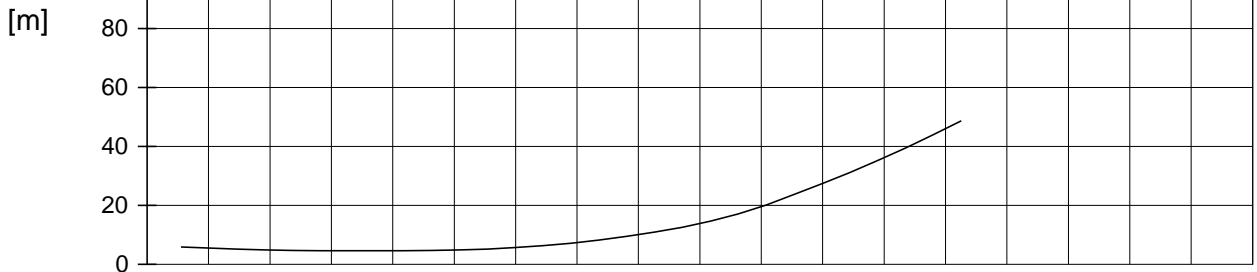

unix AUTHOR: FAS328 CUPF-C (rev:7.34)



# PERFORMANCE FIELD

at Constant nominal speed

PROD.

## N 3231

CURVE NO

### 63- 670

DATE <b>2006-03-22</b>	ISSUE <b>2</b>	FREQ. <b>60 HZ</b>	NOMINAL HYDRAULIC-END SPEED <b>1195 RPM</b>	
IMPELLER PART	PUMPHOUSING PART	INLET/OUTLET <b>250/200</b>	NO. OF BLADES <b>3</b>	AVAILABLE IMPELLER DIAMETERS EVERY 5 mm FROM 350 TO 490
DRIVE UNIT <b>605</b>	MOTOR <b>35-29-6AA</b>	POLES <b>6</b>	RATED POWER <b>90 HP /67 kW</b>	RATED SPEED RPM
<b>665</b>	<b>35-35-6AA</b>	<b>6</b>	<b>110 HP /82 kW</b>	
<b>665</b>	<b>35-45-6AA</b>	<b>6</b>	<b>140 HP /104 kW</b>	

## HEAD

ISO-CURVES :  
( ——— ) PUMP EFFICIENCY [%] and ( - . - . - ) POWER LIMITS

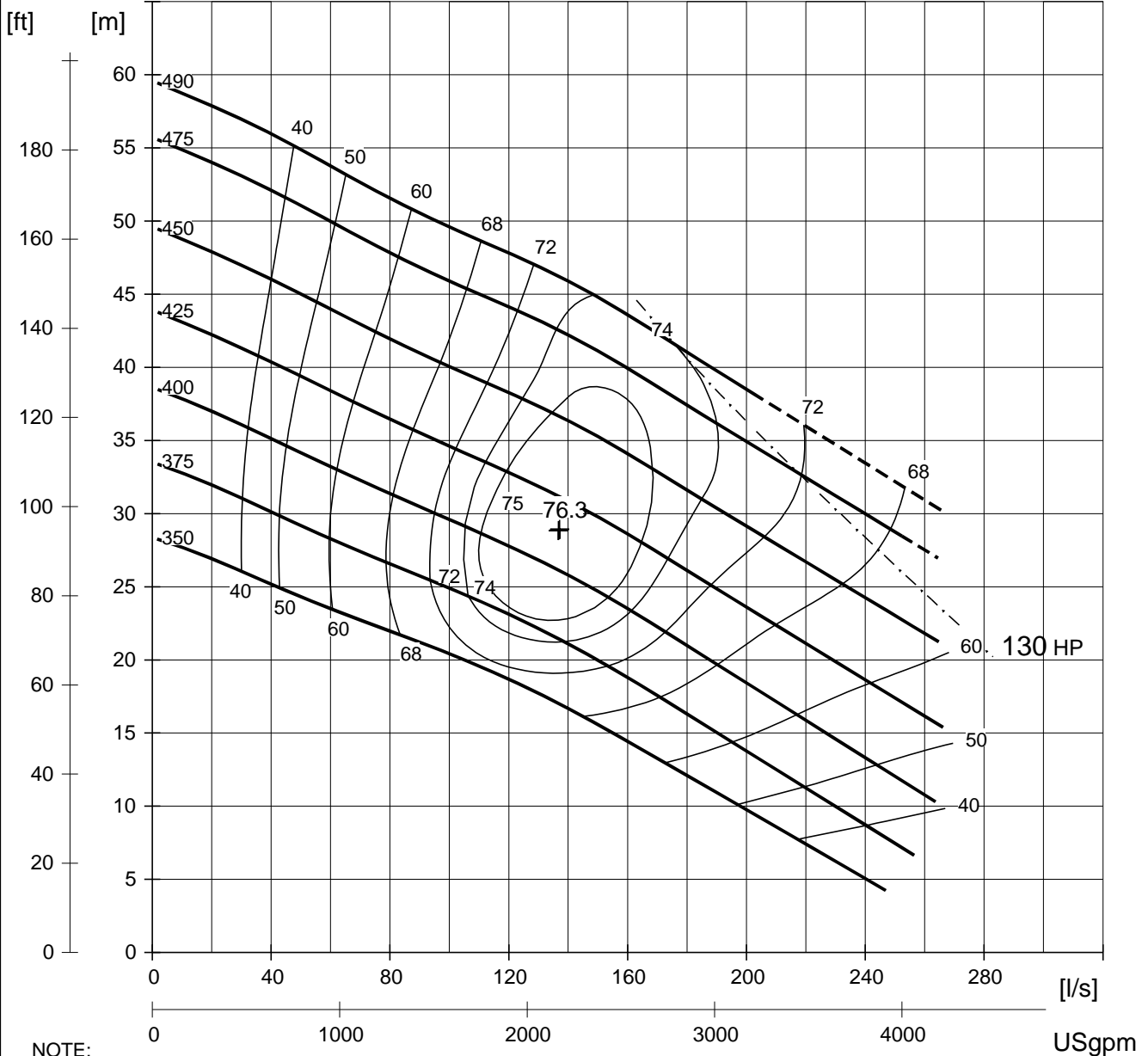

NOTE:  
CURVES ARE BASED ON NOMINAL CONSTANT HYDRAULIC-END SPEED.  
and SHOW PERFORMANCE WITH CLEAR COLD WATER.  
(NPSHR) = (NPSH3) + margins

## FLOW

(NPSHR)

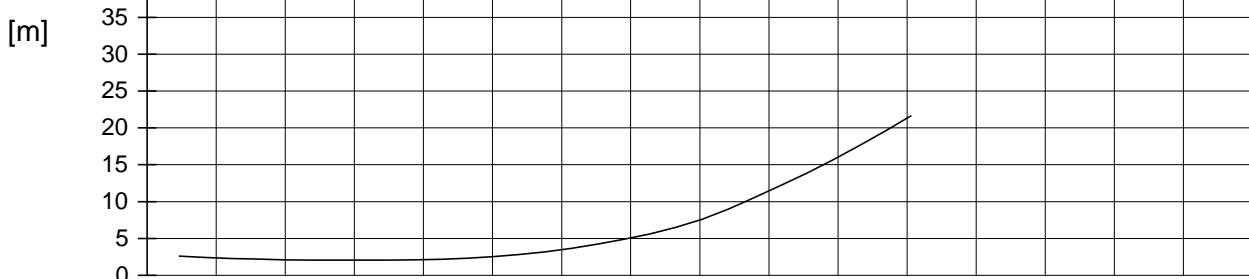

unix AUTHOR: FAS328 CUPF-C(rev:7.34)



# PERFORMANCE FIELD

at Constant nominal speed

PROD.  
**N 3306**

DATE <b>2006-03-22</b>	ISSUE <b>2</b>	FREQ. <b>60 HZ</b>	NOMINAL HYDRAULIC-END SPEED <b>1190 RPM</b>	CURVE NO <b>63- 670</b>
IMPELLER PART	PUMPHOUSING PART	INLET/OUTLET <b>300/300</b>	NO. OF BLADES <b>3</b>	AVAILABLE IMPELLER DIAMETERS EVERY 5 mm FROM 410 TO 475
DRIVE UNIT <b>665</b>	MOTOR <b>35-35-6AA</b>	POLES <b>6</b>	RATED POWER <b>110 HP /82 kW</b>	RATED SPEED RPM
<b>665</b>	<b>35-45-6AA</b>	<b>6</b>	<b>140 HP /104 kW</b>	
<b>705</b>	<b>43-30-6BC</b>	<b>6</b>	<b>150 HP /112 kW</b>	
<b>735</b>	<b>43-44-6BC</b>	<b>6</b>	<b>215 HP /160 kW</b>	
<b>765</b>	<b>43-56-6BC</b>	<b>6</b>	<b>280 HP /209 kW</b>	

## HEAD

ISO-CURVES :  
( — ) PUMP EFFICIENCY [%] and ( - . - . ) POWER LIMITS

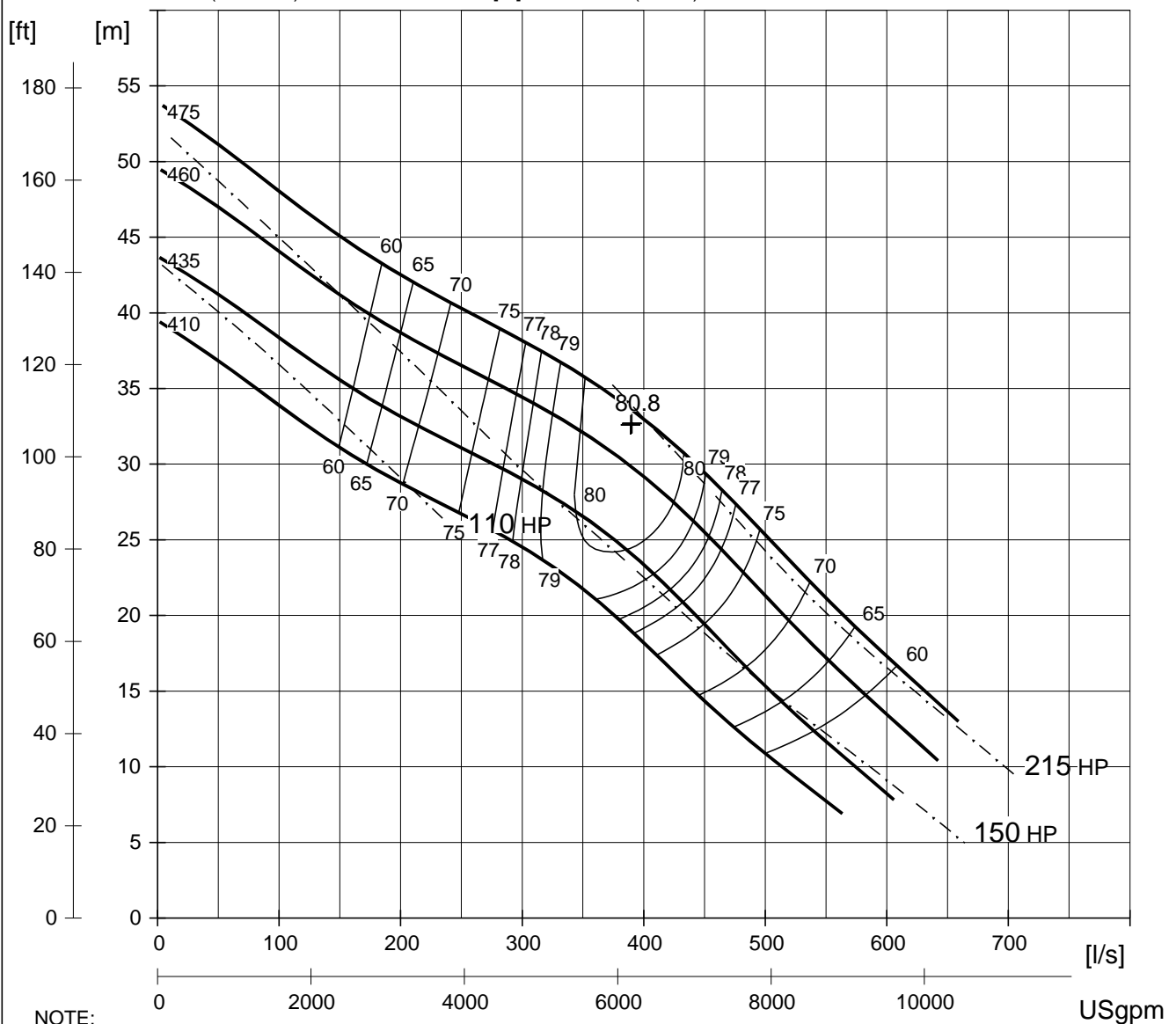

NOTE:  
CURVES ARE BASED ON NOMINAL CONSTANT HYDRAULIC-END SPEED.  
and SHOW PERFORMANCE WITH CLEAR COLD WATER.  
(NPSHR) = (NPSH3) + margins

## FLOW

### (NPSHR)

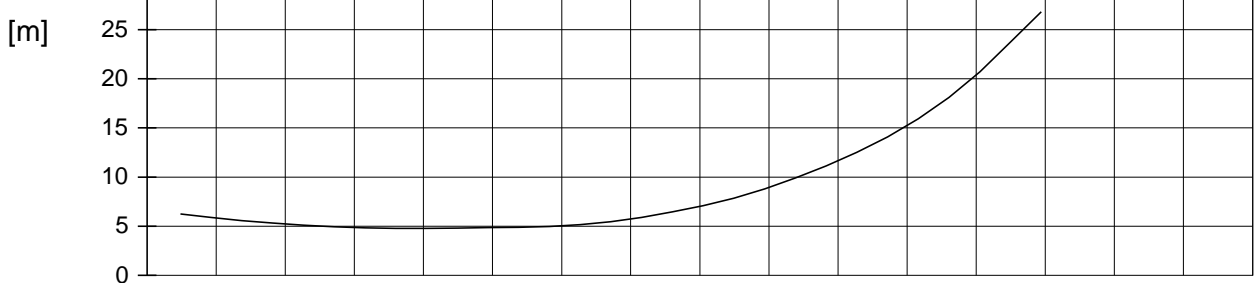

unix AUTHOR: FAS328 CUPF-C(rev:7.34)



# PERFORMANCE FIELD

at Constant nominal speed

PROD.  
**N 3306**

DATE <b>2006-03-22</b>	ISSUE <b>2</b>	FREQ. <b>60 HZ</b>	NOMINAL HYDRAULIC-END SPEED <b>895 RPM</b>	CURVE NO <b>63- 870</b>
IMPELLER PART	PUMPHOUSING PART	INLET/OUTLET <b>300/300</b>	NO. OF BLADES <b>3</b>	AVAILABLE IMPELLER DIAMETERS EVERY 5 mm FROM 410 TO 475
DRIVE UNIT <b>605</b>	MOTOR <b>35-29-8AA</b>	POLES <b>8</b>	RATED POWER <b>70 HP /52 kW</b>	RATED SPEED RPM
<b>665</b>	<b>35-35-8AA</b>	<b>8</b>	<b>85 HP /63 kW</b>	
<b>665</b>	<b>35-45-8AA</b>	<b>8</b>	<b>100 HP /75 kW</b>	

## HEAD

ISO-CURVES :  
( ——— ) PUMP EFFICIENCY [%] and ( - . - . - ) POWER LIMITS

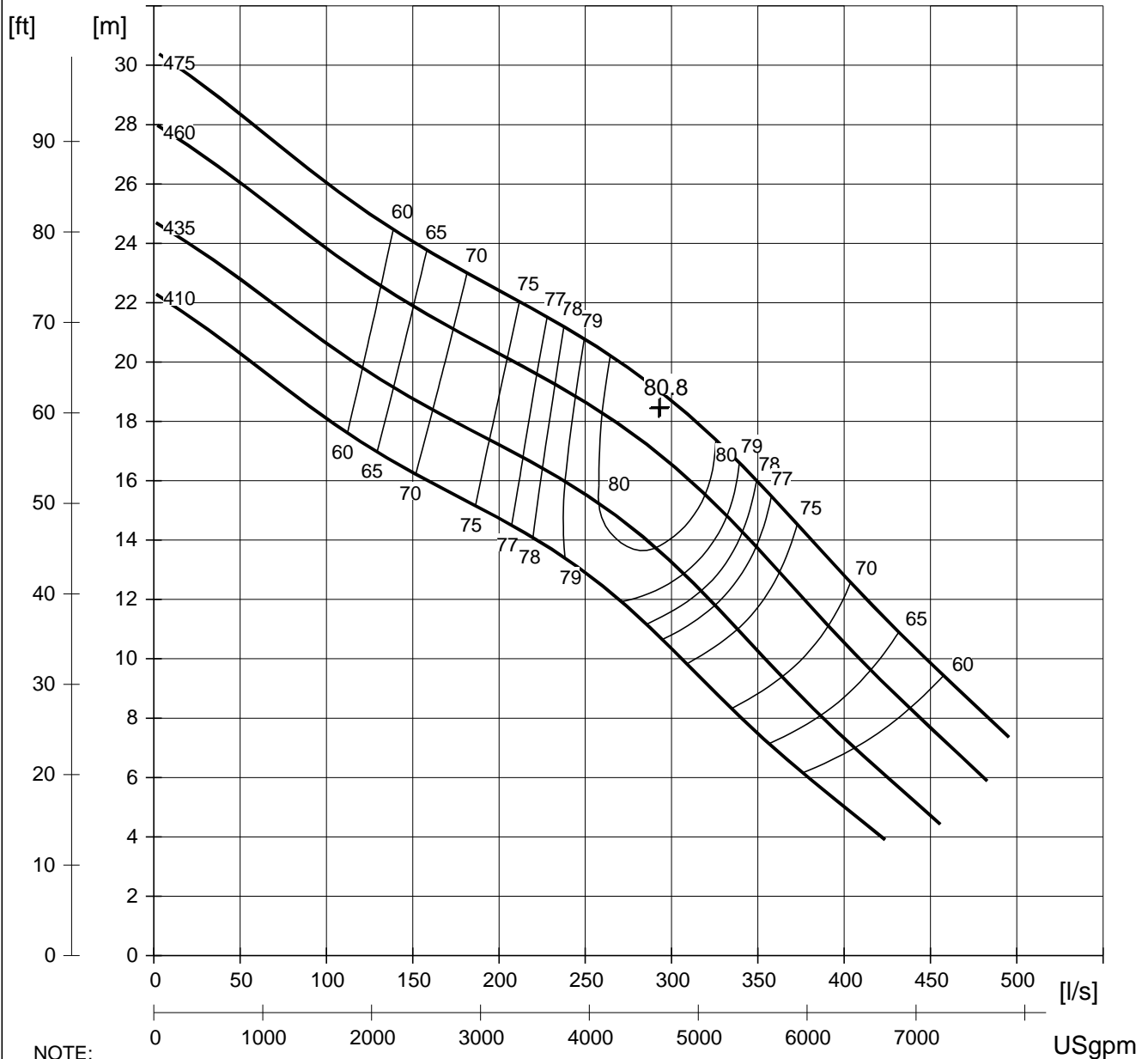

NOTE:  
CURVES ARE BASED ON NOMINAL CONSTANT HYDRAULIC-END SPEED.  
and SHOW PERFORMANCE WITH CLEAR COLD WATER.  
(NPSHR) = (NPSH3) + margins

## FLOW

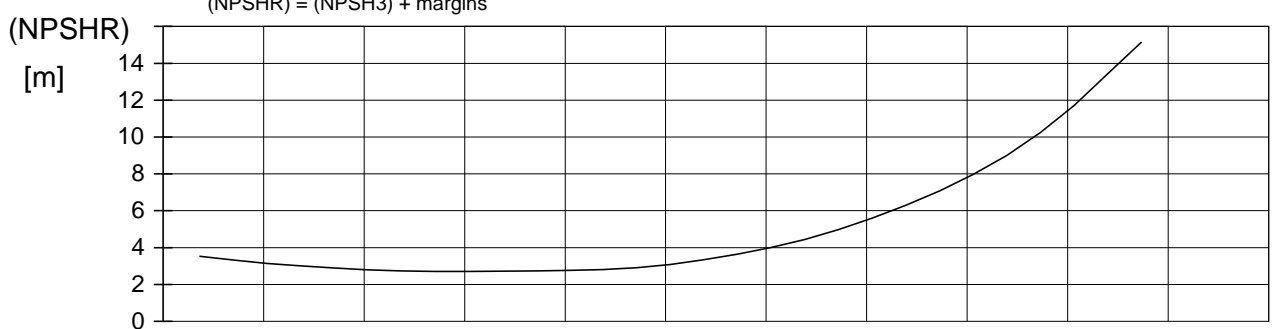

unix AUTHOR: FAS328 CUPF-C(rev:7.34)



# PERFORMANCE FIELD

at Constant nominal speed

PROD.  
**N 3312**

DATE <b>2006-03-22</b>	ISSUE <b>2</b>	FREQ. <b>60 HZ</b>	NOMINAL HYDRAULIC-END SPEED <b>1195 RPM</b>	CURVE NO <b>63-670</b>
IMPELLER PART	PUMPHOUSING PART	INLET/OUTLET <b>350/300</b>	NO. OF BLADES <b>3</b>	AVAILABLE IMPELLER DIAMETERS EVERY 5 mm FROM 450 TO 585
DRIVE UNIT <b>735</b>	MOTOR <b>43-44-6BC</b>	POLES <b>6</b>	RATED POWER <b>215 HP /160 kW</b>	RATED SPEED RPM
<b>765</b>	<b>43-56-6BC</b>	<b>6</b>	<b>280 HP /209 kW</b>	
<b>835</b>	<b>54-52-6AA</b>	<b>6</b>	<b>385 HP /287 kW</b>	
<b>865</b>	<b>54-66-6AA</b>	<b>6</b>	<b>470 HP /350 kW</b>	

## HEAD

ISO-CURVES :  
(——) PUMP EFFICIENCY [%] and (-.-.-) POWER LIMITS

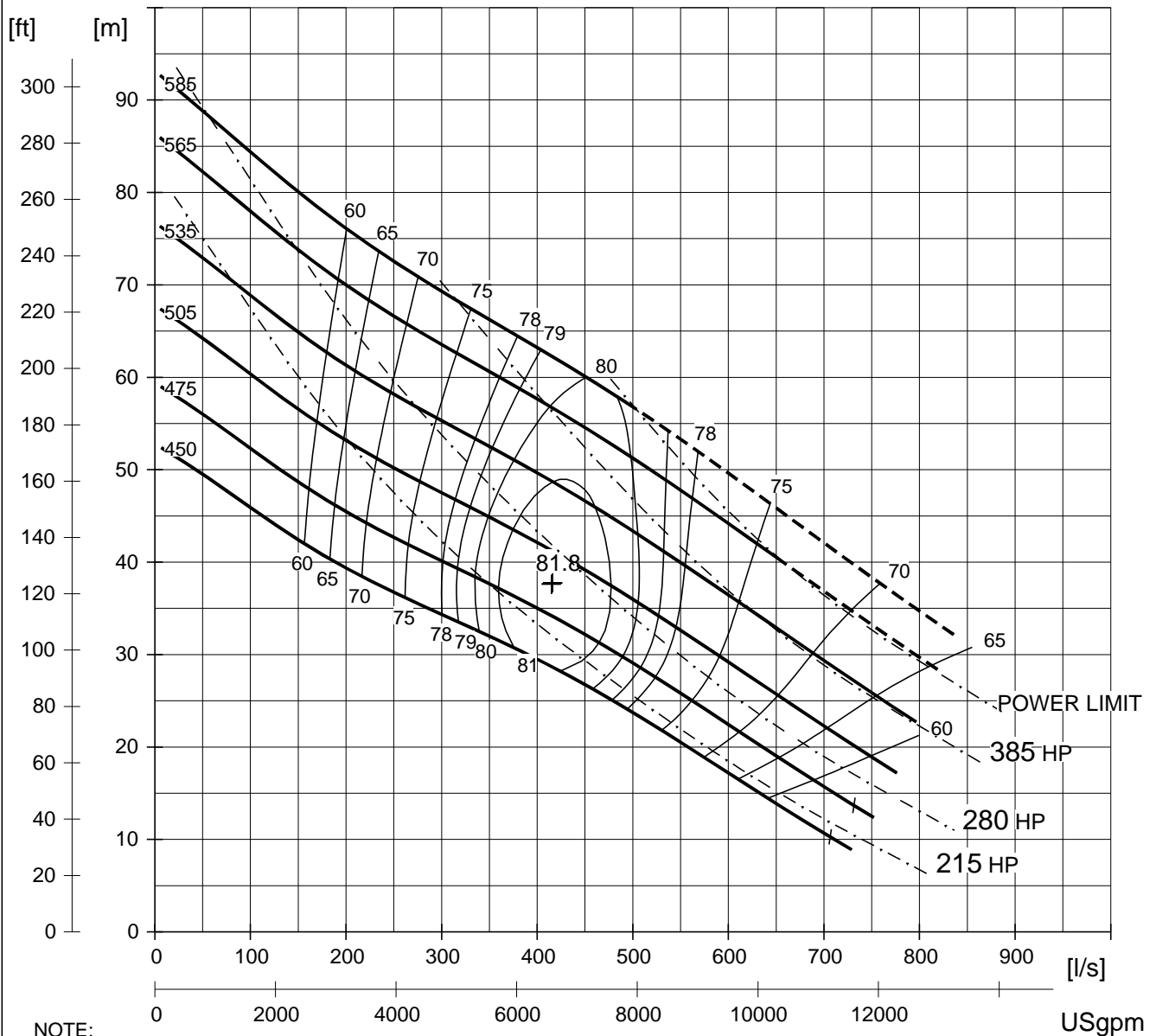

NOTE:  
CURVES ARE BASED ON NOMINAL CONSTANT HYDRAULIC-END SPEED.  
and SHOW PERFORMANCE WITH CLEAR COLD WATER.  
(NPSHR) = (NPSH3) + margins

## FLOW

### (NPSHR)

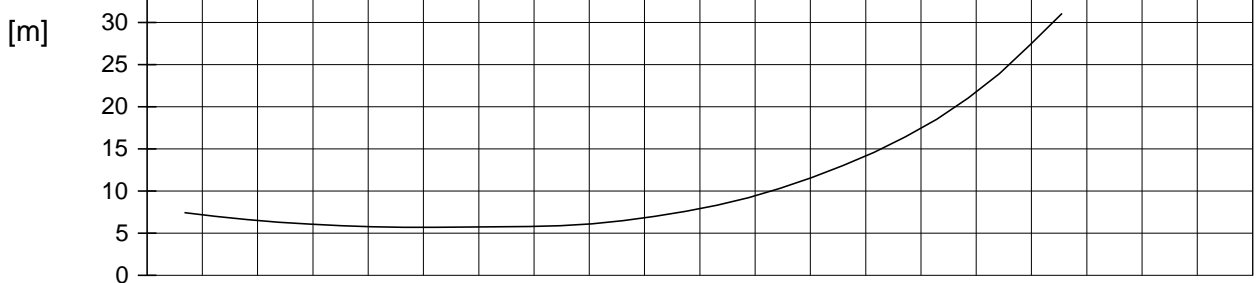

unix AUTHOR: FAS328 CUPF-C (rev:7.34)





# PERFORMANCE FIELD

at Constant nominal speed

PROD.

## N 3312

CURVE NO

### 63-870

DATE <b>2006-03-22</b>	ISSUE <b>2</b>	FREQ. <b>60 HZ</b>	NOMINAL HYDRAULIC-END SPEED <b>895 RPM</b>	
IMPELLER PART	PUMPHOUSING PART	INLET/OUTLET <b>350/300</b>	NO. OF BLADES <b>3</b>	AVAILABLE IMPELLER DIAMETERS EVERY 5 mm FROM 450 TO 585
DRIVE UNIT <b>705</b>	MOTOR <b>43-30-8FA</b>	POLES <b>8</b>	RATED POWER <b>90 HP /67 kW</b>	RATED SPEED RPM
<b>705</b>	<b>43-30-8AA</b>	<b>8</b>	<b>135 HP /101 kW</b>	
<b>735</b>	<b>43-44-8AA</b>	<b>8</b>	<b>185 HP /138 kW</b>	
<b>765</b>	<b>43-56-8AA</b>	<b>8</b>	<b>230 HP /172 kW</b>	

## HEAD

ISO-CURVES :  
( ——— ) PUMP EFFICIENCY [%] and ( - . - . - ) POWER LIMITS

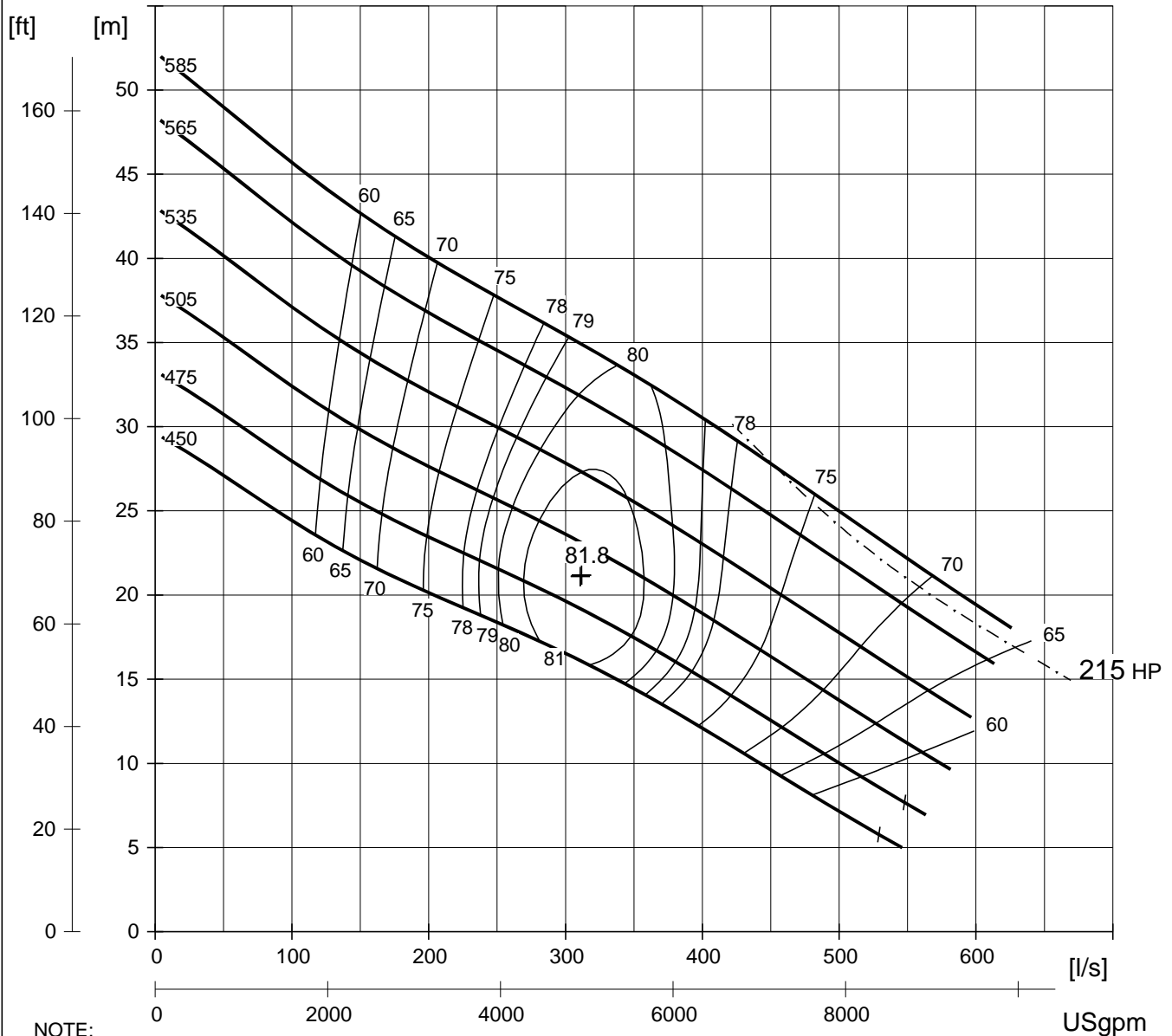

NOTE:

CURVES ARE BASED ON NOMINAL CONSTANT HYDRAULIC-END SPEED.  
and SHOW PERFORMANCE WITH CLEAR COLD WATER.

$$(NPSHR) = (NPSH3) + \text{margins}$$

(NPSHR)

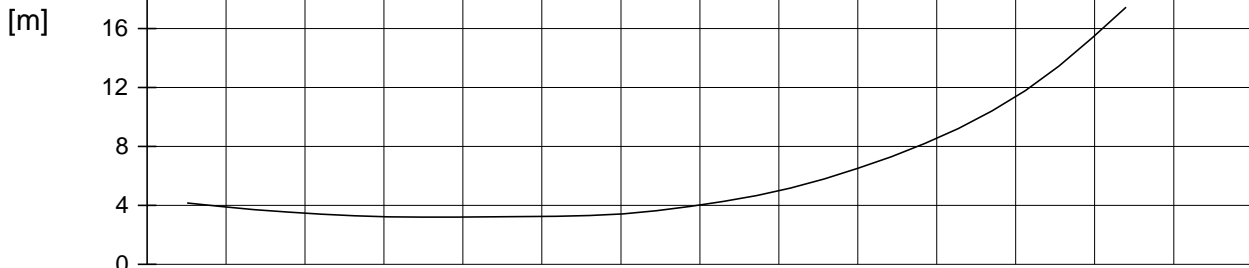

unix AUTHOR: FAS328 CUPF-C(rev:7.34)



# PERFORMANCE FIELD

at Constant nominal speed

PROD.  
**N 3356**

CURVE NO  
**63- 670**

DATE <b>2006-03-22</b>	ISSUE <b>2</b>	FREQ. <b>60 HZ</b>	NOMINAL HYDRAULIC-END SPEED <b>1190 RPM</b>		
IMPELLER PART	PUMPHOUSING PART <b>692 35 00</b>	INLET/OUTLET <b>400/350</b>		NO. OF BLADES <b>3</b>	AVAILABLE IMPELLER DIAMETERS EVERY 5 mm FROM 370 TO 490
DRIVE UNIT <b>665</b>	MOTOR <b>35-45-6AA</b>	POLES <b>6</b>	RATED POWER <b>140 HP /104 kW</b>		RATED SPEED RPM
<b>705</b>	<b>43-30-6BC</b>	<b>6</b>	<b>150 HP /112 kW</b>		
<b>735</b>	<b>43-44-6BC</b>	<b>6</b>	<b>215 HP /160 kW</b>		
<b>765</b>	<b>43-56-6BC</b>	<b>6</b>	<b>280 HP /209 kW</b>		

## HEAD

ISO-CURVES :  
( ——— ) PUMP EFFICIENCY [%] and ( - . - . - ) POWER LIMITS

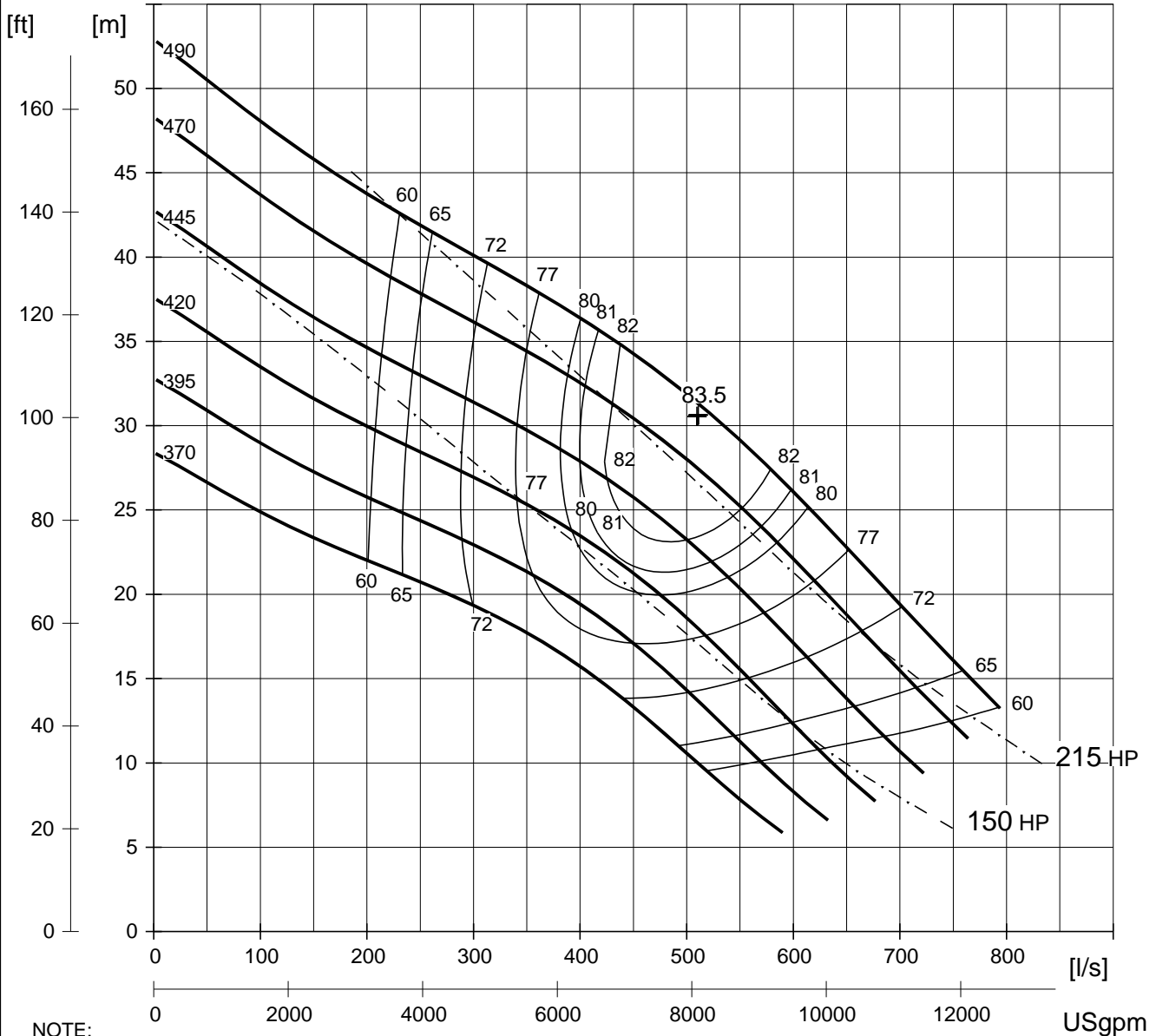

NOTE:  
CURVES ARE BASED ON NOMINAL CONSTANT HYDRAULIC-END SPEED.  
and SHOW PERFORMANCE WITH CLEAR COLD WATER.  
(NPSHR) = (NPSH3) + margins

(NPSHR)

[m]

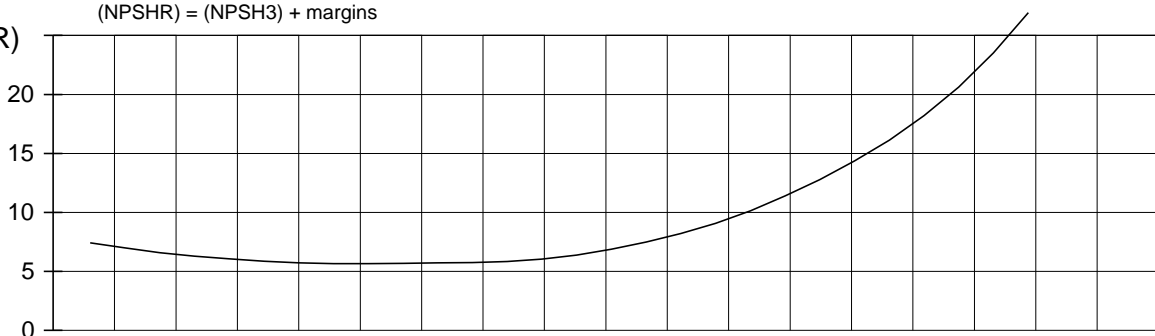

unix AUTHOR: FAS328 CUPF-C (rev:7.34)



# PERFORMANCE FIELD

at Constant nominal speed

PROD.  
**N 3356**

DATE <b>2006-03-22</b>	ISSUE <b>2</b>	FREQ. <b>60 HZ</b>	NOMINAL HYDRAULIC-END SPEED <b>895 RPM</b>	CURVE NO <b>63- 870</b>
IMPELLER PART	PUMPHOUSING PART <b>692 35 00</b>	INLET/OUTLET <b>400/350</b>	NO. OF BLADES <b>3</b>	AVAILABLE IMPELLER DIAMETERS EVERY 5 mm FROM 370 TO 490
DRIVE UNIT <b>605</b>	MOTOR <b>35-29-8AA</b>	POLES <b>8</b>	RATED POWER <b>70 HP /52 kW</b>	RATED SPEED RPM
<b>665</b>	<b>35-35-8AA</b>	<b>8</b>	<b>85 HP /63 kW</b>	
<b>665</b>	<b>35-45-8AA</b>	<b>8</b>	<b>100 HP /75 kW</b>	
<b>705</b>	<b>43-30-8AA</b>	<b>8</b>	<b>135 HP /101 kW</b>	

## HEAD

ISO-CURVES :  
( ——— ) PUMP EFFICIENCY [%] and ( - . - . - ) POWER LIMITS

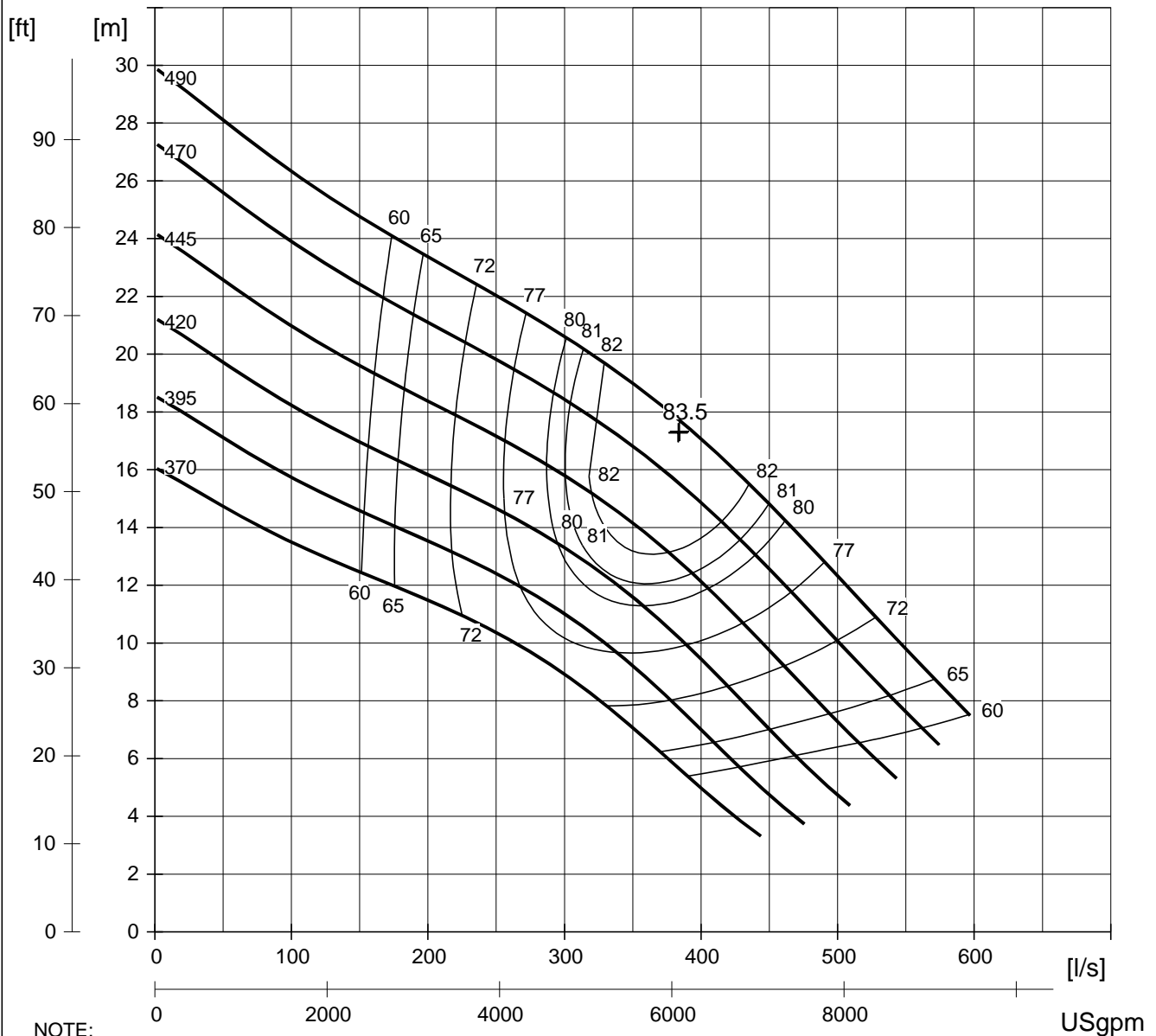

NOTE:  
CURVES ARE BASED ON NOMINAL CONSTANT HYDRAULIC-END SPEED.  
and SHOW PERFORMANCE WITH CLEAR COLD WATER.  
(NPSHR) = (NPSH3) + margins

### (NPSHR)

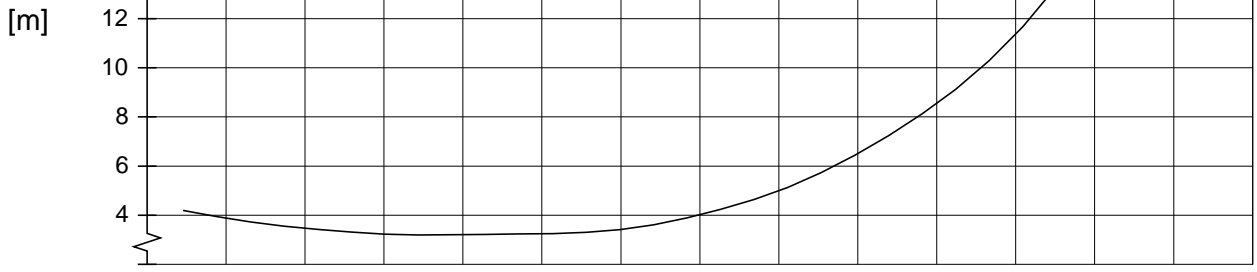

unix AUTHOR: FAS328 CUPF-C (rev:7.34)



# PERFORMANCE FIELD

at Constant nominal speed

PROD.  
**N 3400**

CURVE NO  
**63- 670**

DATE <b>2006-03-22</b>	ISSUE <b>2</b>	FREQ. <b>60 HZ</b>	NOMINAL HYDRAULIC-END SPEED <b>1190 RPM</b>		
IMPELLER PART	PUMPHOUSING PART	INLET/OUTLET <b>500/400</b>		NO. OF BLADES <b>3</b>	AVAILABLE IMPELLER DIAMETERS EVERY 5 mm FROM 470 TO 550
DRIVE UNIT <b>835</b>	MOTOR <b>54-52-6AA</b>	POLES <b>6</b>	RATED POWER <b>385 HP /287 kW</b>		RATED SPEED RPM
<b>865</b>	<b>54-66-6AA</b>	<b>6</b>	<b>470 HP /350 kW</b>		

## HEAD

ISO-CURVES :  
( ——— ) PUMP EFFICIENCY [%] and ( - . . - ) POWER LIMITS

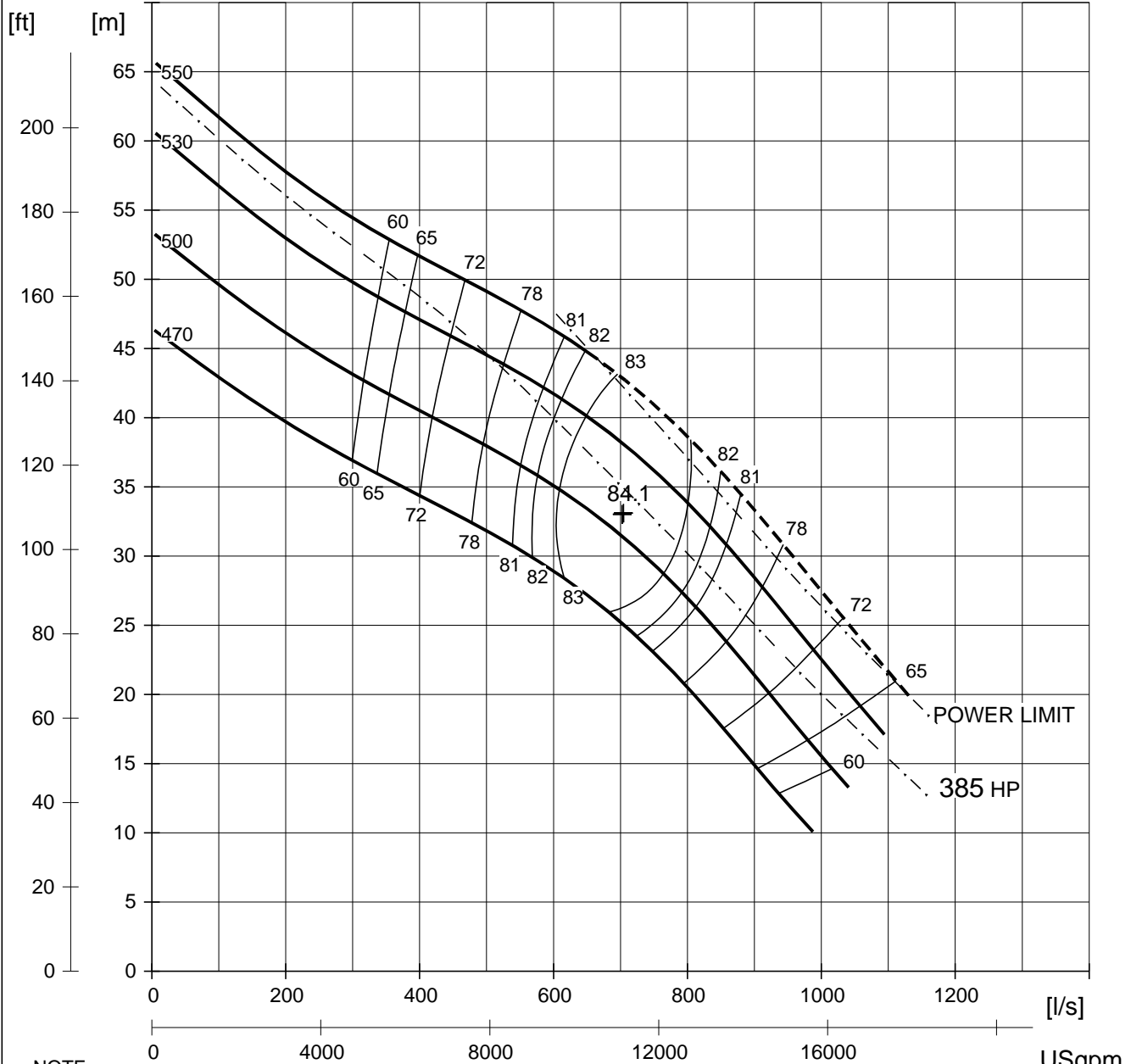

NOTE:  
CURVES ARE BASED ON NOMINAL CONSTANT HYDRAULIC-END SPEED.  
and SHOW PERFORMANCE WITH CLEAR COLD WATER.

$$(NPSHR) = (NPSH3) + margins$$

### (NPSHR)

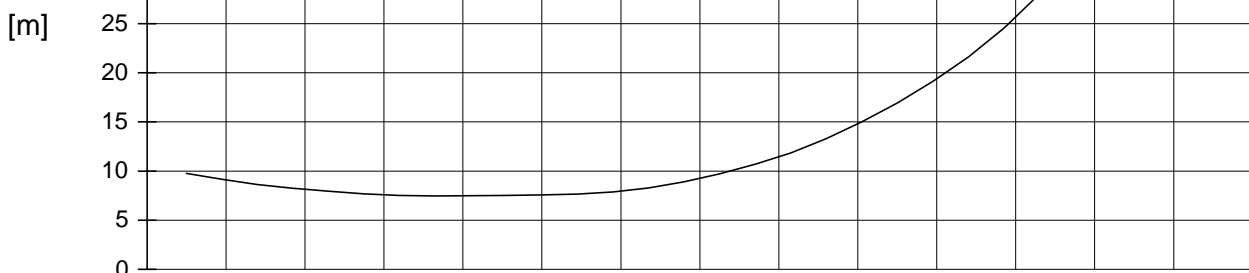

unix AUTHOR: FAS328 CUPF-C (rev:7.34)



# PERFORMANCE FIELD

at Constant nominal speed

PROD.  
**N 3400**

DATE <b>2006-03-22</b>	ISSUE <b>2</b>	FREQ. <b>60 HZ</b>	NOMINAL HYDRAULIC-END SPEED <b>895 RPM</b>	CURVE NO <b>63- 870</b>
IMPELLER PART	PUMPHOUSING PART	INLET/OUTLET <b>500/400</b>	NO. OF BLADES <b>3</b>	AVAILABLE IMPELLER DIAMETERS EVERY 5 mm FROM 470 TO 585
DRIVE UNIT <b>705</b>	MOTOR <b>43-30-8AA</b>	POLES <b>8</b>	RATED POWER <b>135 HP /101 kW</b>	RATED SPEED RPM
<b>735</b>	<b>43-44-8AA</b>	<b>8</b>	<b>185 HP /138 kW</b>	
<b>765</b>	<b>43-56-8AA</b>	<b>8</b>	<b>230 HP /172 kW</b>	
<b>805</b>	<b>54-38-8AA</b>	<b>8</b>	<b>240 HP /179 kW</b>	
<b>835</b>	<b>54-52-8AA</b>	<b>8</b>	<b>335 HP /250 kW</b>	

## HEAD

ISO-CURVES :  
( ——— ) PUMP EFFICIENCY [%] and ( - . - . - ) POWER LIMITS

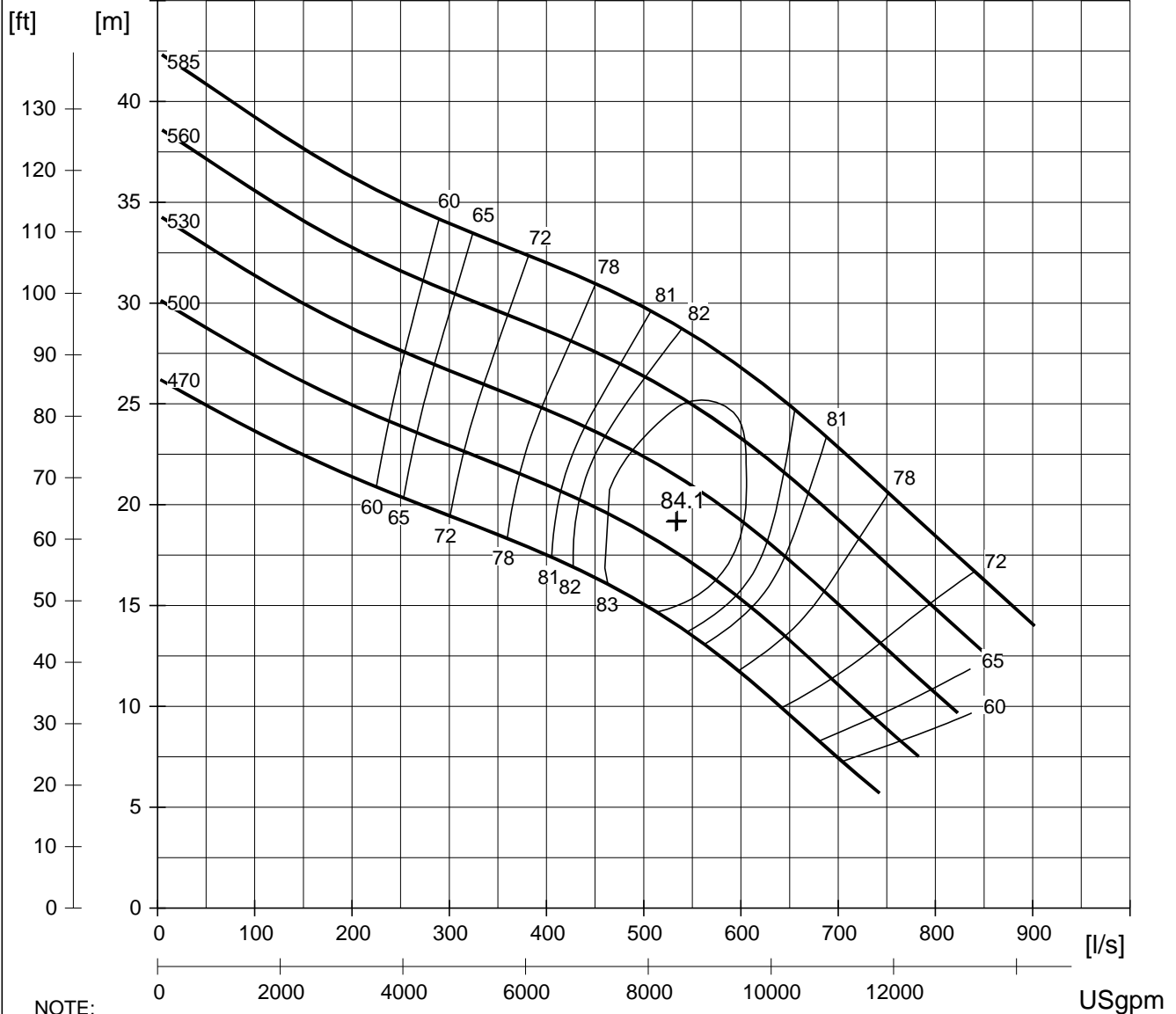

NOTE:  
CURVES ARE BASED ON NOMINAL CONSTANT HYDRAULIC-END SPEED.  
and SHOW PERFORMANCE WITH CLEAR COLD WATER.  
(NPSHR) = (NPSH3) + margins

## FLOW

### (NPSHR)

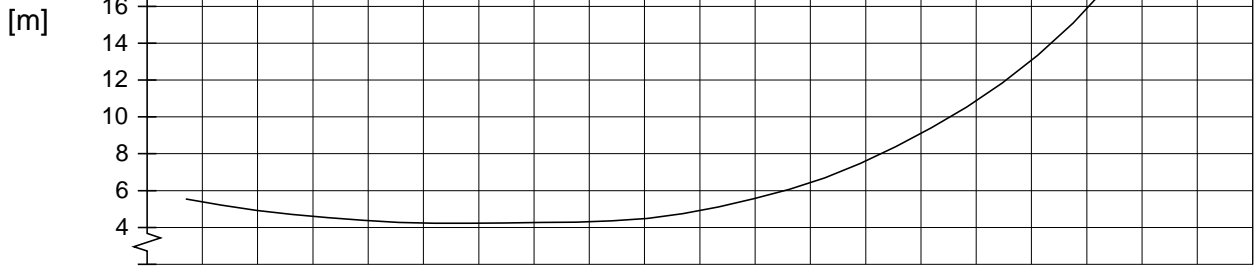

unix AUTHOR: FAS328 CUPF-C(rev:7.34)



# PERFORMANCE FIELD

at Constant nominal speed

PROD.  
**N 3400**

DATE <b>2006-03-22</b>	ISSUE <b>2</b>	FREQ. <b>60 HZ</b>	NOMINAL HYDRAULIC-END SPEED <b>715 RPM</b>	CURVE NO <b>63- 1070</b>
IMPELLER PART	PUMPHOUSING PART	INLET/OUTLET <b>500/400</b>	NO. OF BLADES <b>3</b>	AVAILABLE IMPELLER DIAMETERS EVERY 5 mm FROM 470 TO 585
DRIVE UNIT <b>705</b>	MOTOR <b>43-30-10GA</b>	POLES <b>10</b>	RATED POWER <b>90 HP /67 kW</b>	RATED SPEED RPM
<b>735</b>	<b>43-44-10FA</b>	<b>10</b>	<b>135 HP /101 kW</b>	

## HEAD

ISO-CURVES :  
( ——— ) PUMP EFFICIENCY [%] and ( - . - . - ) POWER LIMITS

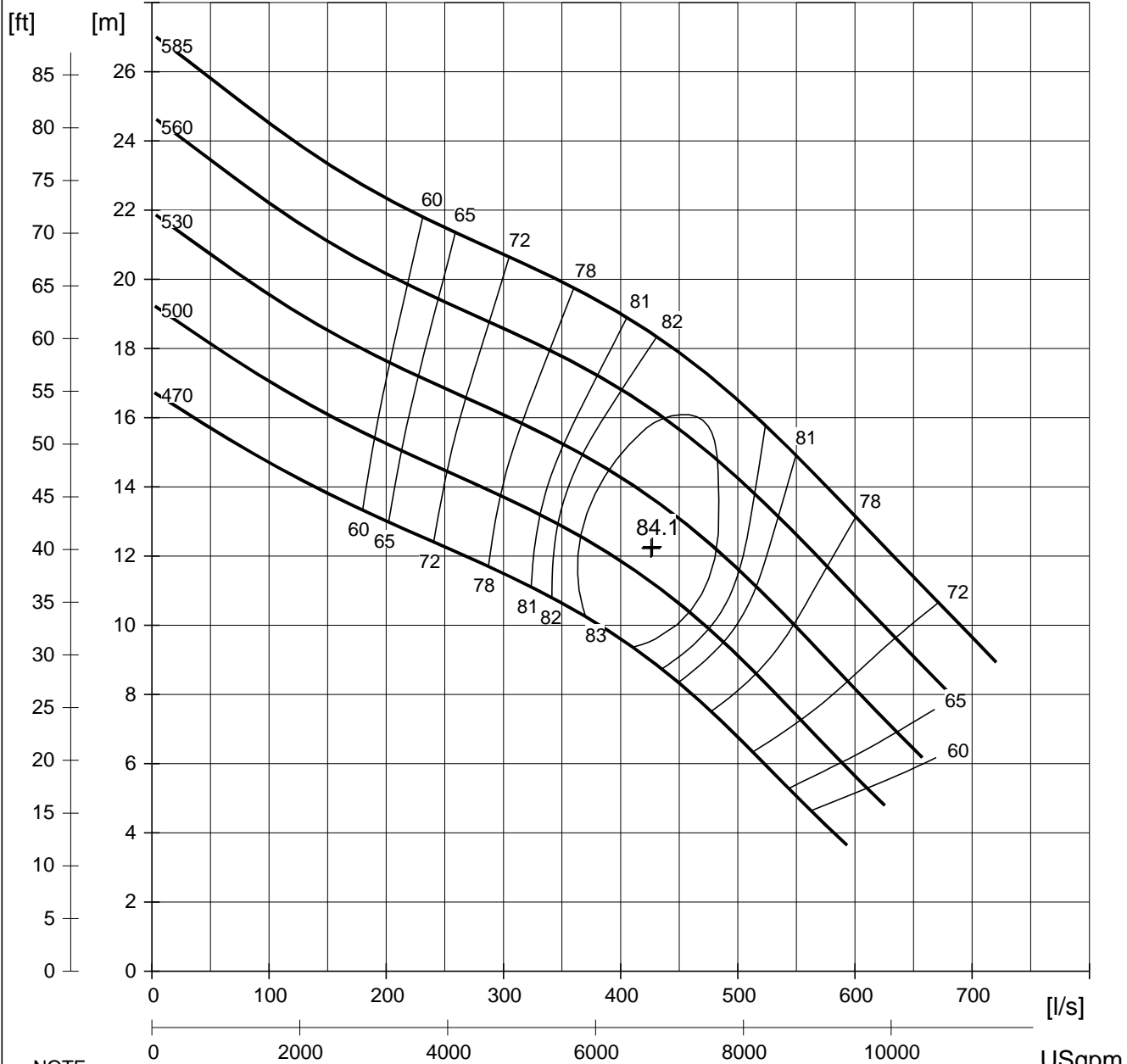

NOTE:  
CURVES ARE BASED ON NOMINAL CONSTANT HYDRAULIC-END SPEED.  
and SHOW PERFORMANCE WITH CLEAR COLD WATER.  
(NPSHR) = (NPSH3) + margins

### (NPSHR)

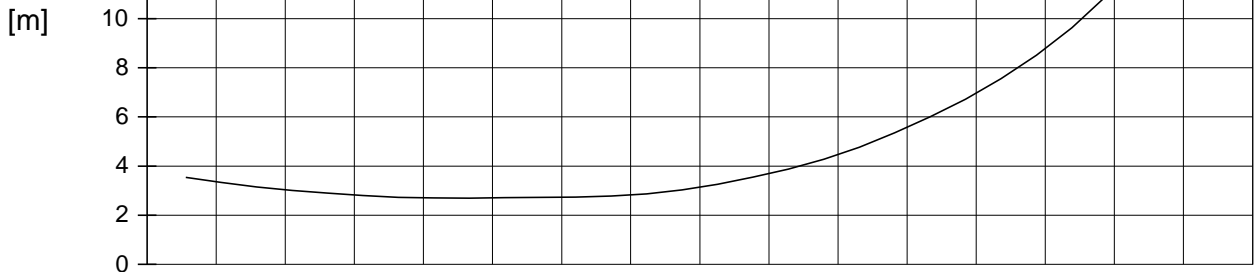

unix AUTHOR: FAS328 CUPF-C(rev:7.34)



# PERFORMANCE FIELD

at Constant nominal speed

PROD.  
**N 3400**

DATE <b>2006-03-22</b>	ISSUE <b>2</b>	FREQ. <b>60 HZ</b>	NOMINAL HYDRAULIC-END SPEED <b>595 RPM</b>	CURVE NO <b>63- 1270</b>
IMPELLER PART	PUMPHOUSING PART	INLET/OUTLET <b>500/400</b>	NO. OF BLADES <b>3</b>	AVAILABLE IMPELLER DIAMETERS EVERY 5 mm FROM 470 TO 585
DRIVE UNIT <b>705</b>	MOTOR <b>43-30-12FA</b>	POLES <b>12</b>	RATED POWER <b>45 HP /34 kW</b>	RATED SPEED RPM
<b>705</b>	<b>43-30-12AA</b>	<b>12</b>	<b>60 HP /45 kW</b>	
<b>735</b>	<b>43-44-12AA</b>	<b>12</b>	<b>90 HP /67 kW</b>	

## HEAD

ISO-CURVES :  
( ——— ) PUMP EFFICIENCY [%] and ( - . - . - ) POWER LIMITS

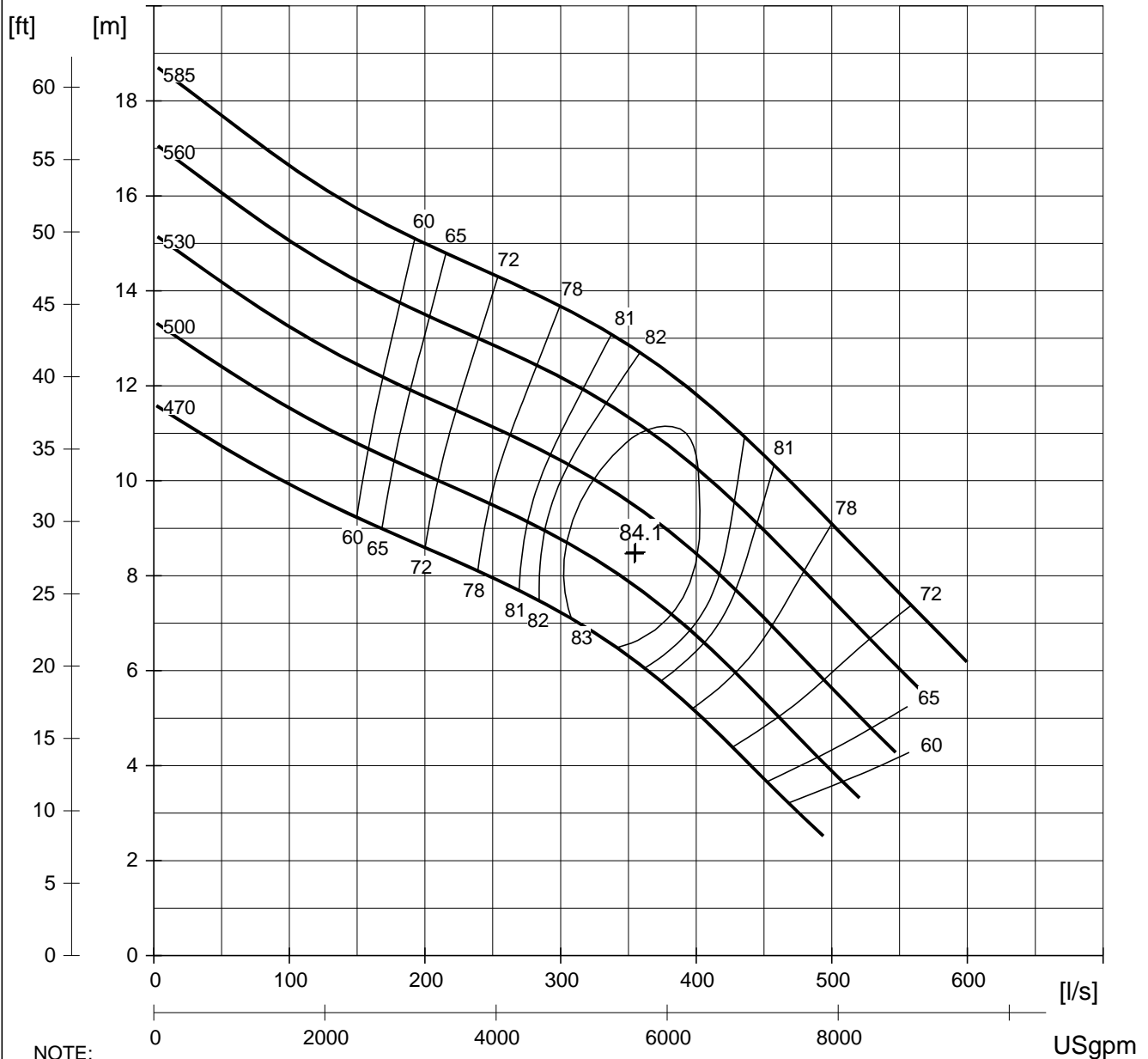

NOTE:  
CURVES ARE BASED ON NOMINAL CONSTANT HYDRAULIC-END SPEED.  
and SHOW PERFORMANCE WITH CLEAR COLD WATER.  
(NPSHR) = (NPSH3) + margins

## FLOW

### (NPSHR)

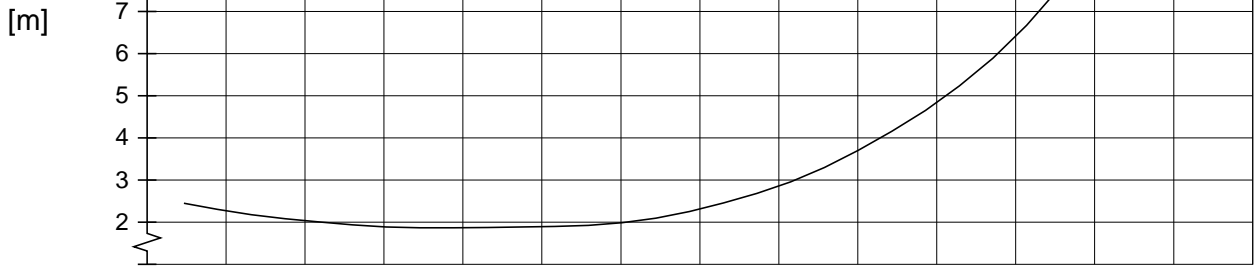

unix AUTHOR: FAS328 CUPF-C (rev:7.34)