



# Flygt Submersible Pumps

AVAILABLE FOR RENTAL AND SALE



[www.motralec.com](http://www.motralec.com) / [service-commercial@motralec.com](mailto:service-commercial@motralec.com) / 01.39.97.65.10

### HS 5520

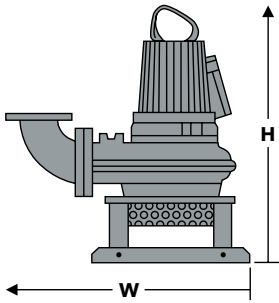

Model number: 5520.180  
 Motor rating: 5 HP @ 1735 RPM  
 Voltage (3 $\phi$ ): 460V  
 Full load amps: 6.6A  
 Discharge conn: 4" Flange  
 Impeller code: 436  
 Pump dimensions: 29 1/2" W (max.),  
 33 1/2" H (max.)  
 Max. weight (lbs.): 380  
 Stator and pump housing material: Cast iron  
 Options: FM approved variant;  
 Warm liquid version available

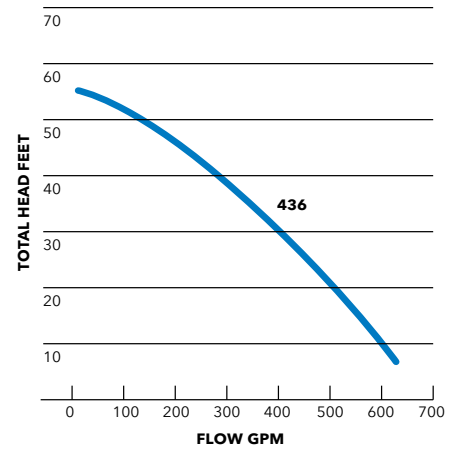

### HS 5530

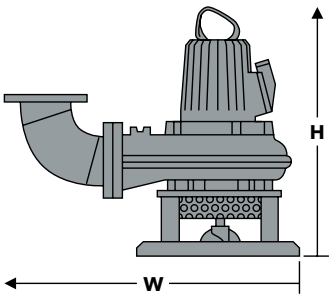

Model number: 5530.180  
 Motor rating: 10 HP @ 1740 RPM  
 Voltage (3 $\phi$ ): 460V  
 Full load amps: 13A  
 Discharge conn: 6" Flange  
 Impeller code: 436  
 Pump dimensions: 42 1/2" W (max.),  
 40" H (max.)  
 Max. weight (lbs.): 680  
 Stator and pump housing material: Cast iron  
 Options: Agitator;  
 FM approved variant;  
 Warm liquid version available

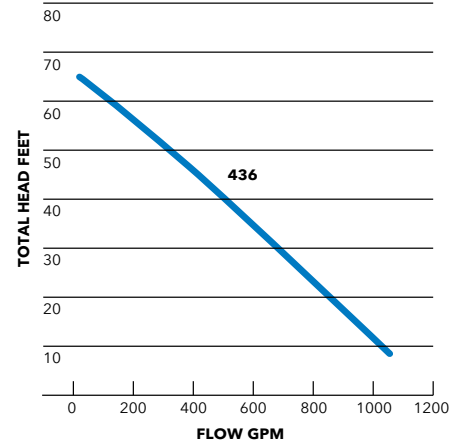

### HS 5540

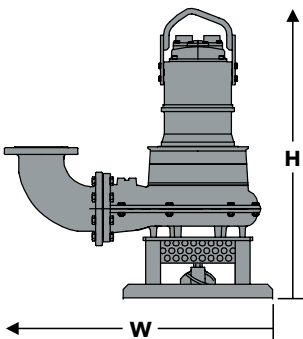

Model number: 5540.181  
 Motor rating: 20 HP @ 1750 RPM  
 Voltage (3 $\phi$ ): 460V  
 Full load amps: 26  
 Discharge conn: 6" Flange  
 Impeller code: 434  
 Pump dimensions: 42 1/2" W (max.),  
 46 1/4" H (max.)  
 Max. weight (lbs.): 891  
 Stator and pump housing material: Cast iron  
 Options: Agitator (Imp. Code 435);  
 FM approved variant;  
 Warm liquid version available

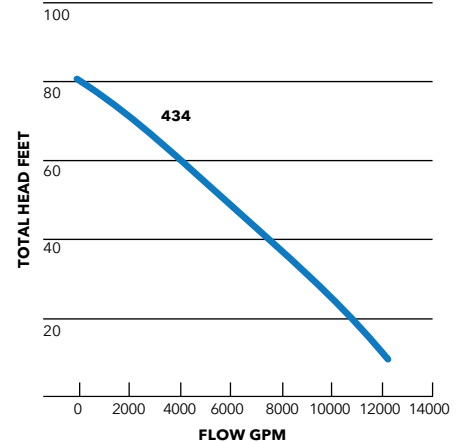

### HS 5570

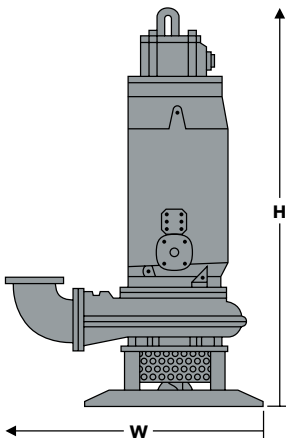

Model number: 5570.180  
 Motor rating: 335 HP @ 1760 RPM  
 280 HP @ 1185 RPM  
 Voltage (3 $\phi$ ): 460V 575V  
 Full load amps: 365/345A 300/266A  
 Discharge conn: 8" Flange  
 Impeller code: 470, 670  
 Pump dimensions: 59" W (max.),  
 80 1/4" H (max.)  
 Max. weight (lbs.): 3230  
 Stator and pump housing material: Cast iron  
 Options: Agitator;  
 FM approved variant;  
 Warm liquid version available

