



Flygt Submersible Pumps

AVAILABLE FOR RENTAL AND SALE



www.motralec.com / service-commercial@motralec.com / 01.39.97.65.10

HS 5520

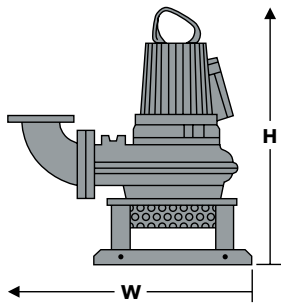

Model number: 5520.180
 Motor rating: 5 HP @ 1735 RPM
 Voltage (3 ϕ): 460V
 Full load amps: 6.6A
 Discharge conn: 4" Flange
 Impeller code: 436
 Pump dimensions: 29 1/2" W (max.),
 33 1/2" H (max.)
 Max. weight (lbs.): 380
 Stator and pump housing material: Cast iron
 Options: FM approved variant;
 Warm liquid version available

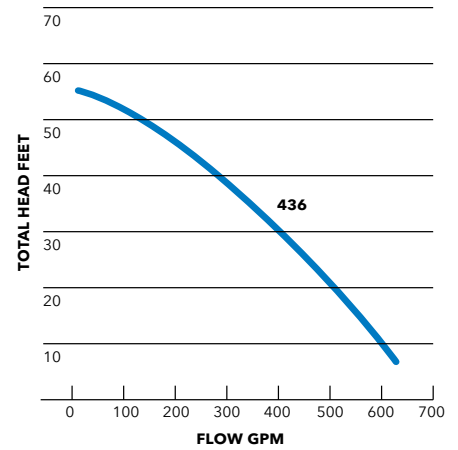

HS 5530

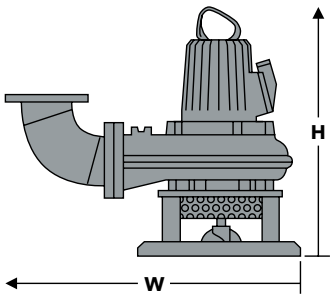

Model number: 5530.180
 Motor rating: 10 HP @ 1740 RPM
 Voltage (3 ϕ): 460V
 Full load amps: 13A
 Discharge conn: 6" Flange
 Impeller code: 436
 Pump dimensions: 42 1/2" W (max.),
 40" H (max.)
 Max. weight (lbs.): 680
 Stator and pump housing material: Cast iron
 Options: Agitator;
 FM approved variant;
 Warm liquid version available

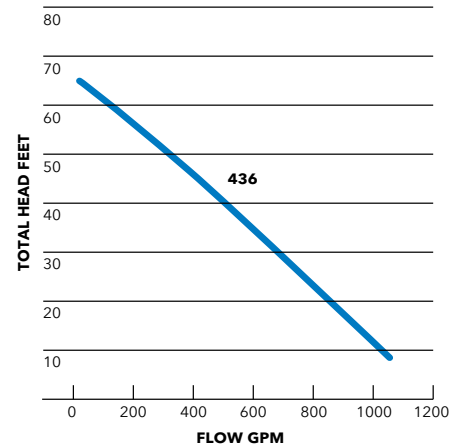

HS 5540

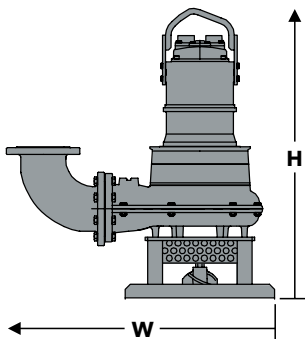

Model number: 5540.181
 Motor rating: 20 HP @ 1750 RPM
 Voltage (3 ϕ): 460V
 Full load amps: 26
 Discharge conn: 6" Flange
 Impeller code: 434
 Pump dimensions: 42 1/2" W (max.),
 46 1/4" H (max.)
 Max. weight (lbs.): 891
 Stator and pump housing material: Cast iron
 Options: Agitator (Imp. Code 435);
 FM approved variant;
 Warm liquid version available

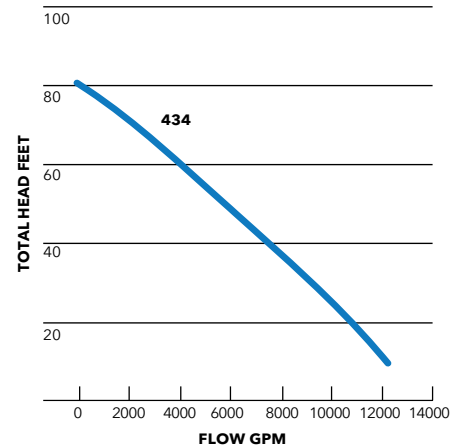

HS 5570

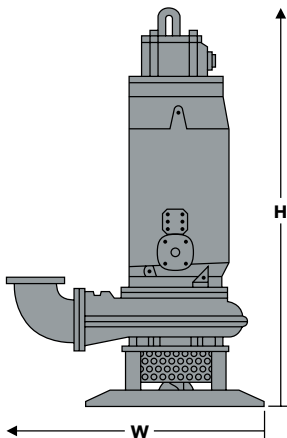

Model number: 5570.180
 Motor rating: 335 HP @ 1760 RPM
 280 HP @ 1185 RPM
 Voltage (3 ϕ): 460V 575V
 Full load amps: 365/345A 300/266A
 Discharge conn: 8" Flange
 Impeller code: 470, 670
 Pump dimensions: 59" W (max.),
 80 1/4" H (max.)
 Max. weight (lbs.): 3230
 Stator and pump housing material: Cast iron
 Options: Agitator;
 FM approved variant;
 Warm liquid version available

