



Flygt C-pumps 3068-3800

SUBMERSIBLE WASTE AND RAW WATER PUMPS

Flygt submersible pumps for a variety of applications

Submersibles Flygt pumps operate directly in the liquid being pumped, which means they require neither special housing nor a superstructure to support them, considerably reducing construction costs. They are smaller than non-submersible counterparts as the motor and hydraulics are integrated into one compact unit, resulting in smaller pumping stations that are less complex to build. Operating submerged they take up less space, and noise and cooling problems are virtually eliminated.

An extensive range of hydraulic units, such as impeller and volute, are available to handle different types of media. The application ranges up to approx. 3000 l/s. A variety of drive units, with motor ratings up to 680 kW 50 Hz, 1040 hp/775 kW 60 Hz are also available. The standard version of these pumps are made in cast iron and for more demanding applications the pumps can be supplied in industrial configurations. Explosion-proof versions are also available.

This series of pumps has an extensive performance range and can be used in a variety of applications:

- Pumping sewage in municipal applications
- Irrigation
- Industrial effluent
- Cooling water
- Storm water
- Process water
- Raw water



Methods of installation

To reduce the cost of installation Xylem has standardized many of the main elements of pumping stations so that they can be combined to match specific site conditions.

The examples illustrated here show the flexibility of the system, and provide some guidelines for optimizing the design of your own station.

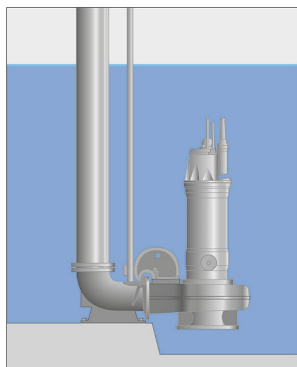

CP - For semi-permanent wet well installations. The pump is installed with twin guide bars on a discharge connection.

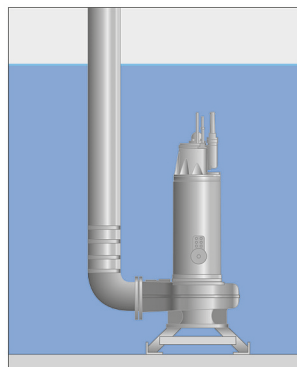

CS - A semi-permanent, free-standing installation. Transportable version with pipe or hose connection.

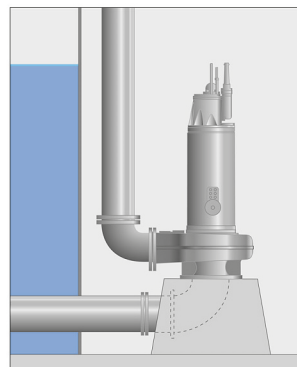

CT - A vertically-mounted, permanent dry well or in-line installation with flange connections for suction and discharge pipe work.

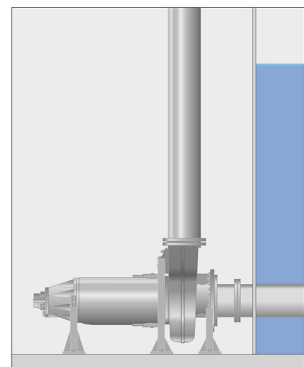

CZ - A horizontally-mounted, permanent dry well or in-line installation with flange connections for suction and discharge pipe work.

General performance range up to 3000 l/s

Flygt C-pumps

C3000 50Hz

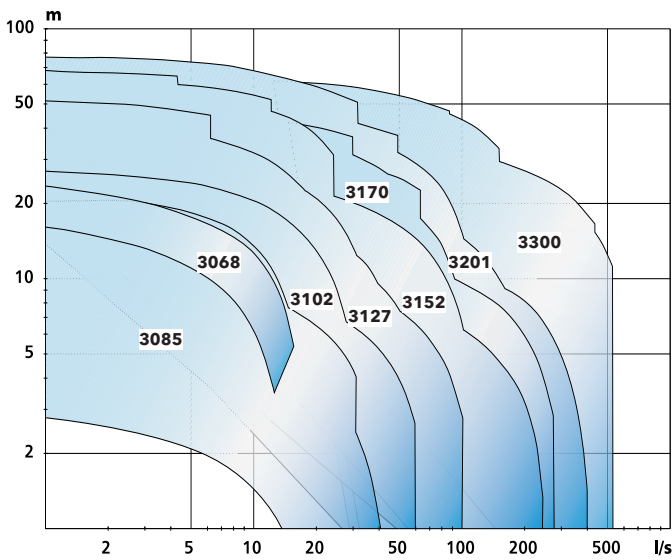

C3001 50Hz

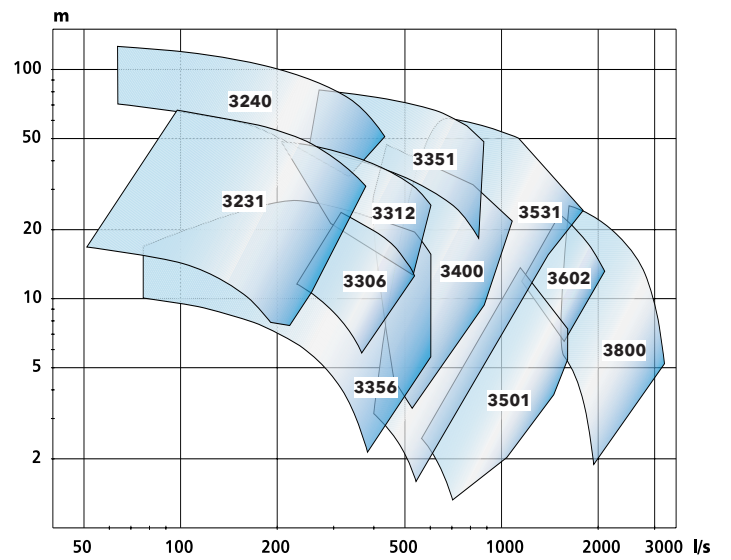

C3000 60Hz

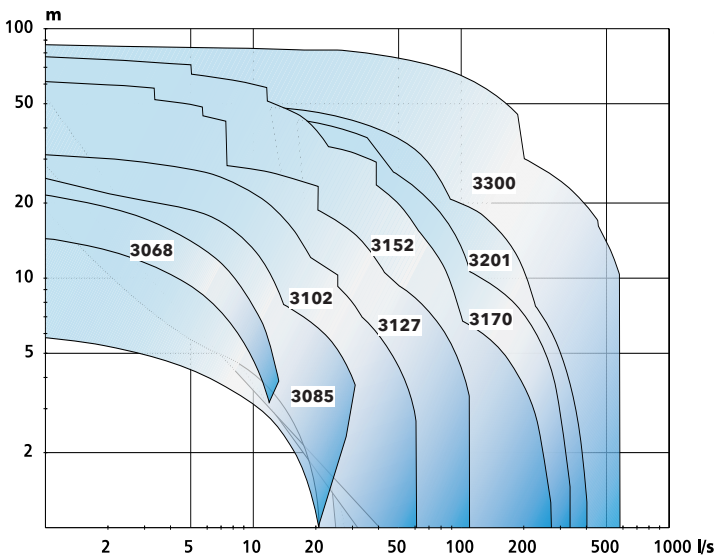

C3001 60Hz

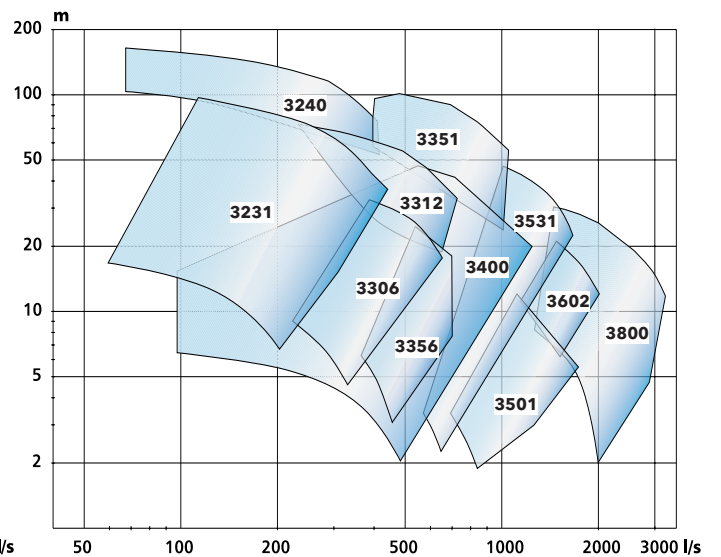

Product quality in every detail

Motor

Squirrel cage, high performance induction motor, specially designed and manufactured by Xylem for submersible use. Stator windings are trickle impregnated in resin to class H insulation and rated at 180° C (355° F). Many units provide up to 30 starts per hour.

Shaft

A short overhang of the shaft virtually eliminates shaft deflection. This results in significantly increased seal and bearing life, low vibration and quiet operation.

Seals

Two sets of mechanical shaft seals that work independently for double security. Designed, patented and manufactured by Xylem.

Oil housing

In addition to lubricating the seals, the food-grade oil filled compartment diffuses heat from the motor and the bearings. The housing also provides additional security against penetration by liquids.

Impeller

The Flygt Nevaclog® impeller is designed specially for smaller Flygt C-pumps. Our Flygt Nevaclog® has excellent flow passing properties, because parts that might cause clogging in the impeller channel have been eliminated. This, coupled with the volute's design is what enables wastewater to flow freely.

Seal wear protection

Spin-out™ is a patented design that protects the outer seal by expelling abrasive particles from the seal chamber. As an integral part of the cast-iron housing, Spin-out™ is as simple as it is effective.

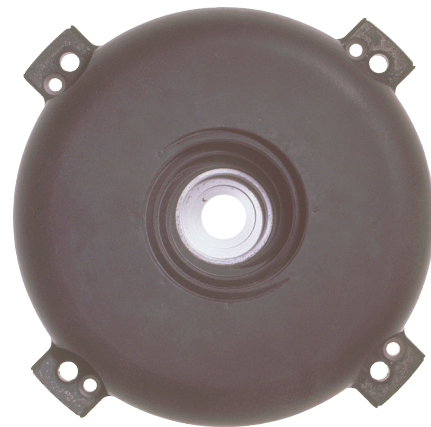
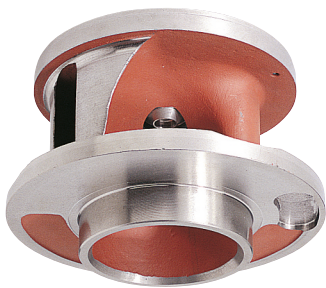
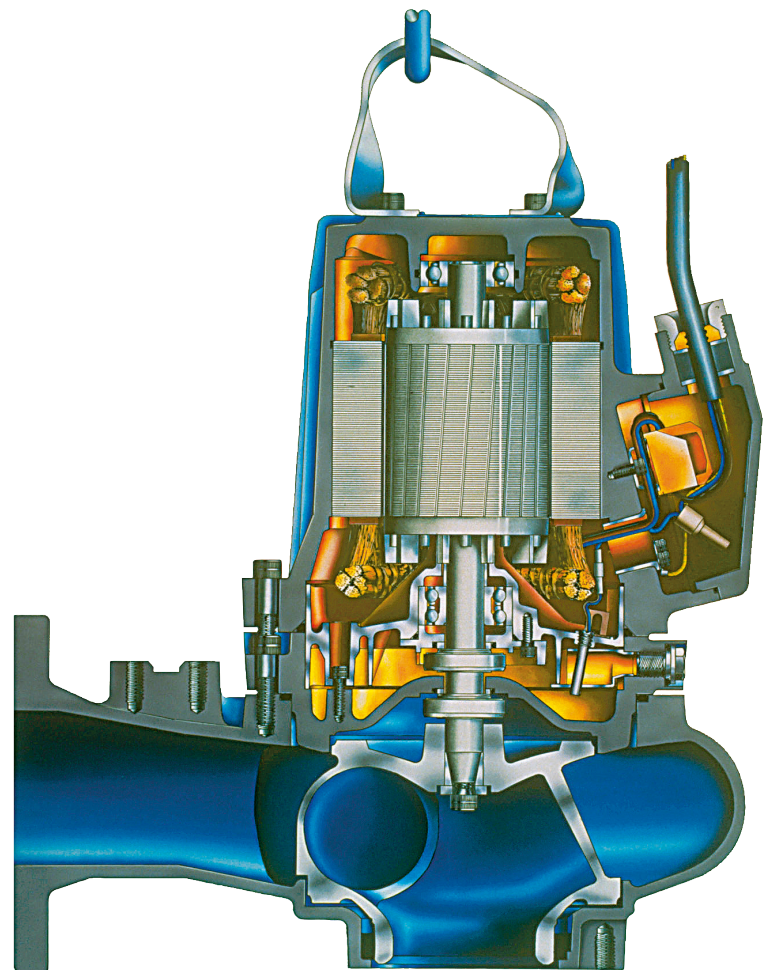

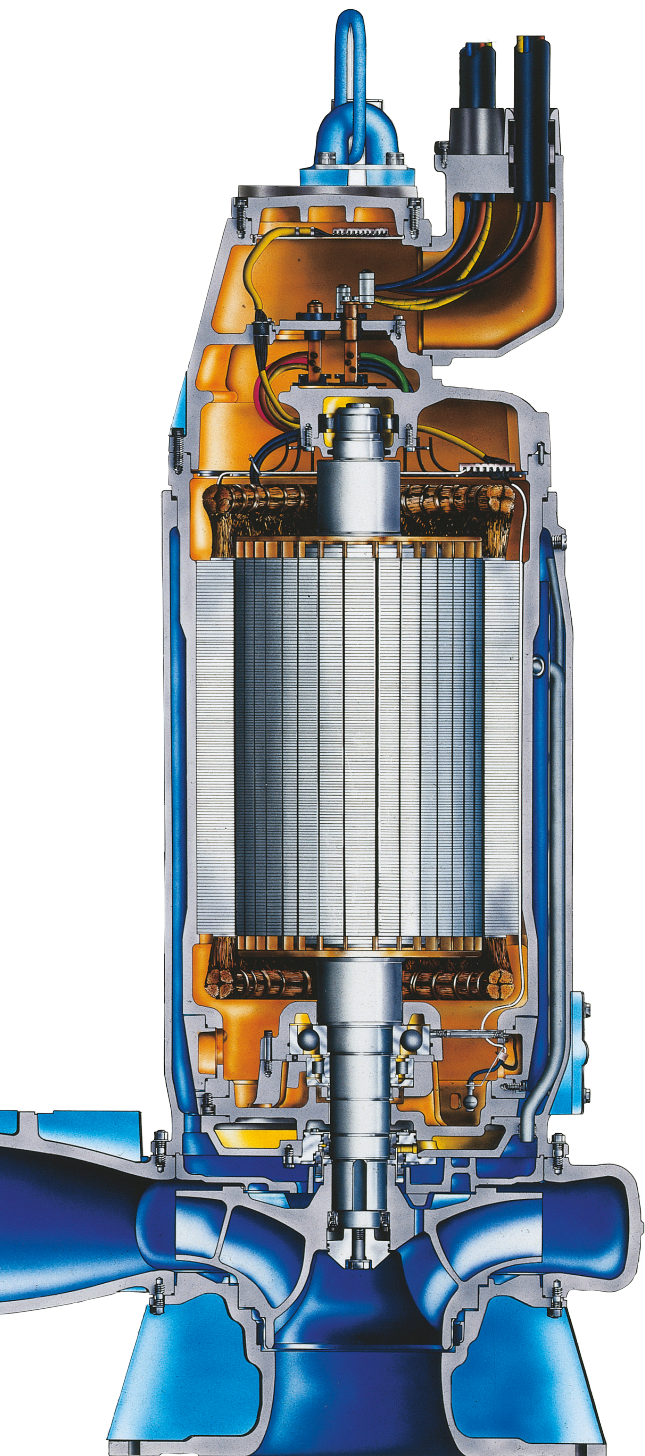

Monitoring

Thermal sensors embedded in the stator windings help prevent overheating. Leakage sensors in the stator and oil housings, together with external monitoring equipment, are available as options.

Cable entry

The cable entrance is designed to incorporate both a seal and a strain relief function.

International standards approvals

All pumps are tested and approved in accordance with national and international standards (IEC 34-1 CSA). They are also available in explosion-proof versions - Factory Mutual and European Norm (FM and EN) approvals.

Cooling System

In normal applications the surrounding liquid cools the pump motor. In more demanding applications, or when dry installed, the pumps can be fitted with an integrated cooling system.

Impeller

The multi-vane impellers for bigger pumps are designed for optimum hydraulic efficiency. The impellers are dynamically balanced and machined to match the requested duty point. The area in the pump housing at the upper and lower shroud of the impeller has a labyrinth seal design to prevent leakage and clogging, thus improve the efficiency. Replaceable wear rings are standard.



Accessories for trouble-free, efficient pumping

Supplying customers with problem-free solutions is our goal at Xylem - and that means more than simply supplying the correct pump for your particular application.

The following are examples of some of the ancillary equipment and systems which we can supply as aids to improving the all-round efficiency of your operation.

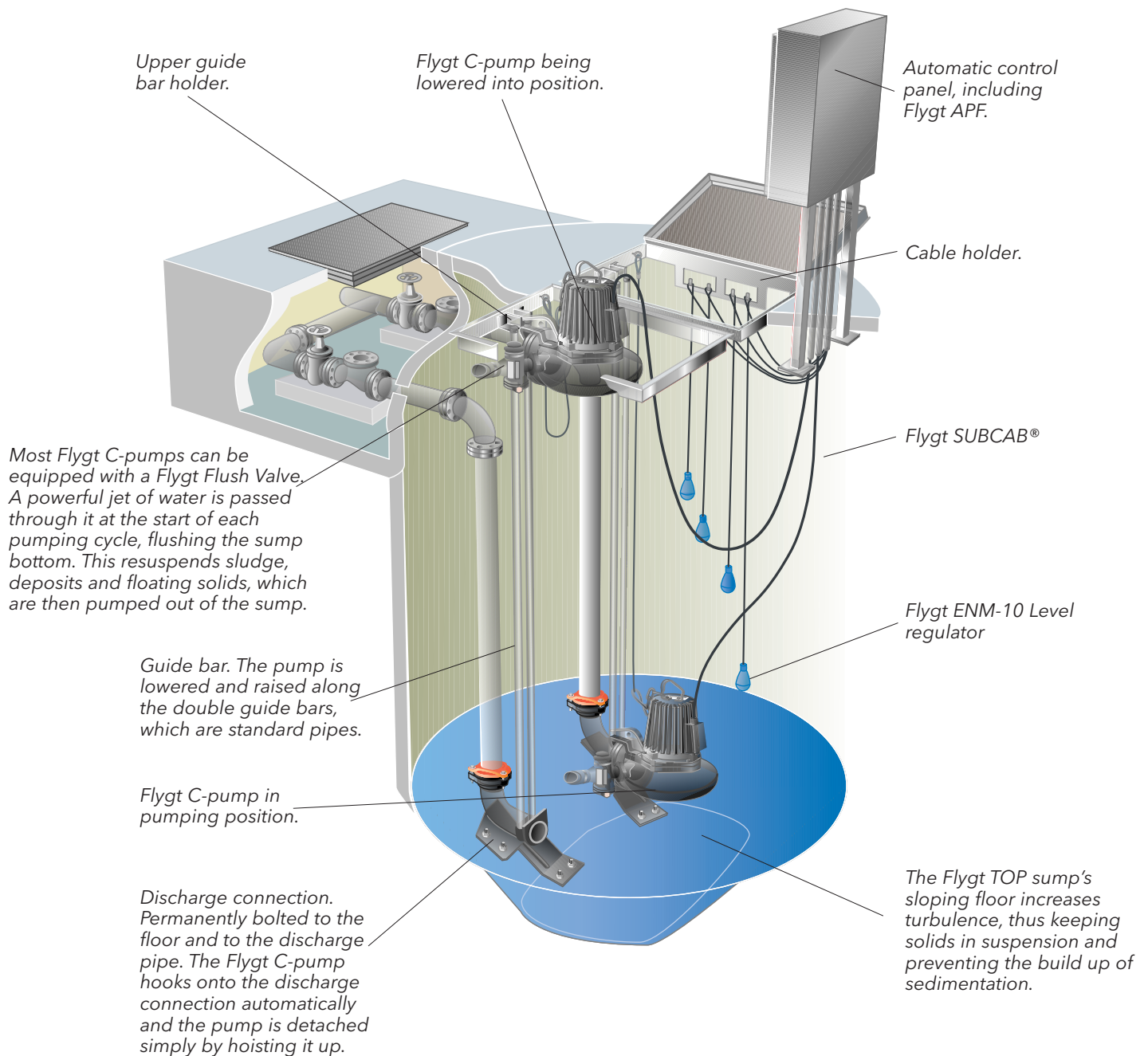

Monitoring and control equipment

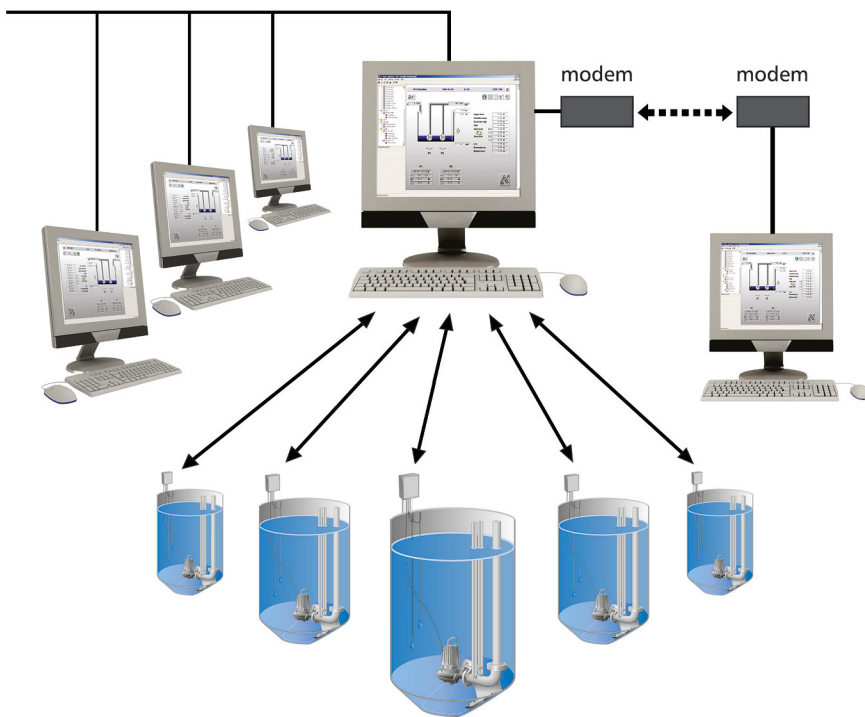

Intelligent systems for pumps and mixers

At Xylem we produce monitoring and control systems for a wide range of pumps and mixers. Our systems offer lower maintenance costs, reliability, long life and reduced energy consumption.

As well as supplying the hardware, such as pump controllers, sensors, electrical start equipment and cables, we also have software for running the system. The Flygt AquaView supervision software provides the PC-based SCADA know-how.

Our systems can be used to run and monitor applications working in sewage treatment plants, sewage and drainage pumping and mixing.

World-wide service, world-class value

No two pumping stations and systems will be alike, so the level of maintenance and support that you require from your service partner will differ according to your situation. With Xylem, you can choose the type of support package that precisely meets your needs.

From simply supplying pumps to your specifications, to full service assistance on system planning, design, construction, implementation, operation or maintenance: Xylem's total service concept means that you get the service you need, on your terms.

15-year spare parts guarantee

We guarantee availability of spare parts for at least 15 years after we stop production of a pump model. This is just one of the ways in which Xylem meets its long-term commitment to customers.

