

ALME / ALPE

ELECTRONIC IN-LINE PUMPS FOR CIRCULATION SYSTEMS



TECHNICAL DATA

Operating range:

from 1 to 8,4 m³/h with head up to 21 metres.

Liquid temperature range: from -15 °C to +120 °C.

Pumped liquid: clean, free of solids and abrasives, non-viscous, non-aggressive, non-crystallised and chemically neutral, with properties similar to water. Maximum glycol content 30% (for other glycol percentages contact Technical Support).

Installation: fixed, horizontal position.

Maximum ambient temperature: +40 °C.

Maximum operating pressure: 10 bar (1000 kPa).

Protection class: IP 55.

Insulation class: F.

Standard voltage: single-phase 220-240 V, 50/60 Hz.

APPLICATIONS

Hot or cold water circulation pump with in-line ports, suitable for installation directly on the pipework of on civil and industrial heating, air conditioning, refrigeration, and sanitary water plants. Particularly versatile thanks to the use of the MCE/C inverter, offering performance features capable of automatically adapting to the different needs of the system, keeping a consistent differential pressure.

CONSTRUCTION FEATURES OF THE PUMP

Pump body and motor support in cast iron.

2" M-GAS suction and delivery ports. Technopolymer impeller. Carbon/ceramic mechanical seal.

Construction features of the motor

External ventilation cooling, closed, asynchronous type, with four poles for the ALM version, and two poles for the ALP version.

Rotor running on permanently lubricated ball bearings, oversized to ensure low noise and durability.

Construction according to CEI 2-3.

CONSTRUCTION FEATURES OF THE ELECTRONICS: MCE/C INVERTER

MCE/C inverters are the latest technological achievement of the DAB inverter range. They represent a new generation of inverters for use with circulation pumps, and set themselves apart due to ease of use, power, simplicity of installation and management. MCE/C inverters have been designed for managing circulation pumps. By allowing a simple adjustment of the differential pressure, they give the possibility of adjusting the performance of the circulation pump to the actual system requirements. They are fitted on the fan cover of the motor. This makes the installation of the pump with MCE/C particularly easy and quick. The protection class of the MCE/C is IP55. The easy of programming is guaranteed by the use of a simple and intuitive interface, similar to Dialogue electronic circulators, and a graphic display. MCE/C inverters have a double micro-processor construction that guarantees maximum efficiency and reliability.

A reliable and sturdy construction, together with a modern and innovative design, complete the product, also in terms of aesthetic value. MCE/C inverters protect the motor and the pump, and increase their life, by eliminating hammering effects and making the pump rotate at the minimum number of rotations capable of meeting the requirements of the user. In addition, electric pumps controlled by the MCE/C inverter are environmentally friendly. In fact, by ensuring that the pump only uses the power that is strictly necessary for meeting the needs of the users, electricity consumption is strongly reduced when compared with fixed speed pumps. It is possible to create twin units by using the appropriate cable for the connection of MCE/C inverters.

ALME / ALPE

ELECTRONIC IN-LINE PUMPS FOR CIRCULATION SYSTEMS

MATERIALS

N.	PARTS	MATERIALS
1	PUMP BODY	CAST IRON 250 UNI ISO 185
3	SUPPORT	CAST IRON 250 UNI ISO 185
4	IMPELLER	TECHNOPOLYMER
7	SHAFT WITH ROTOR	AISI 303 STAINLESS STEEL X10 CrNiS 1809 UNI 6900/71
16	MECHANICAL SEAL	CARBON / CERAMIC
28	OR RING	EPDM RUBBER

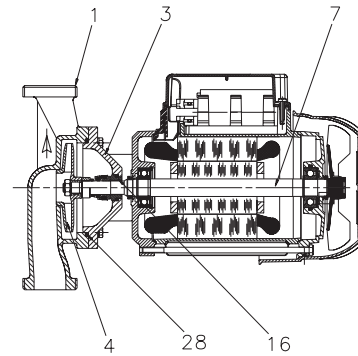

– Legend:
(example)

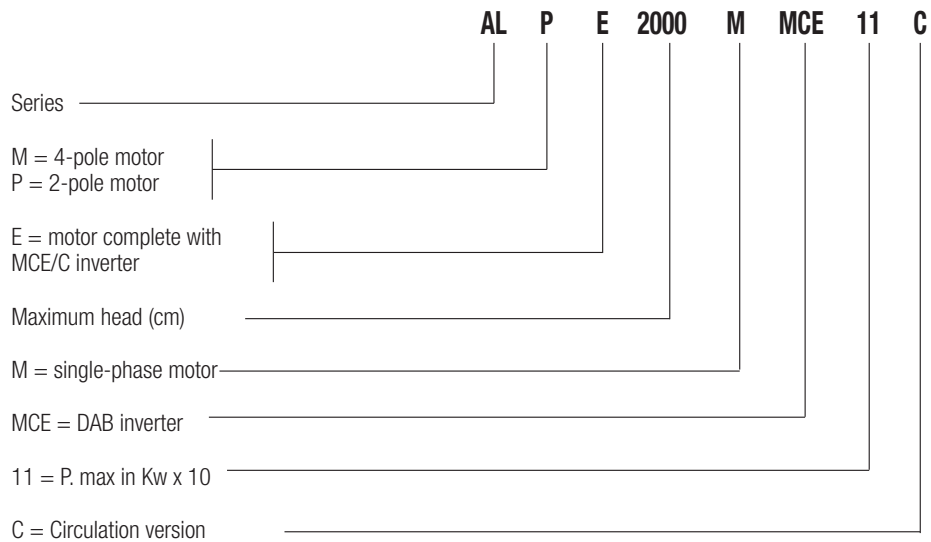

Installation: fixed, horizontal position.

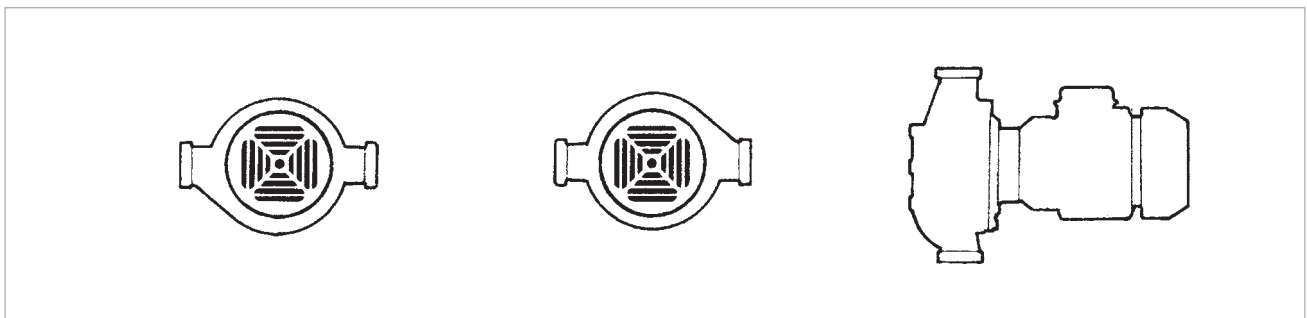

MCE/C INVERTER

MODES OF OPERATION

All the functions listed below can be consulted by the users (including less experienced ones) by simply scrolling through the MCE/C menu. The calibration and the modification of the parameters are protected, and can only be completed by expert users.

1 - ΔP -c constant differential pressure adjustment mode

The ΔP -c adjustment mode keeps the differential pressure of the system constantly at the H (setp) value set, even in case of variation of the flow rate. This is the standard adjustment used. It can be set directly from the MCE/C control panel. The inverter keeps the differential pressure (H setp) constant even in case of flow variation.

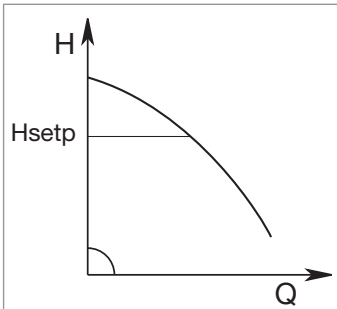

This adjustment is particularly indicated for the following systems:

- a. two-pipe heating systems with thermostat valves
- b. underfloor heating systems with thermostat valves
- c. single-pipe heating systems with thermostat valves and calibration valves
- d. systems with primary circuit pumps

2 - Constant curve adjustment modes

2.1 - Constant curve adjustment

The rotation speed is kept at a constant number of revolutions. This rotation speed can be set between a minimum value and the nominal frequency of the circulation pump (e.g. between 15 Hz and 50 Hz). This mode can be set using the control panel on the MCE cover.

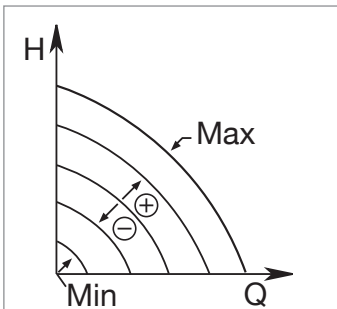

2.2 - Adjustment of the constant curve with external analogue signal

The rotation speed is kept at a constant number of revolution in proportion with the voltage of the external analogue signal.

The rotation speed changes in a linear way, between the nominal frequency of the pump when $V_{in} = 10$ V, and the minimum frequency when $V_{in} = 0$ V.

This mode can be set using the control panel on the MCE cover.

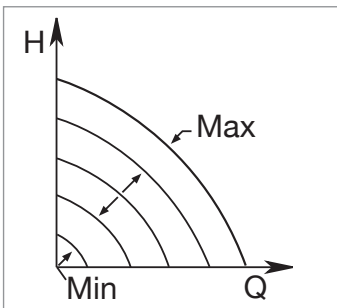

3 - ΔP -v * proportional differential pressure adjustment mode

With ΔP -v adjustment mode, with the variation of the flow rate, the value of the delivery of the head also varies in a linear manner, from Hsetp to Hsetp/2.

* in order to know the availability of the function on specific models contact our customer service.

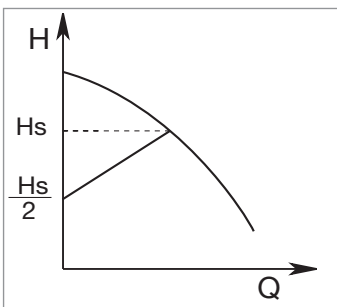

For more information refer to the technical appendix.

ELECTRIC IN-LINE PUMPS

ELECTRONIC IN-LINE PUMPS FOR CIRCULATION SYSTEMS

PERFORMANCE RANGE

The performance curves are based on kinematic viscosity values = 1 mm²/s and density equal to 1000 kg/m³. Curve tolerance according to ISO 9906.

GRAPHIC SELECTION TABLE

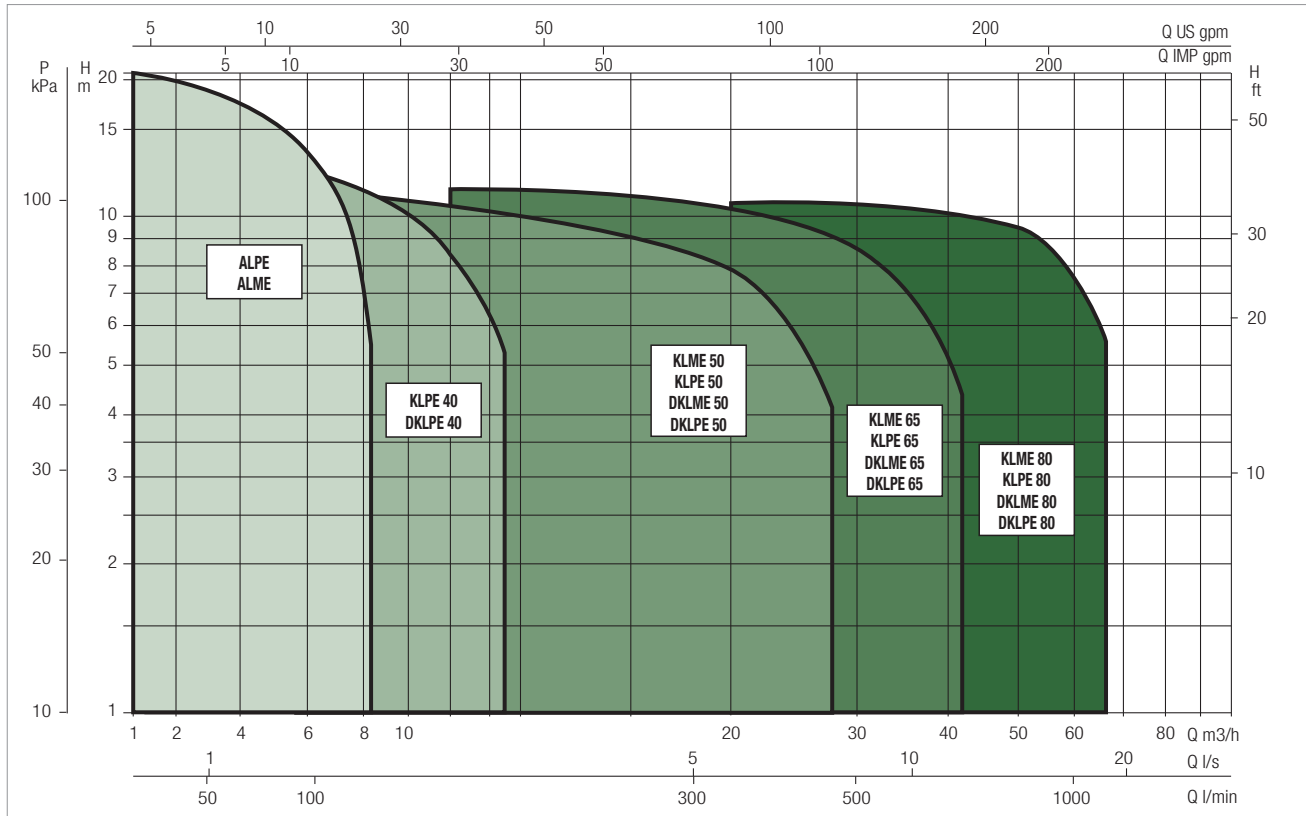

SELECTION TABLE - ALME / ALPE

MODEL	Q=m³/h	0	1,2	2,4	3,6	4,8	6	7,2	8,4
	Q=l/min	0	20	40	60	80	100	120	140
ALME 500 M MCE11/C	H (m)	5,5	5,4	5,3	4,8	4,1	3	1,5	
ALPE 2000 M MCE11/C		21,1	20,6	19,6	18	16	13,8	10,5	5,3

ALME 500 - IN-LINE ELECTRIC PUMPS FOR HEATING, AIR CONDITIONING, REFRIGERATION, SOLAR, AND SANITARY SYSTEMS - SINGLE, THREADED, WITH MCE/C INVERTER

Pumped liquid temperature range: from -15 °C to +120 °C - Maximum ambient temperature: +40°C

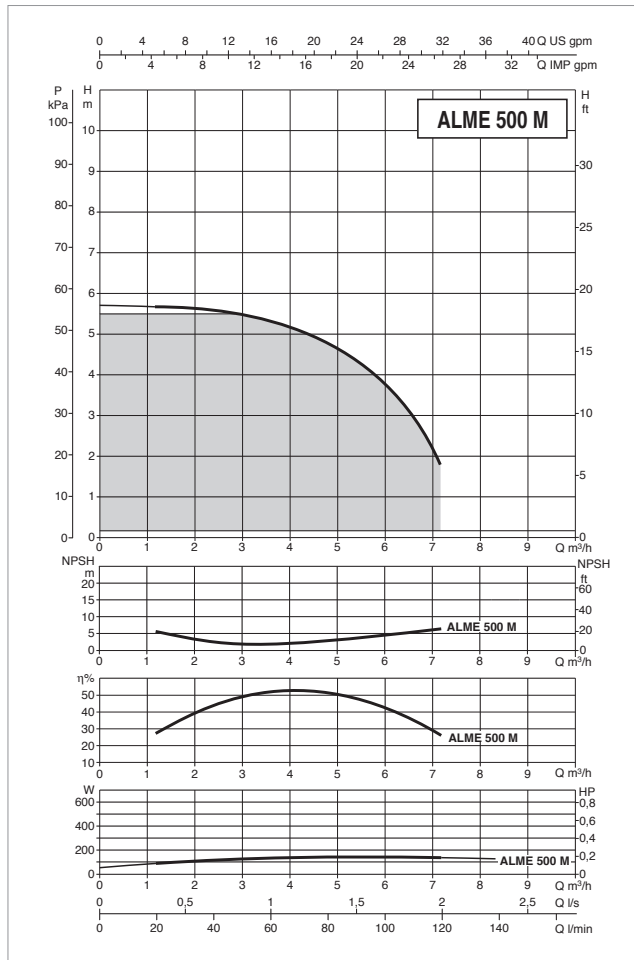
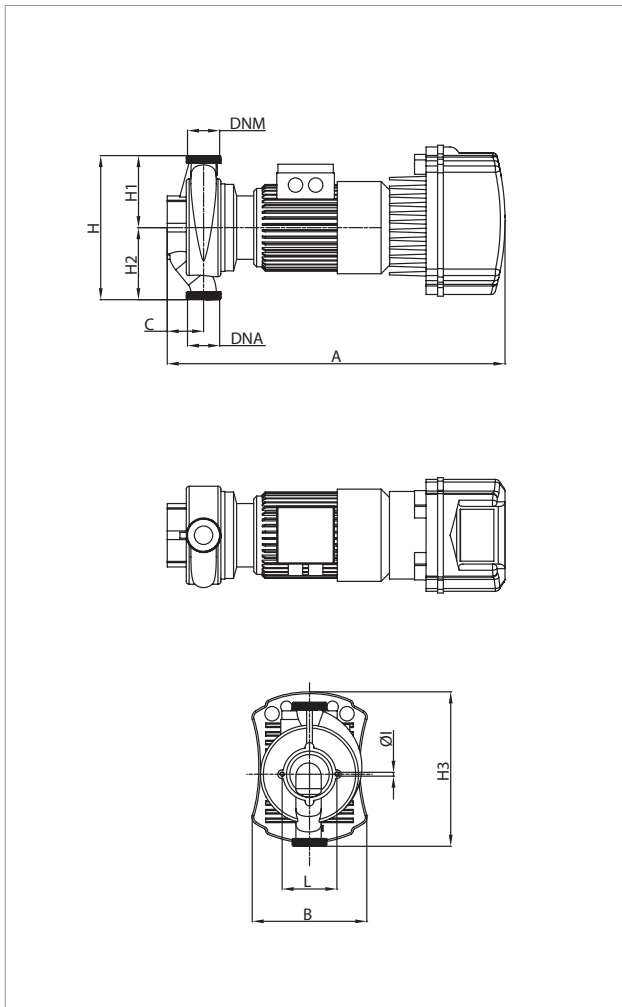

The performance curves are based on kinematic viscosity values = 1 mm²/s and density equal to 1000 kg/m³. Curve tolerance according to ISO 9906.

MODEL	ELECTRICAL DATA						
	POWER INPUT 50 Hz	MOTOR TYPE	n r.p.m.	P1 MAX W	P2 NOMINAL		In A
					kW	HP	
ALME 500 M MCE11/C *	1x220-240 V ~	4 POLES	1425	0,20	0,25	0,33	3,20

* Three-phase version on request

MODEL	A	B	C	L	Ø	H	H1	H2	H3	DNA	DNM	PACKING DIMENSIONS			VOLUME (m ³)	WEIGHT kg
												L/A	L/B	H		
ALME 500 M MCE11/C	586	200	63	95	8	250	125	125	256	2" M	2" M	600	234	275	0,039	19,5

ALPE 2000 IN-LINE ELECTRIC PUMPS FOR HEATING, AIR CONDITIONING, REFRIGERATION, SOLAR, AND SANITARY SYSTEMS - SINGLE, THREADED WITH MCE/C INVERTER

Pumped liquid temperature range: from -15 °C to +120 °C - Maximum ambient temperature: +40°C

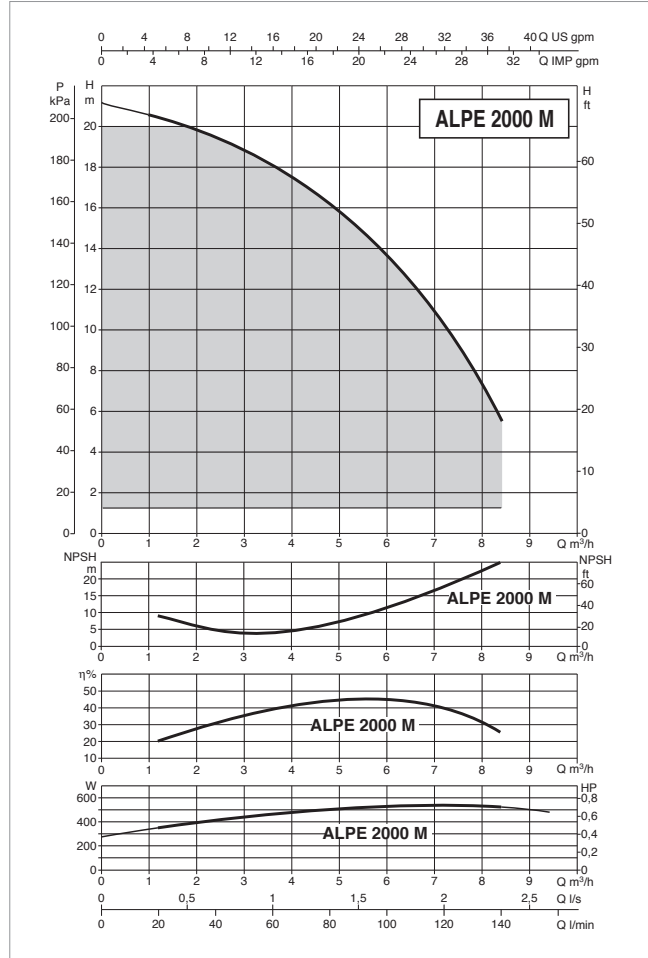
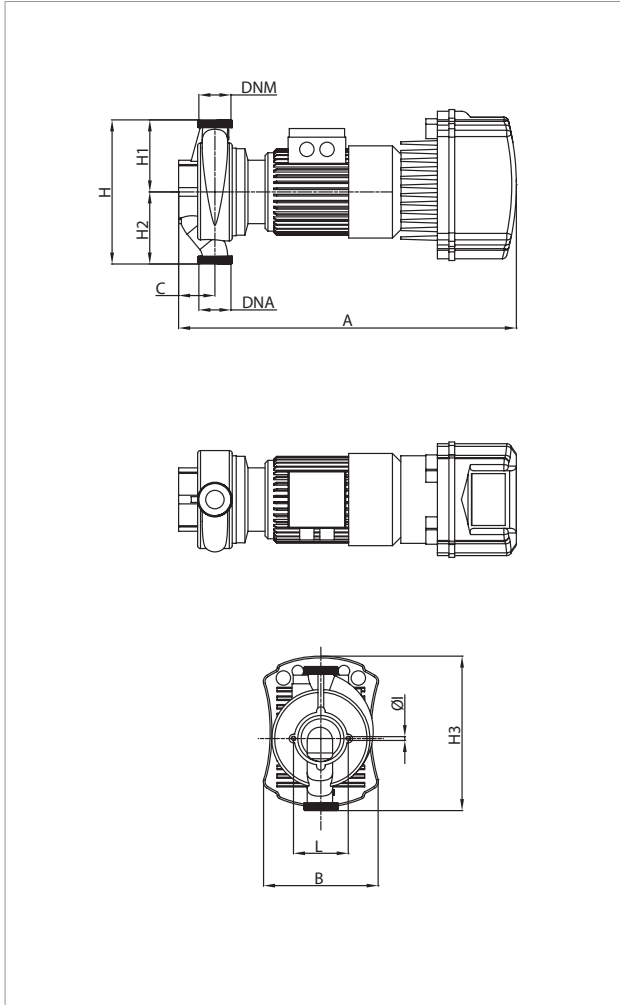

The performance curves are based on kinematic viscosity values = 1 mm²/s and density equal to 1000 kg/m³. Curve tolerance according to ISO 9906.

MODEL	ELECTRICAL DATA						
	POWER INPUT 50 Hz	MOTOR TYPE	n r.p.m.	P1 MAX W	P2 NOMINAL		In A
					kW	HP	
ALPE 2000 M MCE11/C *	1x220-240 V ~	2 POLES	2870	0,69	0,55	0,75	6,36

* Three-phase version on request

MODEL	A	B	C	L	Ø	H	H1	H2	H3	DNA	DNM	PACKING DIMENSIONS			VOLUME (m³)	WEIGHT kg
												L/A	L/B	H		
ALPE 2000 M MCE11/C	586	200	63	95	8	250	125	125	256	2" M	2" M	600	234	275	0,039	19,5