

DRB**motralec**

4 rue Lavoisier . ZA Lavoisier . 95223 HERBLAY CEDEX
 Tel. : 01.39.97.65.10 / Fax. : 01.39.97.68.48
 Demande de prix / e-mail : service-commercial@motralec.com
www.motralec.com



Special alloy pumps

General characteristics

- Special alloy pumps
- 0,37 ÷ 1,5 kW motor power
- 2 poles
- GAS 1 1/4" - 2" vertical delivery port
- max 15 mm free passage

Electromechanical assembly

Electromechanical assembly in B10 bronze, for submerged operation. Seal set comprising 1 (one) silicon carbide mechanical seal and 1 (one) graphite alumina mechanical seal, installed opposing with oil lubrication. Oil bath motor. Separate pump body. Series not available in explosion-proof version.

Applications

Suitable for treating chemically aggressive strained liquids, dyes and seawater. Can be used for applications in the tanning industry and the shipping sector.

Construction materials

Case	Bronze B10
Impeller	Bronze B10
Nuts and bolts	Stainless Steel - Class A4
Standard gasket	Rubber - VITON
Shaft	Stainless Steel - AISI 316
Set of standard mechanical seals	Two Silicon carbide mechanical seals (2SiC)

operating limits

Maximum operating temperature	40 °C
PH of treated fluid	5 to 10 pH
Viscosity of treated fluid	1 mm ² /s
Maximum immersion depth	20 m
Density of treated fluid	1 Kg/dm ³
Maximum acoustic pressure	70 dB
max starts per hour	20

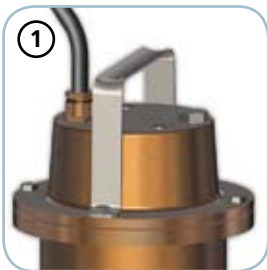
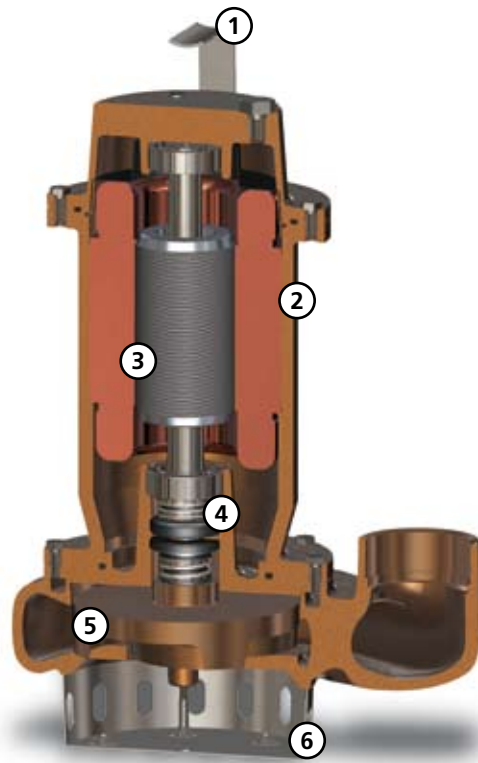

Handle
AISI 304 stainless steel lifting and carrying handle

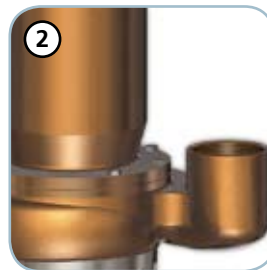

Structure
B10 bronze construction which makes the pump suitable for use with chemically aggressive liquids

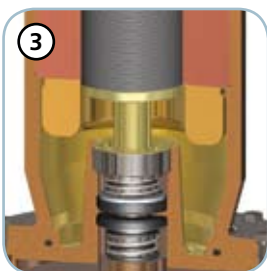

Motor
Oil-bath motor with thermal overloads



Mechanical seals
Two mechanical seals in silicon carbide (2SiC)

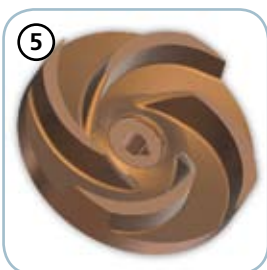

Impeller
Multichannel open impeller in B10 bronze

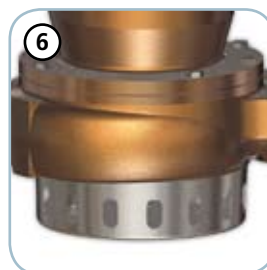

Intake strainer
Intake strainer in stainless steel

DRB

Models with vertical GAS 1 1/4" threaded delivery port - 2 poles

Performances

	l/s	0	1	2	3	4	5	6
	l/min	0	60	120	180	240	300	360
	m ³ /h	0	3,6	7,2	10,8	14,4	18,0	21,6
① DRB 50/2/G32V A0CM(T)/50		8,6	7,9	6,8	5,1	2,7		
② DRB 75/2/G32V A0CM(T)/50		11,9	11,5	10,5	8,9	6,8	4,1	1,0

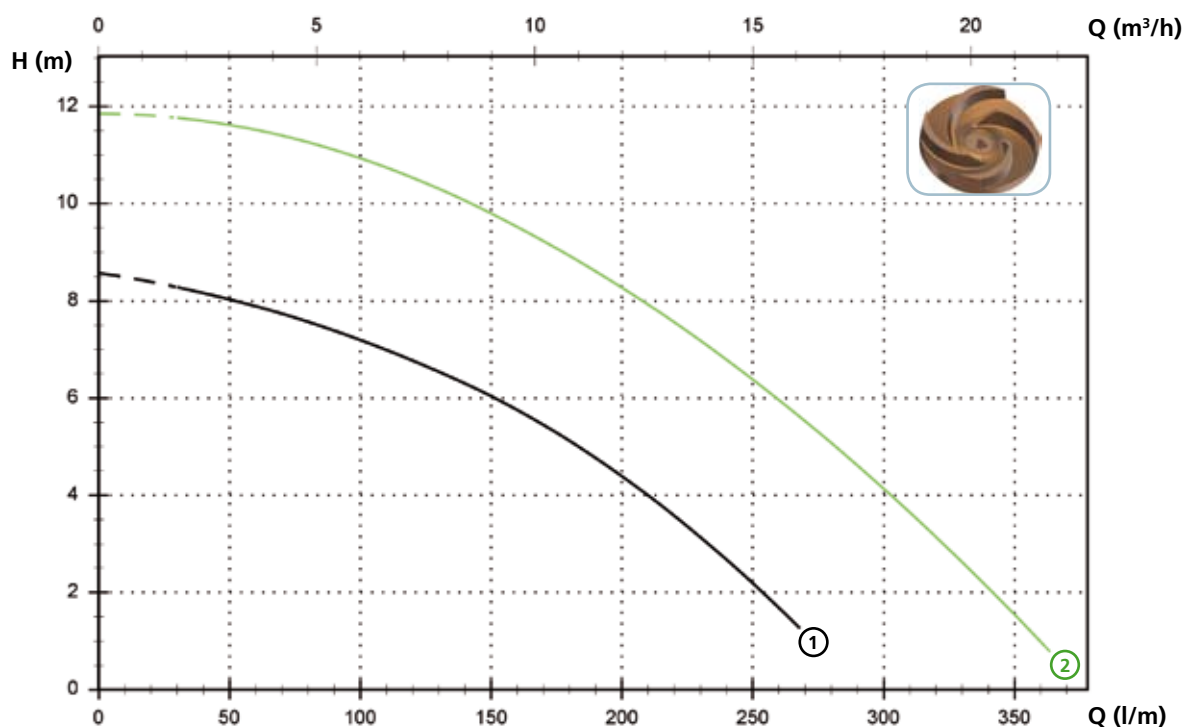

Technical data

	V	Phases	P1 (kW)	P2 (kW)	A	Rpm	Ø	Cable (*)	Free passage
① DRB 50/2/G32V A0CM/50	230	1	-	0.37	2.9	2900	G 1 1/4"	A	15 mm
② DRB 75/2/G32V A0CM/50	230	1	-	0.55	3.9	2900	G 1 1/4"	A	15 mm

	V	Phases	P1 (kW)	P2 (kW)	A	Rpm	Ø	Cable (*)	Free passage
① DRB 50/2/G32V A0CT/50	400	3	-	0.37	1.1	2900	G 1 1/4"	A	15 mm
② DRB 75/2/G32V A0CT/50	400	3	-	0.55	1.4	2900	G 1 1/4"	A	15 mm

(*) A = H07RN-F 4G1 - 10 m

Models with vertical GAS 2" threaded delivery port - 2 poles

Performances

<i>l/s</i>	0	2	4	6	8	10	12
<i>l/min</i>	0	120	240	360	480	600	720
<i>m³/h</i>	0	7,2	14,4	21,6	28,8	36,0	43,2

① DRB 100/2/G50V A0CM(T)/50	12,2	11,3	9,8	7,7	4,8		
② DRB 150/2/G50V A0CM(T)/50	15,9	14,9	13,5	11,7	9,1	5,9	
③ DRB 200/2/G50V A0CM(T)/50	18,0	16,8	15,4	13,5	11,2	8,4	4,9

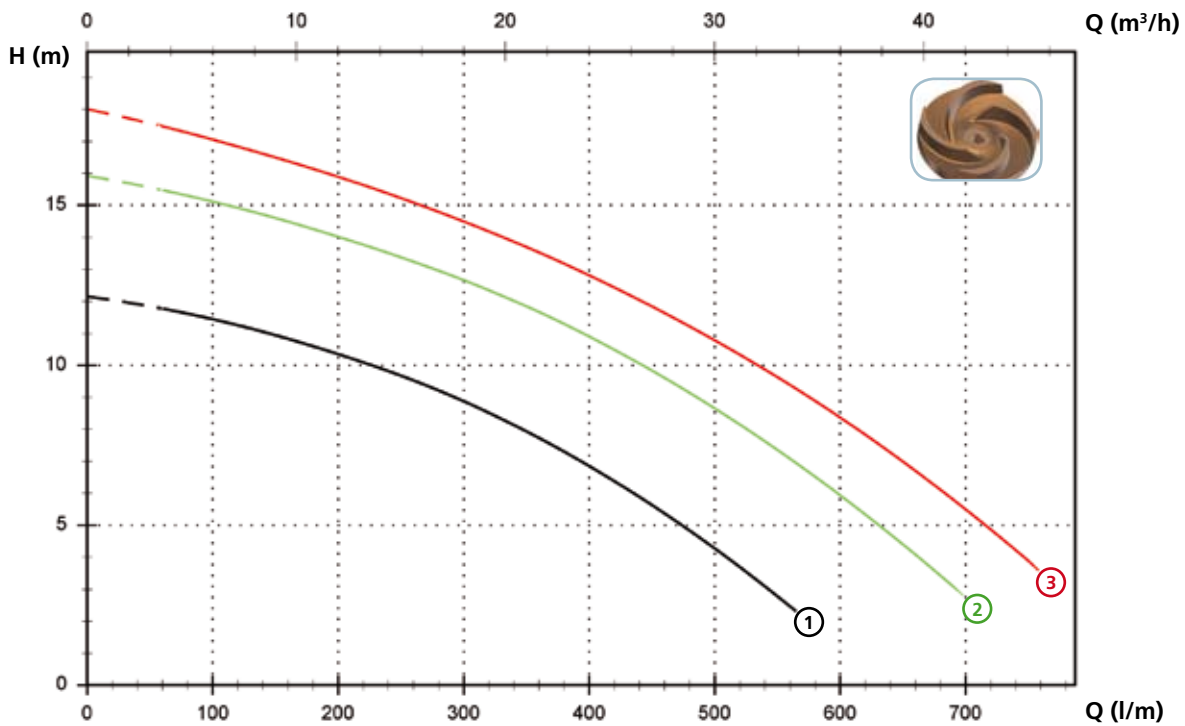

Technical data

	V	Phases	P1 (kW)	P2 (kW)	A	Rpm	Ø	Cable (*)	Free passage
① DRB 100/2/G50V A0CM/50	230	1	-	0.88	6.5	2900	G 2"	A	15 mm
② DRB 150/2/G50V A0CM/50	230	1	-	1.1	8.2	2900	G 2"	A	15 mm
③ DRB 200/2/G50V A0CM/50	230	1	-	1.5	9.3	2900	G 2"	A	15 mm

	V	Phases	P1 (kW)	P2 (kW)	A	Rpm	Ø	Cable (*)	Free passage
① DRB 100/2/G50V A0CT/50	400	3	-	0.88	2.3	2900	G 2"	A	15 mm
② DRB 150/2/G50V A0CT/50	400	3	-	1.1	2.7	2900	G 2"	A	15 mm
③ DRB 200/2/G50V A0CT/50	400	3	-	1.5	3.5	2900	G 2"	A	15 mm

(*) A = H07RN-F 4G1 - 10 m

DRB

Versions available

(Key to versions on page 15)

	Electrical variants													Cooling		Mechanical seals				
	N A E	T	T C	T C D	T C D T	T C D G T	T C G	T C S T	T C S G T	T S	T R	T R G	T R F T	C G F T	N	CC	2SIC	SICM	SICAL	2SICAL
DRB 50/2/G32V A0CM/50		●						●	●						●		●			
DRB 75/2/G32V A0CM/50		●						●	●						●		●			
DRB 100/2/G50V A0CM/50		●						●	●						●		●			
DRB 150/2/G50V A0CM/50		●						●	●						●		●			
DRB 200/2/G50V A0CM/50		●						●	●						●		●			
DRB 50/2/G32V A0CT/50	●														●		●			
DRB 75/2/G32V A0CT/50	●														●		●			
DRB 100/2/G50V A0CT/50	●														●		●			
DRB 150/2/G50V A0CT/50	●														●		●			
DRB 200/2/G50V A0CT/50	●														●		●			

Overall dimensions and weights

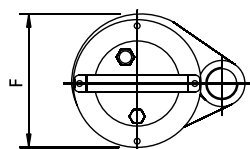
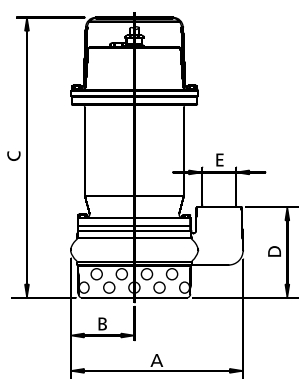

	A	B	C	D	E	F	kg
DRB 50/2/G32V A0CM(T)/50	210	75	340	110	G 1 1/4"	160	17
DRB 75/2/G32V A0CM (T)/50	210	75	340	110	G 1 1/4"	160	17
DRB 100/2/G50V A0CM (T)/50	265	100	390	125	G 2"	190	21
DRB 150/2/G50V A0CM (T)/50	265	100	390	125	G 2"	190	23
DRB 200/2/G50V A0CM (T)/50	265	100	390	125	G 2"	190	23

Measurements in mm

Packaging dimension

	A	B	C
DRB 50/2/G32V A0CM(T)/50	385	225	245
DRB 75/2/G32V A0CM(T)/50	385	225	245
DRB 100/2/G50V A0CM(T)/50	475	285	235
DRB 150/2/G50V A0CM(T)/50	475	285	235
DRB 200/2/G50V A0CM(T)/50	475	285	235

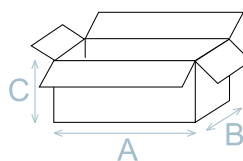

Dimension in mm

Installations available

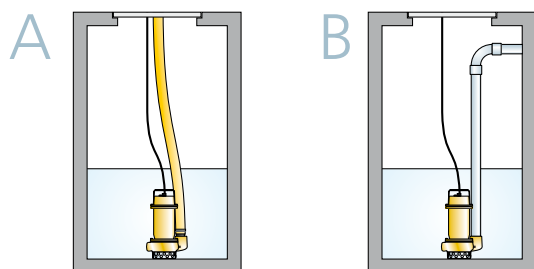

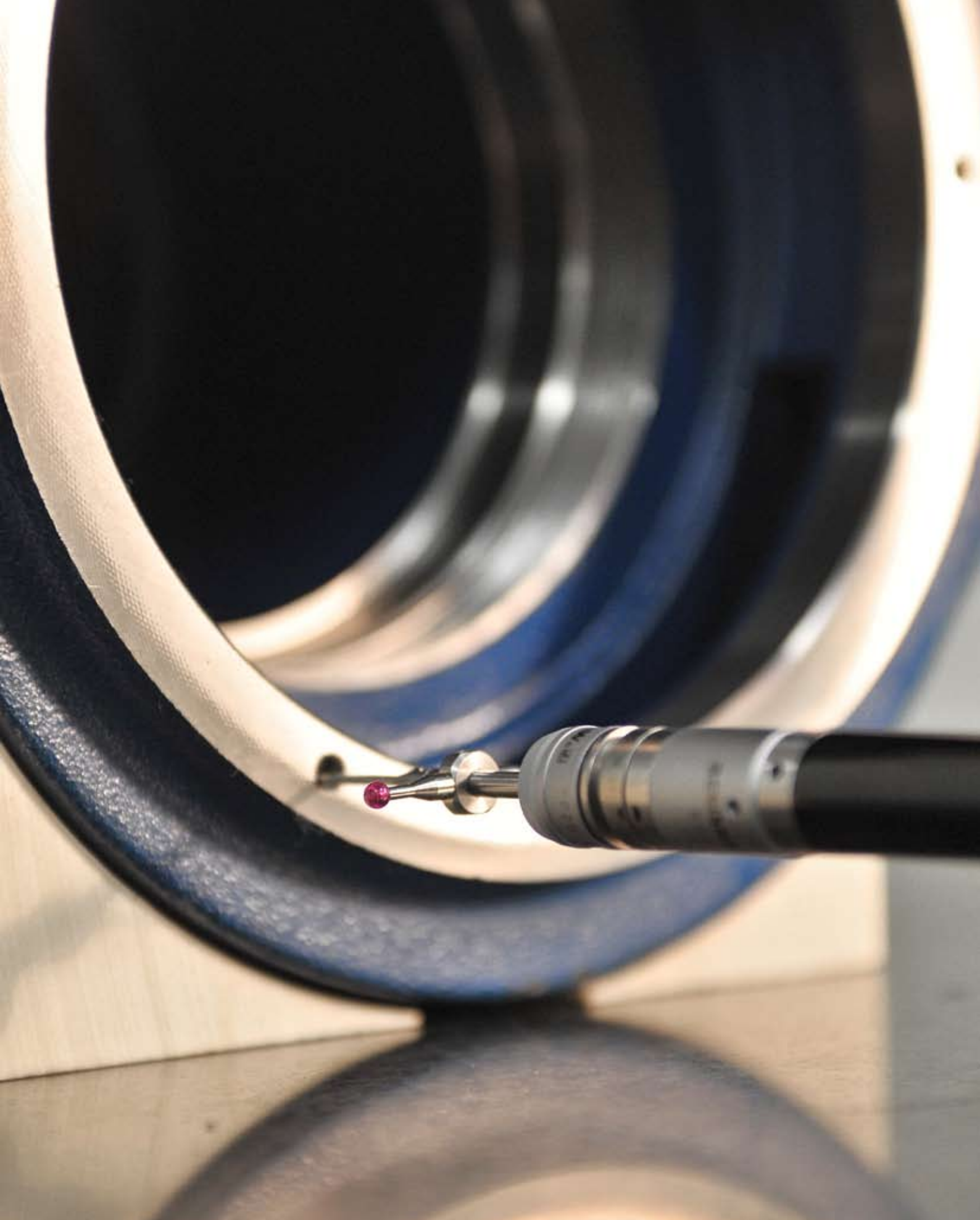

motralec

4 rue Lavoisier . ZA Lavoisier . 95223 HERBLAY CEDEX

Tel. : 01.39.97.65.10 / Fax. : 01.39.97.68.48

Demande de prix / e-mail : service-commercial@motralec.com

www.motralec.com