

# 5.0

## ELECTRIC AND ELECTRONIC ACCESSORIES



**motralec**

4 rue Lavoisier . ZA Lavoisier . 95223 HERBLAY CEDEX  
Tel. : 01.39.97.65.10 / Fax. : 01.39.97.68.48  
Demande de prix / e-mail : [service-commercial@motralec.com](mailto:service-commercial@motralec.com)  
[www.motralec.com](http://www.motralec.com)

# 5.1 ELECTROMECHANICAL AND ELECTRONIC CONTROL PANELS

Zenit electromechanical and electronic control panels are suitable for the management of any submersible electric pump, from 0.37 to 55 kW, single-phase, three-phase or star/delta.

They are designed for use with float switches and level gauges.

The vast array of standard products is accompanied by customised panels designed to meet specific customer needs.

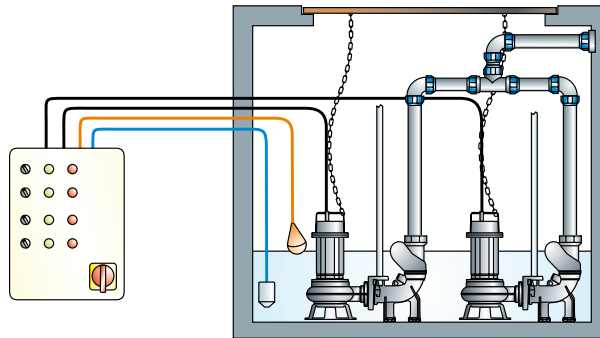

## Wiring done with care

All internal wiring is done in an extremely rational and clear manner.

The connection cables are identified with numbered labels for easy reference to the wiring diagram and to facilitate any interventions by technical personnel.

The attention given to the assembly translates into a qualitatively better product in which there is a lower risk of faults and malfunctions.

## Compliance to the standards

Every control panel is created in compliance with the current standards with regard to electrical constructions.

All control panels come with complete documentation, electric diagrams and CE declaration of conformity.

## Quality

The control panels are made using the best components available in order to guarantee excellent reliability and easy procurement of replacement parts.

They are subject to severe functional and quality checks before delivery.

## Advantages

Zenit electromechanical and electronic control panels are optimized for use with submersible pumps and the wide range of accessories make them versatile and reliable.

Having just one contact for the supplying of control systems and machines translates into definite advantages in economic terms and with regard to intervention times.



# Q1M

## Electromechanical control panel for 1 single-phase pump

### General characteristics



- Input voltage 1 ~ 50/60 Hz 230V ± 10%
- 230/24 V transformer for auxiliary circuits
- Blue light for power on (standard)
- Green light for motor running (standard)
- Red light for motor protection alarm (standard)
- 24 V AC line contactors, AC3 duty
- Auxiliary circuits protection fuse
- Motor protection fuses
- Main switch with safety door that can be locked in the OFF position
- Thermal relay for overload protection on every motor with internally resettable adjustable scale
- Very low voltage input for command from pressure switch or operating level float switch
- Very low voltage input for command from pressure switch or minimum level float switch
- Selector for AUTO-OFF-MANUAL motor operation (standard)
- ABS housing
- Output with cable holder
- IP55 protection rating

### Technical characteristics

	power		thermal protection	dimensions			weight
	kW	HP	rating (A)	A	B	P	Kg
Q1M 0402	0.37	0.5	3÷4.5	340	240	170	4
Q1M 0404	0.55	0.75	4.5÷6.5	340	240	170	4
Q1M 0406	0.75	1	6÷9	340	240	170	4
Q1M 0408	1.1	1.5	9÷10.5	340	240	170	4
Q1M 0410	1.5	2	9÷13.5	340	240	170	4
Q1M 0412	2.2	3	14÷18	340	240	170	4

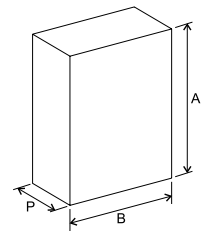

### Operating limits

Ambient temperature: -5/+40°C

50% relative humidity at 40°C (not condensed)

### Optional accessories

- 90 dB acoustic alarm - input command from float switch or pressure switch
- Flashing visual alarm - complete with input command terminals
- Acoustic alarm with buffer battery (involves box change)
- Kit of 3 level gauges for dry running protection
- Level control wired on the panel for water infiltration sensor
- 20 µF wired capacitor kit
- 30 µF wired capacitor kit
- 40 µF wired capacitor kit
- 50 µF wired capacitor kit
- 70 µF wired capacitor kit
- Wired voltmetric switch
- Wired ammetric switch complete with 3 TA
- Relay with terminal for alarm output
- Start/stop kit for 2 float switches
- Kit for 24V electrovalve output controlled by float or pressure switch
- 500V F.S. voltmeter (wired)
- 25 A F.S. ammeter (wired)
- 60 A F.S. ammeter (wired)
- 100 A F.S. ammeter (wired)
- Mushroom-head emergency stop button (wired)

# Q2M

## Electromechanical control panel for 2 single-phase pumps

### General characteristics



- Input voltage 1 ~ 50/60 Hz 230V ± 10%
- Input for command from pressure switch or float switch protecting against dry running
- 230/24 V transformer for auxiliary circuits
- Selectors for AUTO-OFF-MANUAL motor operation (standard)
- Blue light for power on (standard)
- Green light for motor running (standard)
- Red light for motor protection alarm (standard)
- 2 24V AC line contactors, AC3 duty
- Main switch with door lock
- Thermal relay for overload protection on every motor with internally resettable adjustable scale
- Very low voltage input for command from pressure switch or float switch
- Thermoplastic housing
- IP55 protection rating

### Technical characteristics

	power		thermal protection rating (A)	dimensions			weight Kg
	kW	HP		A	B	P	
Q2M 0602	0.37	0.5	3÷4.5	420	300	150	7
Q2M 0604	0.55	0.75	4.5÷6.5	420	300	150	7
Q2M 0606	0.75	1	6÷9	420	300	150	7
Q2M 0608	1.1	1.5	9÷10.5	420	300	150	7
Q2M 0610	1.5	2	9÷13.5	420	300	150	7
Q2M 0612	2.2	3	14÷18	420	300	150	7

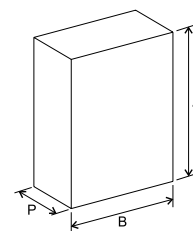

Contact Customer Service for higher power electric control panels

### Operating limits

Ambient temperature: -5/+40°C

50% relative humidity at 40°C (not condensed)

### Optional accessories

- 24V Undecal pump alternation relay~
- 90 dB acoustic alarm - input command from float switch or pressure switch
- Visual alarm - complete with input command terminals
- Acoustic alarm with buffer battery (involves box change)
- Kit of 3 level gauges for dry running protection
- Wired level control
- Relay with terminal for alarm output
- Start/stop kit for 2 float switches
- Kit for 24V electrovalve output controlled by float or pressure switch
- 500 V F.S. voltmeter kit (wired)
- 25 A F.S. ammeter kit (wired)
- 40 A F.S. ammeter kit (wired)
- 60 A F.S. ammeter kit (wired)
- 100 A F.S. ammeter kit (wired)
- Voltmetric switch
- Ammetric switch complete with 3 TA
- Start/stop button
- Mushroom-head emergency stop button (wired)

# Q3M

## Electromechanical control panel for 3 single-phase pumps

### General characteristics



- Input voltage 1 ~ 50/60 Hz 230V ± 10%
- 230/24 V transformer for auxiliary circuits
- Very low voltage input for command from pressure switch or float switch
- Input for command from pressure switch or float switch protecting against dry running
- 230/24 V transformer for auxiliary circuits
- 3 selectors for AUTO-OFF-MANUAL motor operation (standard)
- Blue light for power on (standard)
- 3 green lights for motor running (standard)
- 3 red lights for motor protection alarm (standard)
- 24 V AC line contactors, AC3 duty
- Thermal relays for overload protection on every motor with internally resettable adjustable scale
- Main switch with door lock
- Metal housing
- Output with cable holder
- IP55 protection rating

### Technical characteristics

	power		thermal protection rating (A)	dimensions			weight Kg
	kW	HP		A	B	P	
Q3M 0802	0.37	0.5	3÷4.5	540	400	230	14
Q3M 0804	0.55	0.75	4.5÷6.5	540	400	230	14
Q3M 0806	0.75	1	6÷9	540	400	230	14

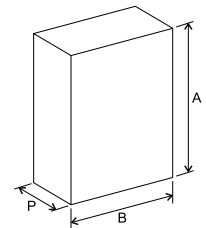

Contact Customer Service for higher power electric control panels

### Operating limits

Ambient temperature: -5/+40°C  
50% relative humidity at 40°C (not condensed)

### Optional accessories

- 24V Undecal 2 pump alternation relay~
- 24V Undecal 3 pump alternation relay~
- 90 dB acoustic alarm - input command from float switch or pressure switch
- Visual alarm - complete with input command terminals
- Kit of 3 level gauges for dry running protection
- Wired level control
- Relay with terminal for alarm output
- 500 V F.S. voltmeter kit (wired)
- 25 A F.S. ammeter kit (wired)
- 40 A F.S. ammeter kit (wired)
- 60 A F.S. ammeter kit (wired)
- 100 A F.S. ammeter kit (wired)
- Voltmetric switch
- Ammetric switch complete with 3 TA
- Mushroom-head emergency stop button (wired)

# Q1T

## Electromechanical control panel for 1 three-phase pump

### General characteristics



- Input voltage 1 ~ 50/60 Hz 230V ± 10%
- 230/24 V transformer for auxiliary circuits
- Selector for AUTO-OFF-MANUAL motor operation (standard)
- Blue light for power on (standard)
- Green light for motor running (standard)
- Red light for motor protection alarm (standard)
- 24 V AC line contactors, AC3 duty
- Auxiliary circuits protection fuse
- Motor protection fuses
- Main switch with safety door that can be locked in the OFF position
- Thermal relay for overload protection on every motor with internally resettable adjustable scale
- Very low voltage input for command from pressure switch or operating level float switch
- Very low voltage input for command from pressure switch or minimum level float switch
- ABS housing
- Output with cable holder
- IP55 protection rating

### Technical characteristics

	power		thermal protection rating (A)	dimensions			weight Kg
	kW	HP		A	B	P	
Q1T 1014	0.37	0.5	0.9÷1.3	340	240	170	4
Q1T 1016	0.55	0.75	1.4÷2	340	240	170	4
Q1T 1018	0.75÷1.1	1÷1.5	2÷3.2	340	240	170	4
Q1T 1020	1.5	2	3÷4.5	340	240	170	4
Q1T 1022	2.2	3	4.5÷6.8	340	240	170	4
Q1T 1024	3.7	5.5	6÷9	340	240	170	4
Q1T 1026	5.5	7.5	9÷12	340	240	170	4.5
Q1T 1028	7.5	10	14÷16	340	240	170	4.5
Q1T 1030	9.2	12.5	14÷20	340	240	170	4.5
Q1T 1032	11	15	17÷25	340	240	170	5.5
Q1T 1034	15	20	20÷32	420	300	150	12

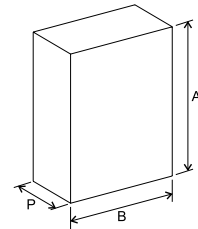

Contact Customer Service for higher power electric control panels

### Operating limits

Ambient temperature: -5/+40°C

50% relative humidity at 40°C (not condensed)

### Optional accessories

- 90 dB acoustic alarm - input command from float switch or pressure switch
- Flashing visual alarm - complete with input command terminals
- Acoustic alarm with buffer battery (involves box change)
- Kit of 3 level gauges for dry running protection
- Level control wired on the panel for water infiltration sensor
- 20 µF wired capacitor kit
- 30 µF wired capacitor kit
- 40 µF wired capacitor kit
- 50 µF wired capacitor kit
- 70 µF wired capacitor kit
- Wired voltmeter switch
- Wired ammeter switch complete with 3 TA
- Relay with terminal for alarm output
- Start/stop kit for 2 float switches
- Kit for 24V electrovalve output controlled by float or pressure switch
- 500V F.S. voltmeter (wired)
- 25 A F.S. ammeter (wired)
- 60 A F.S. ammeter (wired)
- 100 A F.S. ammeter (wired)
- Mushroom-head emergency stop button (wired)

# Q2T

## Electromechanical control panel for 2 three-phase pumps

### General characteristics



- Input voltage 3 ~ 50/60 Hz 400V ± 10%
- Input for command from pressure switch or float switch protecting against dry running
- 400/24 V transformer for auxiliary circuits
- Selectors for AUTO-OFF-MANUAL motor operation (standard)
- Blue light for power on (standard)
- Green light for motor running (standard)
- Red light for motor protection alarm (standard)
- 2 24V AC line contactors, AC3 duty
- Very low voltage input for command from pressure switch or float switch
- Thermal relay for overload protection on every motor with internally resettable adjustable scale
- Main switch with door lock
- Thermoplastic housing
- IP55 protection rating

### Technical characteristics

	power		thermal protection	dimensions			weight
	kW	HP	rating (A)	A	B	P	Kg
Q2T 1214	0.37	0.5	0.9÷1.3	420	300	150	7
Q2T 1216	0.55	0.75	1.4÷2	420	300	150	7
Q2T 1218	1.1	1.5	2÷3.2	420	300	150	7
Q2T 1220	1.5	2	3÷4.5	420	300	150	7
Q2T 1222	2.2	3	4.5÷6.8	420	300	150	7
Q2T 1224	3.7	5.5	6÷9	420	300	150	7
Q2T 1226	5.5	7.5	9÷12	420	300	150	7
Q2T 1228	7.5	10	14÷16	420	300	150	8
Q2T 1230	9.2	12.5	14÷20	420	300	150	8
Q2T 1232	11	15	17÷25	420	300	150	14.5
Q2T 1234	15	20	20÷32	530	400	230	14.5

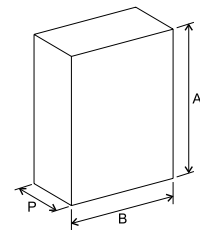

Contact Customer Service for higher power electric control panels

### Operating limits

Ambient temperature: -5/+40°C  
 50% relative humidity at 40°C (not condensed)

### Optional accessories

- 24V Undecal pump alternation relay~
- 90 dB acoustic alarm - input command from float switch or pressure switch
- Visual alarm - complete with input command terminals
- Acoustic alarm with buffer battery (involves box change)
- Kit of 3 level gauges for dry running protection
- Wired level control
- Relay with terminal for alarm output
- Start/stop kit for 2 float switches
- Kit for 24V electrovalve output controlled by float or pressure switch
- 500 V F.S. voltmeter kit (wired)
- 25 A F.S. ammeter kit (wired)
- 40 A F.S. ammeter kit (wired)
- 60 A F.S. ammeter kit (wired)
- 100 A F.S. ammeter kit (wired)
- Voltmetric switch
- Ammetric switch complete with 3 TA
- Start/stop button
- Mushroom-head emergency stop button (wired)

# Q3T

## Electromechanical control panel for 3 three-phase pumps

### General characteristics



- Input voltage 1 ~ 50/60 Hz 230V  $\pm$  10%
- 230/24 transformer for auxiliary circuits
- Very low voltage input for command from pressure switch or float switch
- Input for command from pressure switch or float switch protecting against dry running
- 230/24 V transformer for auxiliary circuits
- 3 selectors for AUTO-OFF-MANUAL motor operation (standard)
- Blue light for power on (standard)
- 3 green lights for motor running (standard)
- 3 red lights for motor protection alarm (standard)
- 24 V AC line contactors, AC3 duty
- Thermal relays for overload protection on every motor with internally resettable adjustable scale
- Main switch with door lock
- Metal housing
- Output with cable holder
- IP55 protection rating

### Technical characteristics

	power		thermal protection rating (A)	dimensions			weight Kg
	kW	HP		A	B	P	
Q3T 1414	0.37	0.5	0.9÷1.3	540	400	230	14
Q3T 1416	0.55	0.75	1.4÷2	540	400	230	14
Q3T 1418	0.75÷1.1	1÷1.5	2÷3.2	540	400	230	14
Q3T 1420	1.5	2	3÷4.5	540	400	230	14
Q3T 1422	2.2	3	4.5÷6.8	540	400	230	14
Q3T 1424	3÷4	4÷5.5	6÷9	540	400	230	14
Q3T 1426	5.5	7.5	9÷12	540	400	230	14
Q3T 1428	7.5	10	10÷16	540	400	230	15
Q3T 1430	11	15	15÷20	540	400	230	15
Q3T 1432	15	20	24÷31	540	400	230	15

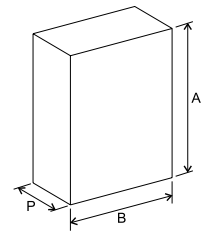

Contact Customer Service for higher power electric control panels

### Operating limits

Ambient temperature: -5/+40°C

50% relative humidity at 40°C (not condensed)

### Optional accessories

- 24V Undecal 2 pump alternation relay~
- 24V Undecal 3 pump alternation relay~
- 90 dB acoustic alarm - input command from float switch or pressure switch
- Visual alarm - complete with input command terminals
- Kit of 3 level gauges for dry running protection
- Wired level control
- Relay with terminal for alarm output
- 500 V F.S. voltmeter kit (wired)
- 25 A F.S. ammeter kit (wired)
- 40 A F.S. ammeter kit (wired)
- 60 A F.S. ammeter kit (wired)
- 100 A F.S. ammeter kit (wired)
- Voltmetric switch
- Ammetric switch complete with 3 TA
- Mushroom-head emergency stop button (wired)



# Q1ST

## Star/delta electromechanical control panel for 1 three-phase pump

### General characteristics



- Input voltage 3 ~ 50/60 Hz 400V ± 10%
- Very low voltage input for command from pressure switch or float switch
- Input for command from pressure switch or float switch protecting against dry running
- 400/24 V transformer for auxiliary circuits
- Selector for AUTO-OFF-MANUAL motor operation (standard)
- Blue light for power on (standard)
- Green light for motor running (standard)
- Red light for motor protection alarm (standard)
- Line contactor, AC3 duty
- Star contactor, AC3 duty
- Delta contactor, AC3 duty
- Adjustable star-delta changeover timer 0÷30"
- Thermal relay for overload protection on every motor with internally resettable adjustable scale
- Motor protection fuses
- Auxiliary circuits protection fuse
- Main switch with door lock
- Thermoplastic (up to 15 HP) or metallic housing
- Output with cable holder
- IP 55 protection rating

### Technical characteristics

	power		thermal protection	dimensions			weight
	kW	HP	rating (A)	A	B	P	Kg
Q1ST 2036	2.2	3	5÷8	420	320	170	6
Q1ST 2038	4	5.5	8÷11.5	420	320	170	6
Q1ST 2040	5.5	7.5	10÷14	420	320	170	6
Q1ST 2042	7.5	10	10÷16	420	320	170	6
Q1ST 2044	11	15	15÷20	420	320	170	6
Q1ST 2046	15	20	24÷31	530	400	230	16
Q1ST 2048	18.5	25	24÷36	530	400	230	16
Q1ST 2050	22	30	34÷50	530	400	230	16
Q1ST 2052	30	40	48÷62	530	400	230	20
Q1ST 2054	37	50	60÷77	630	500	230	30
Q1ST 2056	45	60	79÷98	630	500	230	30

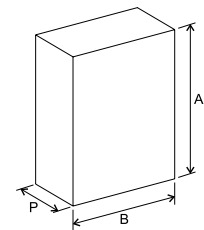

Contact Customer Service for higher power electric control panels

### Operating limits

Ambient temperature: -5/+40°C  
50% relative humidity at 40°C (not condensed)

### Optional accessories

- 90 dB acoustic alarm - input command from float switch or pressure switch
- Visual alarm - complete with input command terminals
- Acoustic alarm with buffer battery (involves box change)
- Kit of 3 level gauges for dry running protection
- Wired level control
- 500 V F.S. voltmeter kit (wired)
- 25 A F.S. ammeter kit (wired)
- 40 A F.S. ammeter kit (wired)
- 60 A F.S. ammeter kit (wired)
- 100 A F.S. ammeter kit (wired)
- 150 A F.S. ammeter kit (wired)
- 200 A F.S. ammeter kit (wired)
- Voltmetric switch
- Ammetric switch complete with 3 TA
- Relay with terminal for alarm output
- Control of sequence and lack of phases (wired)
- Min/max voltage control relay (wired)
- Start/stop button
- Mushroom-head emergency stop button (wired)

# Q2ST

## Star/delta electromechanical control panel for 2 three-phase pumps

### General characteristics



- Input voltage 3 ~ 50/60 Hz 400V ± 10%
- Input for command from pressure switch or float switch protecting against dry running
- 400V/24V transformer for auxiliary circuits
- 2 selectors for AUTO-OFF-MANUAL motor operation (standard)
- Blue light for power on (standard)
- 2 green lights for motor running (standard)
- 2 red lights for motor protection alarm (standard)
- 2 24V AC line contactors, AC3 duty
- 2 24V AC star contactors, AC3 duty
- 2 24V AC delta contactors, AC3 duty
- 2 adjustable star-delta changeover timers 0÷30"
- Very low voltage input for command from 2 pressure switches or float switches
- Thermal relays for overload protection on every motor with internally resettable adjustable scale
- Motor protection fuses
- Auxiliary circuits protection fuse
- Main switch with door lock
- Metal housing
- Output with cable holder
- IP55 protection rating

### Technical characteristics

	power		thermal protection rating (A)	dimensions			weight Kg
	kW	HP		A	B	P	
Q2ST 2236	2.2	3	5÷8	630	400	230	12
Q2ST 2238	4	5.5	8÷11.5	630	400	230	12
Q2ST 2240	5.5	7.5	10÷14	630	400	230	12
Q2ST 2242	7.5	10	10÷16	630	400	230	12
Q2ST 2244	11	15	15÷20	630	400	230	12
Q2ST 2246	15	20	24÷31	690	500	230	32
Q2ST 2248	18.5	25	24÷36	740	500	230	40
Q2ST 2250	22	30	34÷50	740	500	230	40
Q2ST 2252	30	40	48÷62	840	600	330	60
Q2ST 2254	37	50	60÷77	840	600	330	60
Q2ST 2256	45	60	79÷98	840	600	330	80

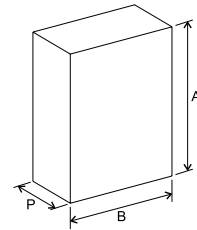

Contact Customer Service for higher power electric control panels

### Operating limits

Ambient temperature: -5/+40°C

50% relative humidity at 40°C (not condensed)

Maneuvers/hour frequency: a maximum of 4 of which not more than 2 consecutively

### Optional accessories

- 24V Undecal pump alternation relay~
- 90 dB acoustic alarm - input command from float switch or pressure switch
- Visual alarm - complete with input command terminals
- Acoustic alarm with buffer battery (involves box change)
- Kit of 3 level gauges for dry running protection
- Wired level control
- Relay with terminal for alarm output
- 500 V F.S. voltmeter kit (wired)
- 25 A F.S. ammeter kit (wired)
- 40 A F.S. ammeter kit (wired)
- 60 A F.S. ammeter kit (wired)
- 100 A F.S. ammeter kit (wired)
- Voltmetric switch
- Ammetric switch complete with 3 TA
- Control of sequence and lack of phases
- Min/max voltage control relay
- Start/stop button
- Mushroom-head emergency stop button (wired)

# Q3ST

## Star/delta electromechanical control panel for 3 three-phase pumps

### General characteristics



- Input voltage 3 ~ 50/60 Hz 400V ± 10%
- 400/24 transformer for auxiliary circuits
- Very low voltage input for command from pressure switch or float switch
- Input for command from pressure switch or float switch protecting against dry running
- 230/24 V transformer for auxiliary circuits
- 3 selectors for AUTO-OFF-MANUAL motor operation (standard)
- Blue light for power on (standard)
- 3 green lights for motor running (standard)
- 3 red lights for motor protection alarm (standard)
- 3 24V AC line contactors, AC3 duty
- 3 24V AC star contactors, AC3 duty
- 3 24V AC delta contactors, AC3 duty
- 3 adjustable star-delta changeover timers 0-30"
- Thermal relays for overload protection on every motor with internally resettable adjustable scale
- Motor protection fuses
- Auxiliary circuits protection fuse
- Main switch with door lock
- Metal housing
- IP55 protection rating

### Technical characteristics

	power		thermal protection rating (A)	dimensions			weight Kg
	kW	HP		A	B	P	
Q3ST 2436	2.2	3	5÷8	630	400	230	12
Q3ST 2438	4	5.5	8÷11.5	630	400	230	12
Q3ST 2440	5.5	7.5	10÷14	630	400	230	12
Q3ST 2442	7.5	10	10÷16	630	400	230	12
Q3ST 2444	11	15	15÷20	630	400	230	12
Q3ST 2446	15	20	24÷31	740	500	230	32
Q3ST 2448	18.5	25	24÷36	840	600	230	40
Q3ST 2450	22	30	34÷50	840	600	230	40
Q3ST 2452	30	40	48÷62	1040	800	330	60
Q3ST 2454	37	50	60÷77	1040	800	330	70
Q3ST 2456	45	60	79÷98	1040	800	330	80

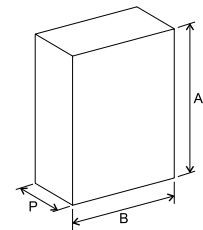

Contact Customer Service for higher power electric control panels

### Operating limits

Ambient temperature: -5/+40°C  
50% relative humidity at 40°C (not condensed)

### Optional accessories

- Pump alternation relay
- 90 dB acoustic alarm - input command from float switch or pressure switch
- Visual alarm - complete with input command terminals
- Acoustic alarm with buffer battery (involves box change)
- Kit of 3 level gauges for dry running protection
- Wired level control
- Relay with terminal for alarm output
- 500 V F.S. voltmeter kit (wired)
- 25 A F.S. ammeter kit (wired)
- 40 A F.S. ammeter kit (wired)
- 60 A F.S. ammeter kit (wired)
- 100 A F.S. ammeter kit (wired)
- Voltmetric switch
- Ammetric switch complete with 3 TA
- Control of sequence and lack of phases
- Min/max voltage control relay
- Start/stop button
- Mushroom-head emergency stop button (wired)



# Q1EL M

## Electronic control panel for 1 single-phase pump

### General characteristics



- Power supply 1~ 50/60Hz 230V +/- 10%
- Very low voltage input for command from pressure switch or float switch
- Very low voltage input for external command from 3 minimum level gauges
- Ideal for used with sensors for non-flammable conductive liquids (not included)
- Selector for the operation of filling/draining sensors
- Internal sensor sensitivity regulator
- Buttons for "Automatic-Off-Manual" motor operation
- Green "Power On" LED
- Green "Automatic Operation" LED
- Green "motor running" LED
- Red "level alarm" LED
- Red "motor overload protection alarm" LED
- Protection reset button
- Adjustable electronic protection for motor overload
- Time for protection activation: 5"
- Motor protection fuses
- Auxiliary circuits protection fuse
- Alarm output with N.O.-C-N.C. changeover contacts (16A 250V resistive load capacity)
- Main switch with door lock
- Set up for insertion of a capacitor
- ABS housing
- Output with cable holder
- IP55 protection rating

### Technical characteristics

	power		thermal protection rating (A)	dimensions			weight Kg
	kW	HP		A	B	P	
Q1 EL M	0.37÷2.2	0.5÷3	2÷16	340	240	170	1.5

Contact Customer Service for higher power electric control panels

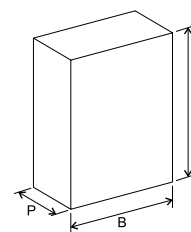

### Operating limits

Ambient temperature: -5/+40°C

50% relative humidity at 40°C (not condensed)

### Optional accessories

- 90 dB acoustic alarm - input command from float switch or pressure switch
- Flashing visual alarm - complete with input command terminals
- Acoustic alarm with buffer battery (involves box change)
- Kit of 3 level gauges for dry running protection
- 20 µF wired capacitor kit
- 30 µF wired capacitor kit
- 40 µF wired capacitor kit
- 50 µF wired capacitor kit
- 70 µF wired capacitor kit

# Q2EL M

## Electronic control panel for 2 single-phase pumps

### General characteristics



- Power supply 1~ 50/60Hz 400V +/- 10%
- Very low voltage input for command from 2 pressure switches or float switches
- Very low voltage input for command from pressure switch or level alarm float switch
- Very low voltage input for external command from 3 minimum level gauges
- Built-in pump alternation circuit with 4" startup delay
- Internal selector for pump alternation exclusion
- Selector for the operation of filling/draining sensors
- 2 selectors for "Automatic-Off-Manual" motor operation
- Green "Power On" LED
- 2 green "Automatic Operation" LEDs
- 2 green "motor running" LEDs
- Red "level alarm" LED
- 2 red "motor overload protection alarm" LEDs
- Time for protection activation: 5"
- Protection reset button
- Internal sensor sensitivity regulator
- Adjustable amperage protection for motor overload
- Motor protection fuses
- Auxiliary circuits protection fuse
- Alarm output with N.O.-C-N.C. changeover contacts (16A 250V resistive load capacity)
- Main switch with door lock
- Output with cable holder
- ABS housing
- IP55 protection rating

### Technical characteristics

	power		thermal protection rating (A)	dimensions			weight Kg
	kW	HP		A	B	P	
Q2 EL M	0.37÷2.2	0.5÷3	2÷16	340	240	170	3

Contact Customer Service for higher power electric control panels

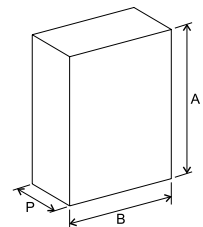

### Operating limits

Ambient temperature: -5/+40°C  
50% relative humidity at 40°C (not condensed)

### Optional accessories

- 90 dB acoustic alarm - input command from float switch or pressure switch
- Flashing visual alarm - complete with input command terminals
- Acoustic alarm with buffer battery (involves box change)
- Kit of 3 level gauges for dry running protection

# Q1EL T

## Electronic control panel for 1 three-phase pump

### General characteristics



- Power supply 3~ 50/60Hz 400V +/- 10%
- Very low voltage input for command from pressure switch or float switch
- Very low voltage input for external command from 3 minimum level gauges
- Ideal for used with sensors for non-flammable conductive liquids (not included)
- Selector for the operation of filling/draining sensors
- Internal sensor sensitivity regulator
- Buttons for "Automatic-Off-Manual" motor operation
- Green "Power On" LED
- Green "Automatic Operation" LED
- Green "motor running" LED
- Red "level alarm" LED
- Red "motor overload protection alarm" LED
- Protection reset button
- Adjustable electronic protection for motor overload
- Time for protection activation: 5"
- Motor protection fuses
- Auxiliary circuits protection fuse
- Alarm output with N.O.-C-N.C. changeover contacts (16A 250V resistive load capacity)
- Main switch with door lock
- ABS housing
- Output with cable holder
- IP55 protection rating

### Technical characteristics

	power		thermal protection rating (A)	dimensions			weight Kg
	kW	HP		A	B	P	
Q1 EL T	0.55÷3.7	0.75÷5.5	2÷8	340	240	170	2

Contact Customer Service for higher power electric control panels

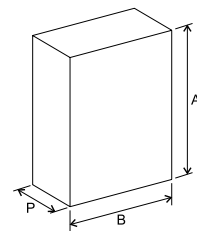

### Operating limits

Ambient temperature: -5/+40°C

50% relative humidity at 40°C (not condensed)

### Optional accessories

- 90 dB acoustic alarm - input command from float switch or pressure switch
- Flashing visual alarm - complete with input command terminals
- Acoustic alarm with buffer battery (involves box change)
- Kit of 3 level gauges for dry running protection
- 20 µF wired capacitor kit
- 30 µF wired capacitor kit
- 40 µF wired capacitor kit
- 50 µF wired capacitor kit
- 70 µF wired capacitor kit

# Q2EL T

## Electronic control panel for 2 three-phase pumps

### General characteristics



- Power supply 1~ 50/60Hz 400V +/- 10%
- Very low voltage input for command from 2 pressure switches or float switches
- Very low voltage input for command from pressure switch or level alarm float switch
- Very low voltage input for external command from 3 minimum level gauges
- Built-in pump alternation circuit with 4" startup delay
- Internal selector for pump alternation exclusion
- Selector for the operation of filling/draining sensors
- 2 selectors for operating the motors in "Automatic-Off-Manual"
- Green "Power On" LED
- 2 green "Automatic Operation" LEDs
- 2 green "motor running" LEDs
- Red "level alarm" LED
- 2 red "motor overload protection alarm" LEDs
- Time for protection activation: 5"
- Protection reset button
- Internal sensor sensitivity regulator
- Adjustable amperage protection for motor overload
- Motor protection fuses
- Auxiliary circuits protection fuse
- Alarm output with N.O.-C-N.C. changeover contacts (16A 250V resistive load capacity)
- Main switch with door lock
- Output with cable holder
- ABS housing
- IP55 protection rating

### Technical characteristics

	power		thermal protection rating (A)	dimensions			weight Kg
	kW	HP		A	B	P	
Q 2 EL T	0.55÷3.7	0.75÷5.5	2÷8	340	240	170	4.5

Contact Customer Service for higher power electric control panels

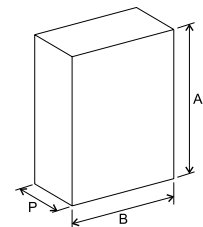

### Operating limits

Ambient temperature: -5/+40°C  
50% relative humidity at 40°C (not condensed)

### Optional accessories

- 90 dB acoustic alarm - input command from float switch or pressure switch
- Flashing visual alarm - complete with input command terminals
- Acoustic alarm with buffer battery (involves box change)
- Kit of 3 level gauges for dry running protection

# 5.2 ALARMS

The alarm devices provide acoustic and/or acoustic/visual signalling of plant malfunctions such as power blackouts, allowing swift corrective action.  
The internal buffer battery ensures lengthy autonomy.

## SA1 - SLA1

### Self-powered alarm panel

#### General characteristics



- Power supply 1~ 50/60Hz 230V +/- 10%
- Very low voltage input for alarm command from free contacts N.O. and N.C.
- Green "Power On" LED
- Red "level alarm" LED
- Red "acoustic alarm off" LED
- Alarm siren 90 dB at 1 mt.
- Red electronic flasher (only on model SLA1)
- Acoustic alarm ON/OFF buttons
- Alarm reset button
- Battery charger and buffer battery for 24 hour power supply
- Internal selector "continuous/self-resetting alarm"
- Internal selector for alarm-timer activation
- Acoustic alarm timer adjuster 0-180"
- ABS housing
- Output with cable holder
- IP55 protection rating

#### Technical characteristics

	duration of the batteries	acoustic pressure	dimensions			weight Kg
			A	B	P	
SA/1	24h	90 dBm	340	240	170	1
SLA/1	24h	90 dBm	410	240	170	1.5

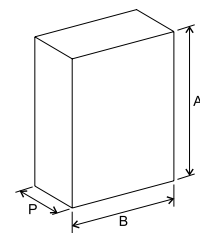

#### Operating limits

Ambient temperature: -5/+40°C  
50% relative humidity at 40°C (not condensed)



# 5.3 FLOAT SWITCHES

Specific for controlling electric pumps, even for installations with dense and soiled liquids.  
Models with explosion-proof certification also available.



## Technical characteristics

Current	Cable		
	Type	Wires	Length (m)
10A / 250V	H07RN-F	3G1	0.50
10A / 250V	H07RN-F	3G1	5
10A / 250V	H07RN-F	3G1	10

Used ONLY for draining

## Overall dimensions

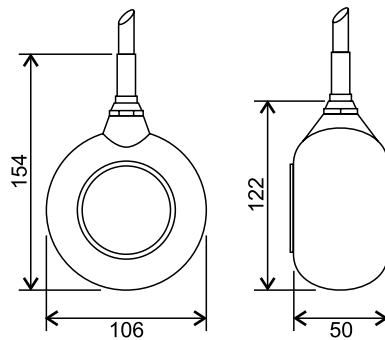

## Technical characteristics

Current	Cable		
	Type	Wires	Length (m)
5A / 250V	TPK	3G1	10
5A / 250V	TPK	3G1	20
5A / 250V	TPK	3x0.75	10



Suitable for draining and filling

## Overall dimensions

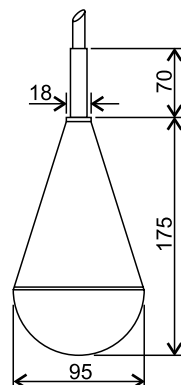

# 5.4 REMOTE CONTROL SYSTEMS

Nowadays, microprocessor remote control systems are an essential tool for the managing of water treatment plants.

There are many benefits to be had from the use of remote control systems, due mainly to the capability for receiving and sending data to and from remote positions in real time.

This allows the simultaneous management of several plants, with rapid intervention in response to malfunctions only, reducing the costs arising from scheduled servicing and inspections.

What's more, the uniform distribution of the workload across the various machines installed optimises wear of rotary components, reducing expenditures on parts and labour.

The saving of the key data for the pumps installed in a log file allows constant monitoring of their operating parameters and scheduling of servicing work to prevent inconvenient plant stoppages.

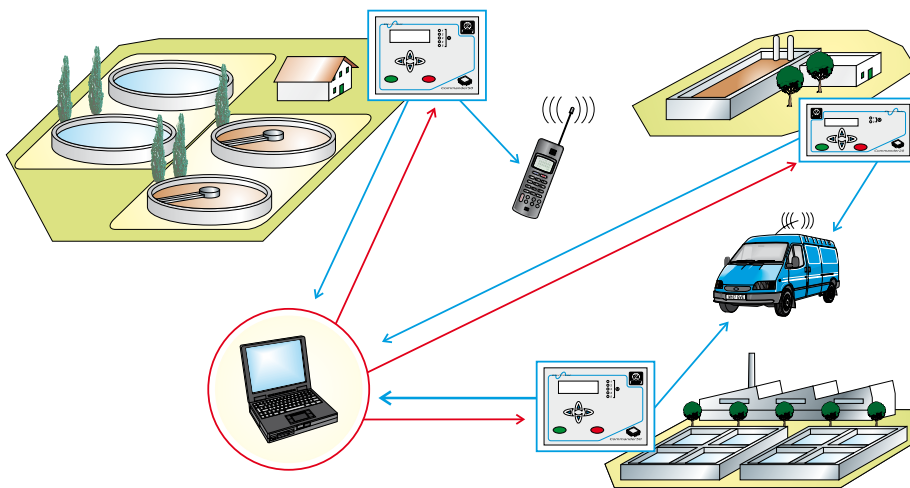

## Safety above all

The use of "intelligent" systems also generates an improvement in safety standards. The processing of alarms linked to operating parameters provides notification and allows immediate intervention in case of malfunctions such as, for example, surpassing of level thresholds, dry running and the accidental entry of water into the mechanical seal oil sump before these events can constitute a threat to normal operation of the plant. There is also a specific input for a tamper alarm, preventing unauthorised modification of the set parameters, ensuring completely safe operation.



# COMMANDER 20-50

## Remote control system

The COMMANDER is a microprocessor unit for integration in the electrical control panel, capable of managing plant operation.

COMMANDER is available in 2 versions: the COMMANDER 20 for control of up to 2 pumps and the COMMANDER 50, able to control up to 5 pumps.

Use is simplified by a menu which guides the user through the setting and selection of the various functions step by step. The user can use a liquid crystal display showing plant data and a keypad for setting the operating parameters.



The programmable functions for plant management are:

- Draining or filling, based on the signal from a sensor and on the start and stop thresholds
- Management of pumps in a group, alternating operation, based on the number of starts or the maximum continuous operating time
- Control of the maximum number of pumps in operation to prevent electrical overloading
- Activation of emergency pump set by the user which replaces another pump which is malfunctioning
- Startup delay between one pump and another to avoid peaks in power draw
- Extended operation to encourage the cleaning of the tank and the surface of the liquid
- Periodic startup in case of prolonged stops in order to prevent the blockage of the pump
- Pumps can be operated in continuous (S1) or intermittent (S3/S9) mode

The functions that can be activated for managing alarms and faults are:

- Reporting of pump malfunctions with shutdown in case of blocking fault (entry of water into the mechanical seal sump, entry of water into the motor compartment, tripping of thermal cut-out, overloading, lack of electrical power phase, lack of pump startup)
- Notification that the hours of operation/number of starts threshold has been reached for scheduled maintenance
- Reports from the auxiliary analogue and digital data acquisition channels (surpassing of the set limits for each input channel)
- Management of extreme minimum and extreme maximum float switches and thresholds in case of level gauge breakdown
- Reporting of power blackouts
- Magnetothermic cutout on the electrical control panel (OVERLOAD)
- Warning of control panel opening or intrusion into the plant
- Reporting of low emergency battery

COMMANDER stores the following historical data in its internal memory or on the PC:

- Total operating time per pump
- Number of starts per pump
- Data from the auxiliary channels
- Historical data regarding the alarms, divided by pump and type

COMMANDER manages the operation of the pumps in a completely safe manner and allows maintenance interventions to be optimized thanks to the constant monitoring of the plant's key data.



The COMMANDER unit can be connected to a piezocapacitive, piezoresistive or ultrasound level gauge.

For improved safety, COMMANDER also controls two emergency float switches located in the tank, corresponding to the extreme maximum level (beyond which there is the risk of overflowing) and the extreme minimum (below which the pumps run dry).

In the case of gauge fault, the emergency float switches guarantees plant operation and the COMMANDER unit reports the anomaly in real time as an acoustic-visual alarm, with notification on the remote computer through the SW COMMANDER and, if the optional GSM module is installed on the device, via text message to the mobile phone of the maintenance personnel.

COMMANDER can send all alarm messages by means of text messaging to a maximum of 3 different telephone numbers. The software also gives notification that the residual credit on the SIM card is finished.

The automatic system restart option ensures that the plant will continue operating after a possible black-out or distractions by the operators.

Conversely, a specific option stops the plant, avoiding the undesired starting of the pumps in case of maintenance interventions.

The COMMANDER unit has 4 analogue channels and 3 digital auxiliary inputs designed for the connection of sensors or transducers for the reading of measurable parameters of the fluids, such as:

- level measuring devices
- flowrate measuring devices
- pH meter
- oxygen measuring devices
- density measuring devices
- ammeters

### Technical characteristics

	Commander20	Commander50
2 line display	●	●
4 line display	●	●
Pump status indication on the front panel (on/off/alarm) with luminous LED	●	●
Possibility of selecting the menu language	●	●
Management of up to 2 pumps	●	●
Management of up to 5 pumps	●	●
Management of extreme maximum level	●	●
Management of extreme minimum level	●	●
Management of alternating startup and extended running	●	●
Emergency pump management	●	●
Alarm for the entry of water into the seal sump	●	●
Alarm for the entry of water into the motor compartment	●	●
Pump overheating alarm	●	●
No phase alarm	●	●
No power alarm	●	●
Alarm for the magnetothermic cutout in the electrical control panel (OVERLOAD)	●	●
Intrusion alarm	●	●
9 additional programmable ON/OFF relays that can be activated from the analogue inputs	●	●
2 additional programmable N.C./N.O. changeover relays	●	●
4 programmable analogue inputs with intervention thresholds	●	●
ON/OFF relay for command of the pumps	●	●
Acoustic/visual alarm management relay	●	●
Analogue input for the level gauge	●	●
Digital input for the generic pulse counter	●	●
Analogue output to replicate the signal from the sensor	●	●
LOCAL RS232 serial port output	●	●
HOST RS485 serial port output	●	●
GSM module and antenna with capacity of 3 stored numbers	●	●

- Standard
- Optional
- Not available

Overall dimensions

Commander20

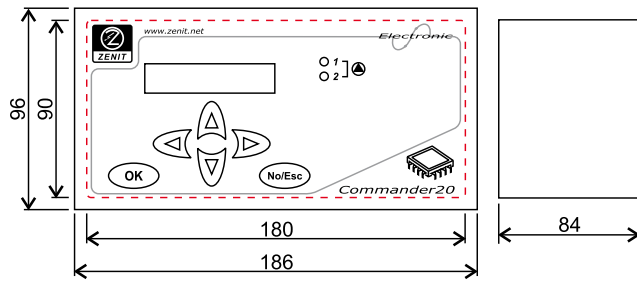

Commander50

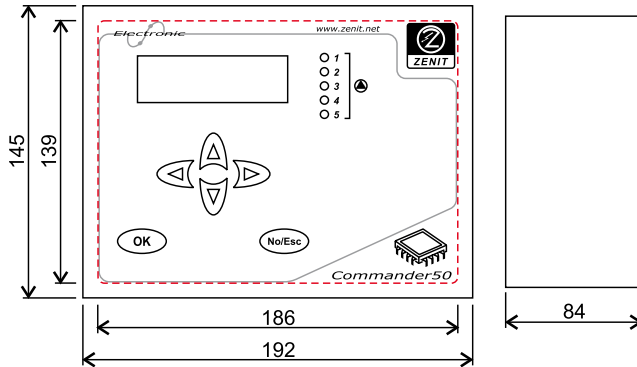

# COMMANDER SW

## Plant management software

SOFTWARE COMMANDER is the special programme which, once installed on your PC, displays and manages the plant's situation in real time and allows you to modify the operating parameters.

To consult the station's operating status from a distance, one or more COMMANDER units can be managed, graphically and numerically, by COMMANDER SW. This software can check the operating parameters and status of numerous units situated on the territory.

Communication between PC and COMMANDER units can be done by:

- local serial port cable RS232 (standard)
- RS485 interface cable (optional)
- GSM modem (optional in replacement of RS485)

