

LEWA intellidrive®

The mechatronic
All-in-One pump system

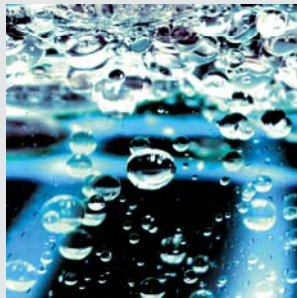

- intelligent
- flexible
- dynamic
- high precision

For diverse applications: LEWA intellidrive® – a limitless range of potential uses



Mixing two media in one pump head: LEWA intellidrive® with sapient drive.

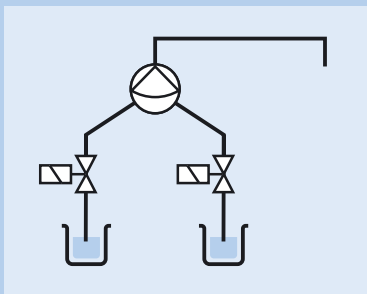

Precision filling: LEWA intellidrive® synchronizes with the filling machine, e.g. in the pharmaceutical industry.

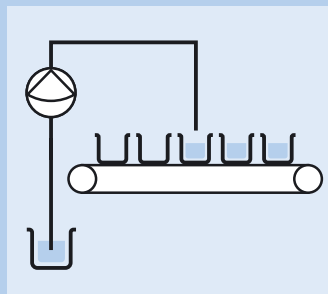
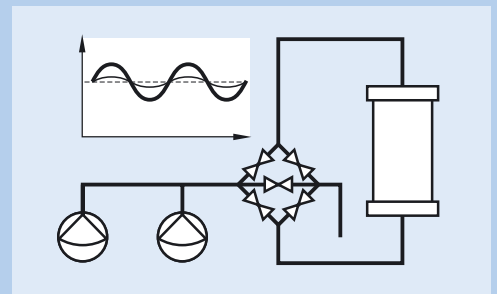

Photo: ratiopharm

By intelligently overlaying the feed flows of two single pumps, it is possible to prevent pressure pulsation, even without pulsation dampers.



LEWA engineering for your special application.

LEWA is uniting what was previously separate: Pumps with standard frequency-controlled drives and separate stroke adjustment actuator can now be combined into one unit. This simplifies the installation and wiring effort, since pre-wired plugs at the pump motor connect the supply and signal lines to the controller. As a new feature, a partial stroke mode handles stroke length adjustment for adjusting the volumetric feed rate. In this process, the pump piston does not fully travel to front dead center in the compression stroke phase –

the piston stops before this point depending on the desired volumetric flow rate and travels in reverse for the suction stroke. Operators in the pharmaceutical industry will especially welcome the new self-cooling, ventilator-free motors. The innovation of being able to alter the angular velocity during a revolution (i.e. within the compression and/or suction phases as well) not only allows stroke velocity to be modified variably; more importantly, it offers maximum flexibility and the ability to react to highly challenging engineering processes.

Naturally, there is field bus communication: Interfaces for Ethernet

and Profibus, for example, guarantee smooth system integration. Analog inputs and outputs – e.g. for valve control – are expandable.

LEWA intellidrive® is also available in a stand-alone variant with user interface and the necessary control intelligence compactly integrated in the drive unit. As an option, the system may also be integrated into a higher-level process control system.



Pumping high-viscosity fluids:
LEWA intellidrive® masters different suction
and compression stroke frequencies.

When feed volumes are variable:
Production with LEWA intellidrive® minimizes
downtimes, e.g. in extrusion technology.

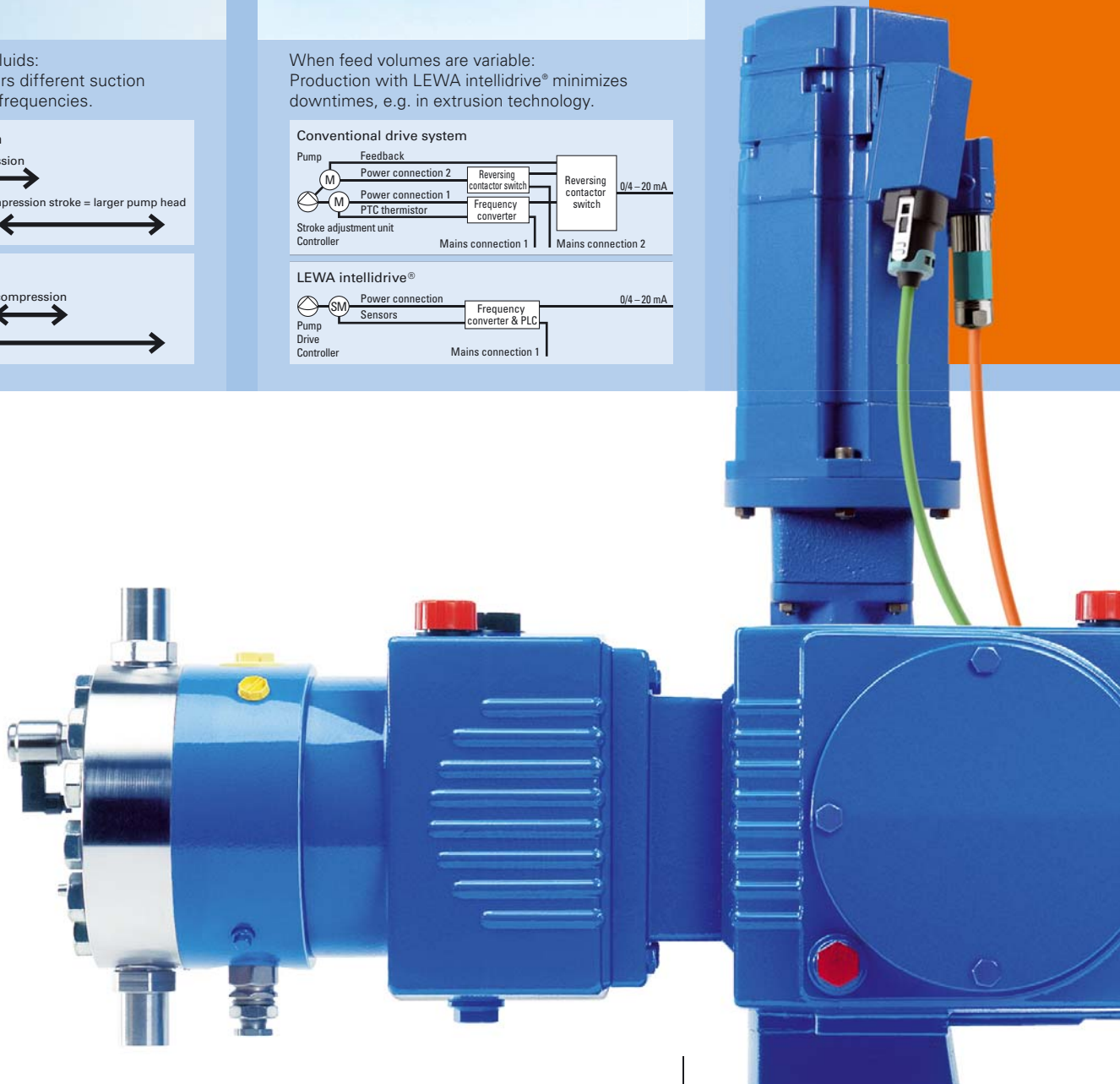
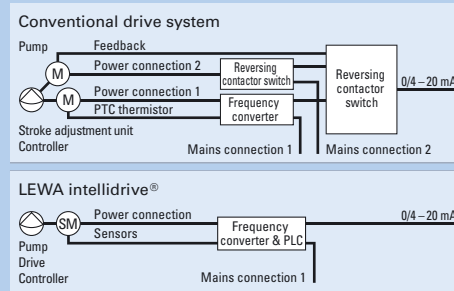
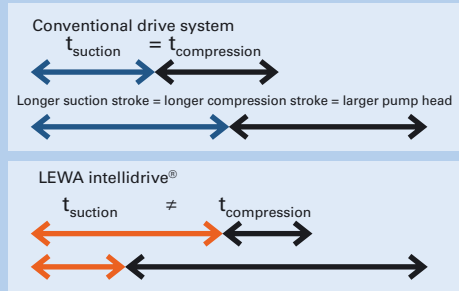

For specific requirements: LEWA intellidrive® – individually designed for you

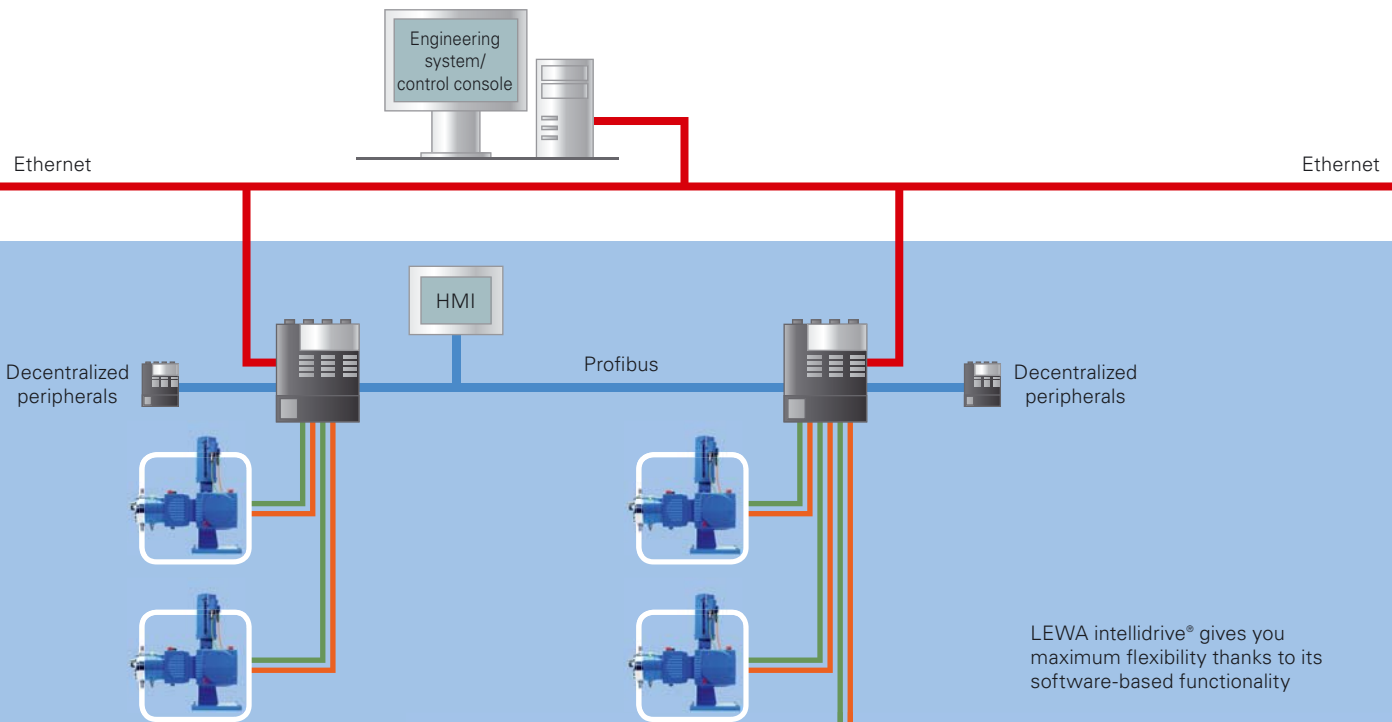

Standardized drive and automation hardware together with LEWA know-how that is built into the software to meet your individual requirements. The diagram illustrates an example of a configuration model.

HMI = Human-Machine Interface

LEWA intellidrive® combines practice-proven LEWA diaphragm pump technology and the latest advances in drive technology.

Closed-loop speed and position control with feedback of actual kinematic data (displacement-time data) for the electric drive make it possible to implement entirely new functions – offering more potential applications.

Example: High-resolution and precise piston positioning enables very precise feeding of defined material volumes for filling purposes.

Highly efficient compact motors reduce life-cycle costs considerably.

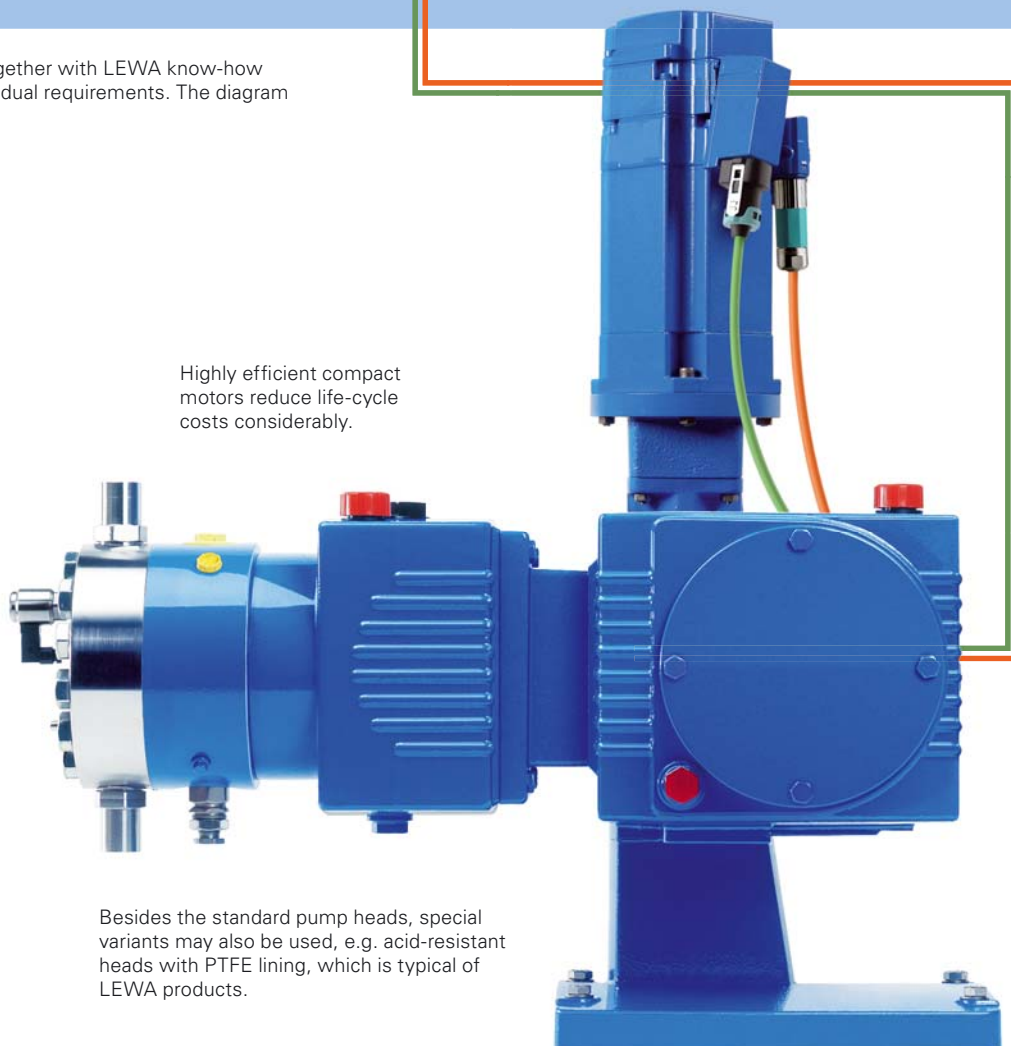

Besides the standard pump heads, special variants may also be used, e.g. acid-resistant heads with PTFE lining, which is typical of LEWA products.

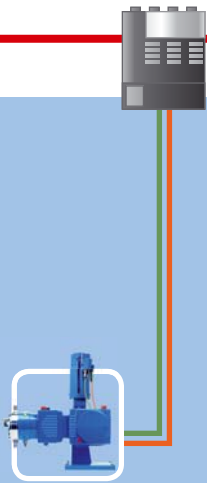

Use of single pump for simple control requirements, e.g. high-precision filling

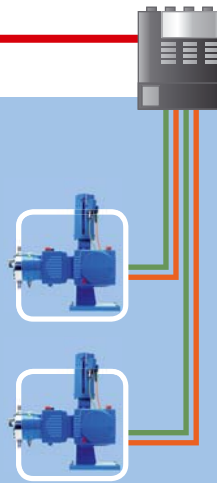

Dual-pump layout for virtually pulsation-free metering

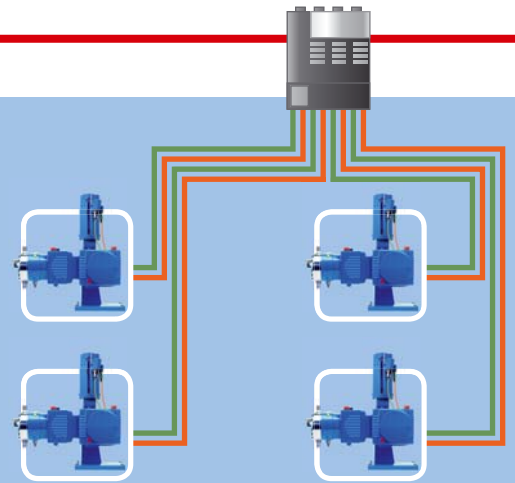

Synchronizable multi-pump layout

LEWA intellidrive® is able to adjust the drive-side angular velocity on the fly to adapt fluid kinematics to the specific requirements of your process.

The diagrams illustrate – in a direct comparison to standard drive systems – how LEWA intellidrive® reduces flow pulsation.

With a second pump in the system layout, it is possible to generate nearly pulsation-free volumetric flows by precise electronic synchronization of the mechanically decoupled pumps.

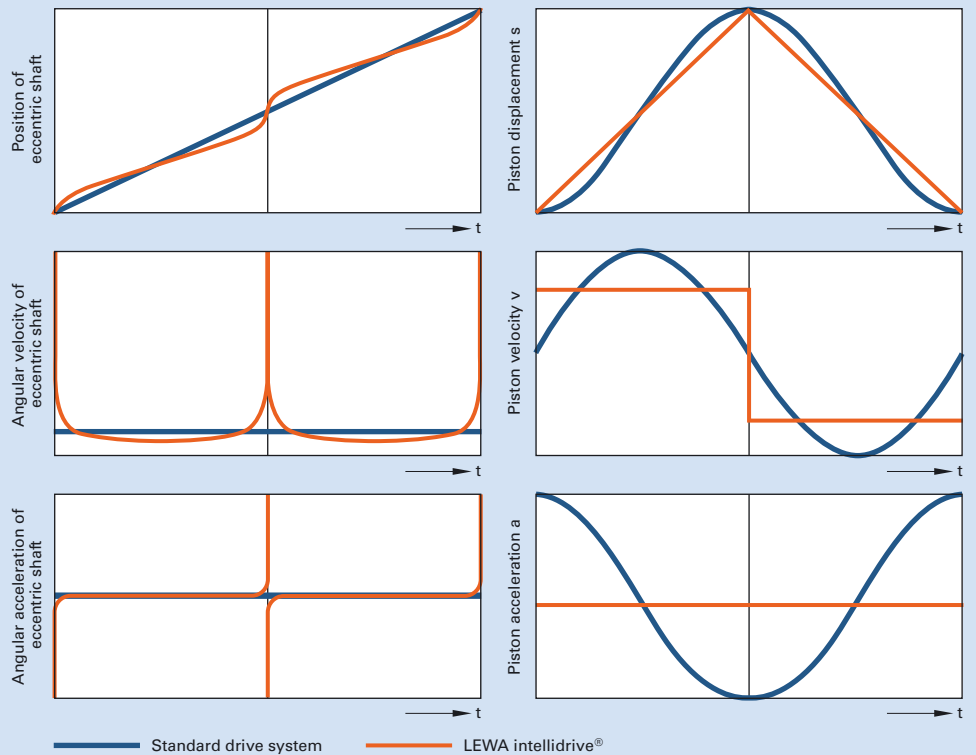

High-viscosity fluids can only be pumped by intelligent stroke travel control, especially during the suction phase. LEWA intellidrive® handles this.

- $b_k(t)$ = plunger acceleration
- $v_k(t)$ = plunger velocity
- $b_{s \max.}$ = maximum suction stroke acceleration
- $v_{s \max.}$ = maximum suction stroke velocity

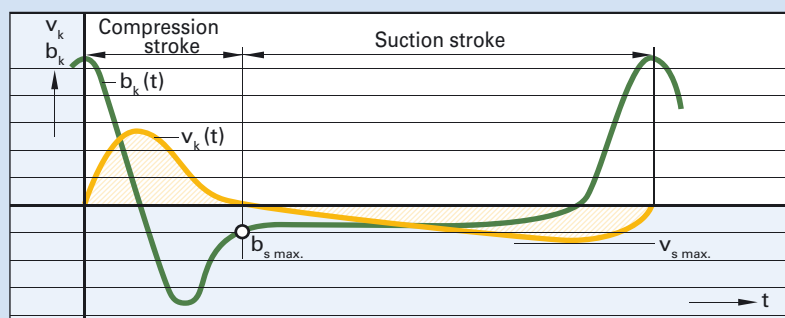

For widely diverse applications: Mechatronic systems in practice



Combining two media in one pump: No problem with LEWA intellidrive®.

Valves on the suction side of a pump head controlled by LEWA intellidrive® can transport two different fluids. This involves controlling the rotational angle to distribute the drive's suction stroke according to the desired volumetric ratio of the two media. The valve for Fluid 1 opens at front dead center, and this fluid is suctioned into the pump head. When a computed rotational angle is reached, the motor stops and the valves are switched over. Now the pump suction Fluid 2 into the pump head. At the rear dead point the valves close. The motor re-

starts, and then the pump pushes the fluid mixture out. The advantage: The mixing ratio can be adjusted by drive control, and the combined volumetric flow rate can be adjusted by rotational speed control.

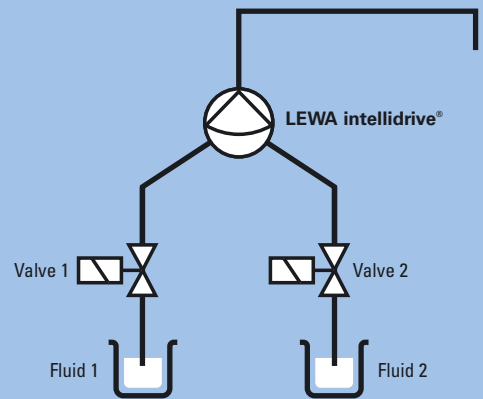

High-viscosity media: LEWA intellidrive® can handle different suction and compression stroke frequencies.

When transporting highly viscous media, high inlet pressure losses often occur during suction of the media into the pump's working chamber. In conventionally operated pumps, the time for suctioning a stroke volume is equal to the time for expelling it – but ideally the flow rate should be kept as small as possible during suction. Previ-

ously, this problem was addressed by designing pumps with large nominal sizes, i.e. large cross-sectional flow areas and therefore slower flow rates. These pumps are often oversized, since they were actually designed for pumping significantly larger material flows of normal viscosity. The solution: LEWA intellidrive® can handle different suction and compression stroke frequencies. The high viscosity fluid can be suctioned slowly with little pressure loss through

valves with smaller nominal inside diameters – and can then be quickly expelled in the process' compression stroke. Now high-viscosity fluids or fluids with high vapor pressure no longer require slow feed pumps with oversized heads. A slower (low-loss) suction stroke can be combined with a fast compression stroke to achieve time compensation. The pump head can then be kept as small as would be required to transport fluids similar to water.



Pumping high-viscosity fluids

Conventional drive system

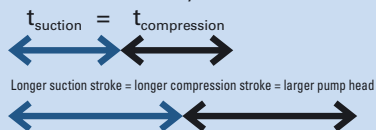

LEWA intellidrive®

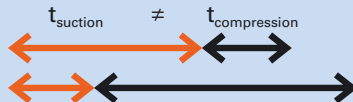

Suction stroke and compression stroke frequencies are different

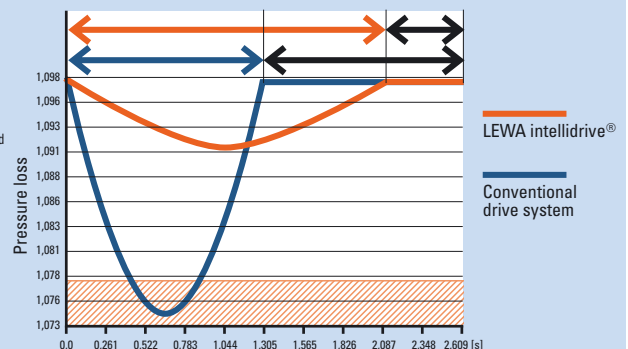

Chromatography: Precision in low-pressure and high-pressure separation.

In chromatographic systems, LEWA intellidrive® can play out all of its advantages simultaneously. For example, the combination “speed variation” and “partial stroke mode” yields a maximum adjustment range of over 1 : 100. While conventional technology requires frequency converters and an electric stroke adjuster, each of which must be supplied with separate power and data connections, LEWA intellidrive® just requires one connection. LEWA intellidrive® can even choose the optimal adjust-

ment mechanism. This enables gradient adjustment over almost any value and with high precision in transporting the eluent. This can be done in both low-pressure systems with the LEWA ecodos® hygienic program and in HPLC with ecoflow® hygienic series pumps. When intelligent control of two pumps is implemented, virtually pulsation-free operation is possible.

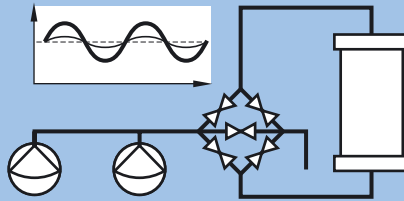

Photo: radiopharm

Cycle frequencies in harmony: LEWA intellidrive® synchronizes with the filling machine.

LEWA intellidrive® is perfectly suited for filling processes: The drive synchronizes itself with the cycle frequency of the filling machine. Starting at dead center, the system suctions the desired fill volume – defined by the rotational angle of the motor. The motor then stops and waits for a pulse from the filler. The pump then expels the fill charge by reversing

rotational direction. The duration of the suction stroke can be adjusted independently of the duration of the compression stroke. This means that special properties of the medium or

certain fill sequences can be taken into consideration. Because the system is hermetically sealed, it is especially well suited to sterile filling processes.

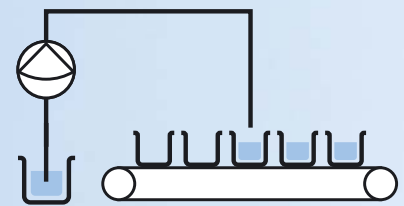
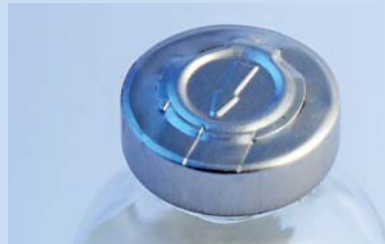

When process parameters change: LEWA intellidrive® takes control for you.

Do process parameters change frequently in your production process? Does material flow need to be adjusted quickly and over a broad adjustment range? Then LEWA intellidrive® can offer ideal performance.

For example, in foaming plastics the foaming agent must be uniformly reproducible and must be metered according to the size of the part being produced – that is decisive for product quality. Normally, these systems run with closed-loop control where the higher-level controller sets a control parameter. The metering unit has to quickly

compensate for possible changes in the production process due to fluctuations in pressure and temperature. Since components of various sizes are produced in such systems, a wide adjustment range is required, which is ideally adjustable from the minimum to maximum feed rate without waiting times. LEWA intellidrive® fulfills all of these requirements.

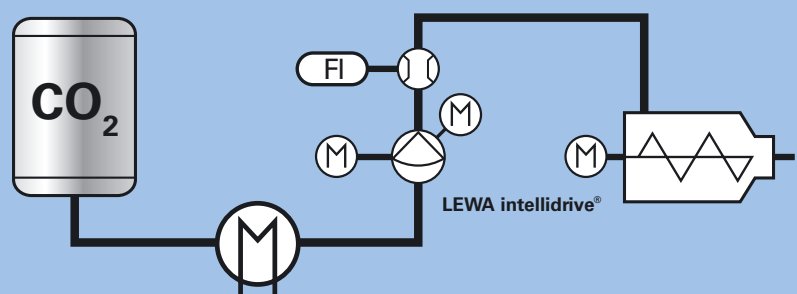

For short distances: LEWA at your service worldwide



Germany / Headquarters

■ **LEWA GmbH**

Ulmer Str. 10
71229 Leonberg
Phone +49 7152 14-0
Fax +49 7152 14-1303
lewa@lewa.de
www.lewa.de

■ **LEWA HOV GmbH + Co KG**

Neue Ramtelstr. 48
71229 Leonberg
Phone +49 7152 6091-0
Fax +49 7152 6091-59
hov@hov.de
www.hov.de

Austria

■ **LEWA Pumpen GmbH**

1150 Vienna
Phone +43 1 8773040-0
info@lewa.at
www.lewa.at

Brazil

■ **LEWA Bombas Ltda.**

04378-400 São Paulo - SP
Phone +55 11 56770466
info@lewa.com.br
www.lewa.com.br

Bulgaria

■ **LEWA – Technical Office Sofia**

1421 Sofia
Phone +359 2 8654088
lewa.bg@lewa.at
www.lewa.bg

China (P.R.C.)

■ **LEWA Pumps (Dalian) Co., Ltd.**

116600 Dalian
Phone +86 411 8758-1477
sales@lewa.cn
www.lewa.cn

Czech Republic

■ **LEWA Pumpen spol. s.r.o.**

602 00 Brno
Phone +420 5 43236052
office@lewa.cz
www.lewa.cz

France

■ **LEWA S.A.S.**

78500 Sartrouville
Phone +33 1 308674-80
info@pompes-lewa.fr
www.lewa.fr

Hungary

■ **LEWA Kft.**

1012 Budapest
Phone +36 1 2240403
info@lewa.hu
www.lewa.hu

Italy

■ **LEWA S.R.L.**

20017 Mazzo di Rho (Mi)
Phone +39 02 9346861
info@lewa.it
www.lewa.it

Mexico

■ **LEWA México – Technical office**

01210 México D.F.
Phone +52 55 91 72 92 10 280
info@lewa.es
www.lewa.es

Norway

■ **LEWA AS**

4319 Sandnes
Phone +47 52 9091-00
info@lewa.no
www.lewa.no

Poland

■ **LEWA Sp. z o.o.**

00-159 Warsaw
Phone +48 22 6358204
info@lewa.pl
www.lewa.pl

Romania

■ **LEWA Romania s.r.l.**

050579 Bucharest
Phone +40 21 4107340
info@lewa.ro
www.lewa.ro

Singapore

■ **LEWA PTE LTD**

Singapore 129808
Phone +65 686 17127
info@lewa.sg
www.lewa.sg

Singapore

■ **Pump Alliance PTE LTD**

Singapore 129808
Phone +65 646 86802
pbeddard@cpcasia.com.sg
www.pumpalliance.sg

Spain

■ **LEWA Hispania, S.L.**

08020 Barcelona
Phone +34 93 2247740
info@lewa.es
www.lewa.es

Switzerland

■ **LEWA Pumpen AG**

4153 Reinach 1
Phone +41 61 7179400
info@lewa-pumpen.ch
www.lewa-pumpen.ch

UAE / Dubai

■ **LEWA GmbH (LEWA Branch)**

Dubai Airport Free Zone, UAE
Phone +971 4 2993969
lewa@lewa-dubai.ae
www.lewa.ae

Ukraine

■ **LEWA Ukraine LC**

03039 Kiev
Phone +380 44 52796-31
lewa.ua@lewa.at
www.lewa.at

USA / North- and Middle America

■ **LEWA, Inc.**

Holliston, MA 01746
Phone +1 508 429-7403
sales@lewa-inc.com
www.lewa-inc.com

USA / Gulf Coast Oil & Gas Production

■ **Capital Process Management, Inc.**

Houston, TX 77086
Phone +1 713 673-5161
rfletcher@capitalprocess.com
www.capitalprocess.com

Find more LEWA subsidiaries
at www.lewa.com