

VERDERFLEX®

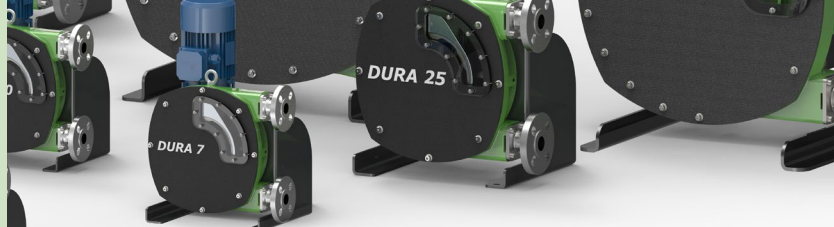

Peristaltic Industrial Hose Pump

Operating Manual

Dura 5, 7, 10, 15, 25, 35

Version 5.1v-02/2015

Print-No. 01

motralec

4 rue Lavoisier . ZA Lavoisier . 95223 HERBLAY CEDEX
Tel. : 01.39.97.65.10 / Fax. : 01.39.97.68.48
Demande de prix / e-mail : service-commercial@motralec.com
www.motralec.com



VERDER

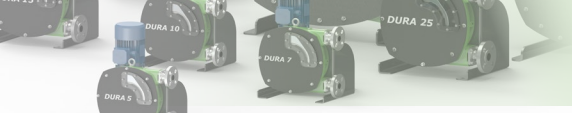

Version 5.1v-02/2015
Print-No. 01

Dura 5, 7, 10, 15, 25, 35



The information in this document is essential for the safe operation and servicing of Verderflex® Dura pumps. This document must be read and understood thoroughly prior to installation of unit, electrical connection and commissioning.

Table of contents

<p>1. About this document</p> <p>1.1 Target groups</p> <p>1.2 Warnings and symbols</p> <p>2. Safety</p> <p>2.1 Intended use</p> <p>2.2 General safety instructions</p> <p>2.2.1 Product safety</p> <p>2.2.2 Obligation of the operating company</p> <p>2.2.3 Obligation of personnel</p> <p>2.3 Specific hazards</p> <p>2.3.1 Hazardous pumped liquids</p> <p>2.3.2 Lubricants</p> <p>2.3.3 Sharp edges</p> <p>3. Layout and function</p> <p>3.1 Design details</p> <p>3.2 Labelling</p> <p>3.2.1 Name Plate</p> <p>3.3 Layout</p> <p>3.4 Bearings and Lubrication</p> <p>4. Transport, storage and disposal</p> <p>4.1 Transport</p> <p>4.1.1 Unpacking and inspection on delivery</p> <p>4.1.2 Lifting</p> <p>4.2 Treatment for storage</p> <p>4.3 Interim storage before installation</p> <p>4.4 Disposal</p> <p>5. Installation and connection</p> <p>5.1 Preparing for installation</p> <p>5.1.1 Checking the ambient conditions</p> <p>5.1.2 Preparing the installation site</p> <p>5.1.3 Preparing the foundation and surface</p> <p>5.2 Installation at site</p> <p>5.3 Planning the pipes</p> <p>5.3.1 Specifying supports and flange connections</p> <p>5.3.2 Specifying nominal diameters</p> <p>5.3.3 Specifying pipe lengths</p> <p>5.3.4 Optimizing cross-section of pipe work</p> <p>5.3.5 Providing safety and control devices (recommended)</p> <p>5.4 Assembling the pump</p> <p>5.4.1 Assembling pump case</p> <p>5.4.2 Installing the drive shaft</p> <p>5.4.3 Installing the rotor</p> <p>5.4.4 Assembling the front cover</p> <p>5.4.5 Assembling Gear motor unit</p> <p>5.5 Electrical connection</p> <p>5.5.1 Connecting to power supply</p> <p>5.6 Installing the Hose</p> <p>5.6.1 Inserting the hose</p> <p>5.6.2 Fitting the port flange (Standard assembly D15 - D35)</p> <p>5.6.3 Fitting the port flange (Standard Dura 5,7,10 assembly)</p> <p>5.6.4 Fitting the port flange (D15 - D35 Split flange assembly)</p> <p>5.6.5 Fitting the port flange (D05 - D10 Split flange assembly)</p> <p>5.7 Connecting the pipes</p> <p>5.7.1 Installing the piping</p>	<p>6. Operation</p> <p>6.1 Pre-commissioning the pump</p> <p>6.1.1 Checking the direction of rotation with dry pump</p> <p>6.1.2 Starting the pump</p> <p>6.1.3 Switching off</p> <p>6.2 Operation</p> <p>6.2.1 Switching on</p> <p>6.2.2 Switching off (Refer to -> 6.1.3)</p> <p>6.3 Shutting down the pump</p> <p>6.4 Start-up following a shutdown period</p> <p>6.5 Operating the stand-by pump</p> <p>7. Maintenance</p> <p>7.1 Inspections</p> <p>7.2 Maintenance</p> <p>7.2.1 Cleaning the pump</p> <p>7.2.2 Maintenance schedule</p> <p>7.3 Repairs</p> <p>7.3.1 Preparations for dismounting</p> <p>7.3.2 Returning the pump to the manufacturer</p> <p>7.3.3 Rebuild / Repair</p> <p>7.4 Hose change</p> <p>7.4.1 Dismounting the hose</p> <p>7.4.2 Re-installing the hose, port flanges, lubricant refill and fitting the inspection window</p> <p>7.5 Ordering spare parts</p> <p>8. Storing pumps and hoses</p> <p>8.1.1 Pre-Storage Actions</p> <p>8.1.2 Cleaning Protocol for hoses</p> <p>8.1.3 Storage Conditions</p> <p>9. Troubleshooting</p> <p>9.1 Pump malfunctions</p> <p>10. Appendix</p> <p>10.1 Technical Specifications</p> <p>10.1.1 Pump Specifications</p> <p>10.1.2 Ambient conditions</p> <p>10.1.3 Tightening torques</p> <p>10.1.4 Preservatives</p> <p>10.1.5 Cleaning agents (After hose is removed)</p> <p>10.1.6 Lubricants</p> <p>10.1.7 Rotor options</p> <p>10.2 List of Figures and Tables</p> <p>10.2.1 List of figures</p> <p>10.2.2 List of tables</p> <p>10.3 Declaration of conformity according to EC Machine Directive</p>
---	--

1. About this document



Verderflex range of Peristaltic pumps, Dura 5 - 35, has been developed according to the latest technology and subject to continuous quality control. These operating instructions are intended to facilitate familiarization with the pump and its designated use. The relevant information will act as a guideline for you in operating the pump; alternative courses of action are also described should you be unable, for any reason, to follow those procedures initially given. You are advised to follow these guidelines to achieve maximum efficiency. These operating instructions do not take into account local regulations; the operator must ensure that such regulations are strictly observed by all, including the personnel called in for installation.

1.1 Target groups



Target groups	Duty
Operating company	<ul style="list-style-type: none"> ▶ Keep this manual available at the operation site of the equipment, also available for later reference. ▶ Ensure that personnel read and follow the instructions in this manual and the other applicable documents, especially all safety instructions and warnings. ▶ Observe any additional rules and regulations referring to the system.
Qualified personnel, fitter	<ul style="list-style-type: none"> ▶ Read, observe and follow this manual and the other applicable documents, especially all safety instructions and warnings.

Tab. 1 Target groups and their duties

1.2 Warnings and symbols

Warning	Risk Level	Consequences of disregard
 DANGER	Immediate acute risk	Death, serious bodily harm
 WARNING	Potential acute risk	Death, serious bodily harm
 CAUTION	Potential hazardous situation	Minor bodily harm
NOTE	Potential hazardous situation	Material damage

Tab. 2 Warnings and consequences of disregarding them

Symbol	Meaning
	Safety warning sign in accordance with DIN 4844 - W9 <ul style="list-style-type: none"> ▶ Take note of all information highlighted by the safety warning sign and follow the instructions to avoid injury or death.
▶	Instruction
1., 2.,	Multiple-step instructions
√	Precondition
→	Cross-reference
	Information, recommendation

Tab. 3 Symbols and their meaning

2. Safety



The manufacturer does not accept any liability for damage resulting from disregard of this documentation.

2.1 Intended use

- Only use the pump to handle compatible fluids as recommended by the manufacturer (→ 10.1 Technical specifications).
- Adhere to the operating limits.
- Consult the manufacturer regarding any other use of the pump.
- Pumps delivered without a motor must be fitted with a motor in accordance with the provisions of EC Machine Directive 2006/42/EC.

Prevention of obvious misuse (examples)

- Note the operating limits of the pump with regard to temperature, pressure, flow rate and motor speed (→ 10.1 Technical specifications).
- Do not operate the pump while the inlet/outlet valve is closed.
- Only install the pump as recommended in this manual. For example, the following are not allowed:
 - Installing the pump without proper support.
 - Installation in the immediate vicinity of extreme hot or cold sources.

2.2 General safety instructions



Observe the following regulations before carrying out any work.

2.2.1 Product safety

These operating instructions contain fundamental information which must be complied with during installation, operation and maintenance. Therefore this operating manual must be read and understood both by the installing personnel and the responsible trained personnel / operators prior to installation and commissioning, and it must always be kept easily accessible within the operating premises of the machine.

Not only must the general safety instructions laid down in this chapter on “Safety” be complied with, but also the safety instructions outlined under specific headings.

- Operate the pump only if the pumping unit and all associated systems are in good functional condition.

- Only use the pumping system as intended, fully aware of safety and risk factors involved, and in adherence to the instructions in this manual.
- Keep this manual and all other applicable documents complete, legible and accessible to personnel at all times.
- Refrain from any procedure or action that would pose a risk to personnel or third parties.
- In the event of any safety-relevant faults, shut down the pump immediately and have the malfunction corrected by qualified personnel.
- The installation of the pump, associated pipe work and electrical fittings must comply with the requirements of installation given in this manual and any local national or regional health and safety regulations.

2.2.2 Obligation of the operating company

Safety-conscious operation

- Ensure that the following safety aspects are observed and monitored:
 - Adherence to intended use
 - Statutory or other safety and accident-prevention regulations
 - Safety regulations governing the handling of hazardous substances if applicable
 - Applicable standards and guidelines in the country where the pump is operated
- Make personal protective equipment available pertinent to operation of the pump; as required.

Qualified personnel

- Ensure that all personnel tasked with work on the pump have read and understood this manual and all other applicable documents, including the safety, maintenance and repair information, prior to use or installation of the pump.
- Organize responsibilities, areas of competence and the supervision of personnel.
- Have all work carried out by specialist technicians only.
- Ensure that trainee personnel are under the supervision of specialist technicians, at all times, when working on the pumping system.

Safety equipment

- Provide the following safety equipment and verify its functionality:
 - For hot, cold and moving parts: safety guarding should be provided by the operating company.
 - For potential build up of electrostatic charge: ensure appropriate grounding if and when required.

Warranty



The warranty is voided if the customer fails to follow any and all instructions, warnings and cautions in this document. Verder has made every effort to illustrate and describe the product(s) in this document. Such illustrations and descriptions are, however, for the sole purpose of identification and Do not express or imply a warranty that the products are merchantable or fit for a particular purpose, or that the products will necessarily conform to the illustration or descriptions.

Obtain the manufacturer's approval prior to carrying out any modifications, repairs or alterations during the warranty period. Only use genuine parts or parts that have been approved by the manufacturer.

For further details regarding warranty, please refer terms and conditions.

2.2.3 Obligation of personnel



It is imperative that the instructions contained in this manual are complied with by the operating personnel at all times.

Pump and associated components:

- Do not lean or step on them or use as climbing aid
- Do not use them to support boards, ramps or beams

- Do not use them as a fixing point for winches or supports
- Do not de-ice using gas burners or similar tools
- Do not remove the safety guarding for hot, cold or moving parts during operation.

Reinstall the safety equipment on the pump as required by regulations after any repair / maintenance work on the pump.

2.3 Specific hazards

2.3.1 Hazardous pumped liquids

Follow the statutory safety regulations when handling hazardous pumped liquids (e.g. hot, flammable, poisonous or potentially harmful). Use appropriate personal protective equipment when carrying out any work on the pump.

2.3.2 Lubricants

Ensure that the lubricant and pumped liquid are compatible with each other. This is a precautionary measure in case of accidental hose burst whereby the pumped liquid comes in contact with the lubricant.

(Refer datasheet for lubricant to ensure compatibility)

2.3.3 Sharp edges

Pump parts, such as the shims, can be sharp

- Use protective gloves when carrying out any work on the pump

3. Layout and function

i Peristaltic hose pump, Verderflex Dura, is simple by design in its construction and operation. The medium to be pumped does not come into contact with any moving parts and is totally contained within a robust, heavy-duty hose, which consists of an inner layer, two – six reinforcement layers and an outer layer. A rotor passes along the length of the hose, compressing it. This motion forces the contents of the hose directly in front of the rotor to move forward along the length of the hose in a ‘positive displacement’, peristaltic movement. In the wake of the rotor’s compressing action, the natural elasticity of the polymer reinforced rubber forces the hose to open and regain its round profile, creating suction pressure, which recharges the pump.

3.1 Design details

i Verderflex Dura is a twin lobe, single rotor, peristaltic pump with quick-fit tapered port flange design which clamps and seals in one easy movement to speed hose replacement.

3.2 Labelling

3.2.1 Name Plate

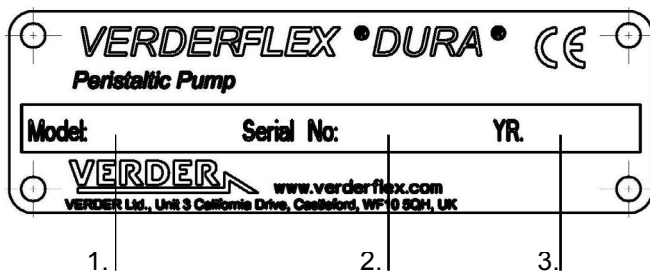

Figure 1: Name plate
 1. Pump type
 2. Serial number
 3. Year of manufacture

Note: *When requesting spares, the model and serial number should always be quoted.*

3.3 Layout

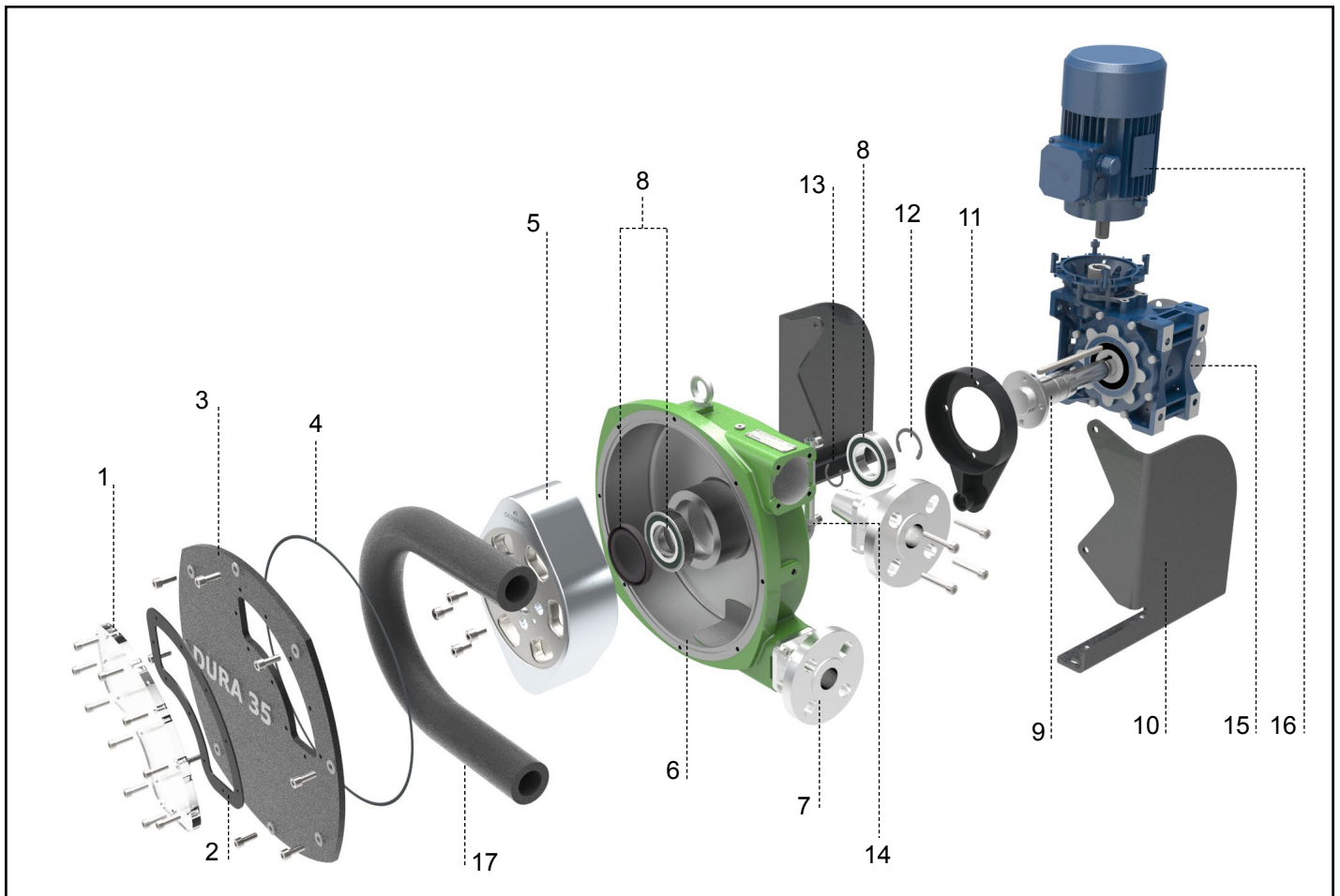

Figure 2 Layout (generic view)

- | | | | | | |
|---|--------------------------|----|-----------------------|----|-----------------------|
| 1 | Inspection window | 7 | Port flange | 13 | Crescent clip (small) |
| 2 | Inspection window gasket | 8 | Shaft mounting kit | 14 | Filler tube |
| 3 | Front cover | 9 | Drive shaft | 15 | Gearbox |
| 4 | O-ring | 10 | Frames | 16 | Motor |
| 5 | Rotor | 11 | Torque arm | 17 | Hose |
| 6 | Pump casing | 12 | Crescent clip (large) | | |

3.4 Bearings and Lubrication

- ▶ Pump: To be filled at installation with appropriate lubricant if not supplied pre filled. (→10.1.6 Lubricants)
- ▶ Bearings are sealed units and need no additional lubricant.

4. Transport, storage and disposal

4.1 Transport

 Always transport the unit in an upright position and ensure that the unit is securely attached to the pallet.

4.1.1 Unpacking and inspection on delivery

1. Unpack the pump/pump unit upon delivery and inspect it for transport damage.
2. Report any transport damage to the manufacturer/distributor immediately.
3. Retain the pallet if any further transport is required.
4. Dispose all packaging material according to local regulations.

4.1.2 Lifting

 **DANGER**

Death or crushing of limbs can be caused by falling loads!

1. Use lifting gear appropriate for the total weight to be transported.
2. Fasten the lifting gear to the lifting eye as shown in the following illustration.
3. Do not stand under suspended loads.



Figure 3 Fastening lifting gear to pump unit

4.2 Treatment for storage

 Unpainted steel surfaces should be coated with rust inhibitor and the unit should be stored in a dry, dust free environment not exceeding 60°C

NOTE

Material damage due to inappropriate treatment for storage!

- ▶ Treat all internal and external bare metal pump parts for storage.
- ▶ Renew treatment if necessary.

4.3 Interim storage before installation

NOTE

Material damage due to inappropriate storage!

Treat the pump with preservatives compatible with pumped media (precaution in case of spillage).

1. Close all openings with blanks, plugs or plastic covers.
2. Make sure the storage room meets the following conditions:
 - Dry, humidity not to exceed 80%
 - Out of direct sunlight
 - Frost-free; temperature range 0 to 40°C
 - Vibration-free; minimize
 - Dust-free; minimize

**Storage information for pumps withdrawn from use is listed in section 8, Storing pumps and hoses.*

4.4 Disposal



With prolonged use, pump parts can get contaminated by poisonous or radioactive pumped liquids to such an extent that cleaning may be insufficient.



WARNING

Risk of poisoning and environmental damage by the pumped liquid or oil!

- ▶ Use suitable personal protective equipment when carrying out any work on the pump.
- ▶ Prior to disposal of the pump:
 - Drain and dispose of the lubricant in accordance with local regulations.
 - Collect and dispose of any leaking pumped liquid or oil in accordance with local regulations.
 - Neutralize residues of pumped liquid in the pump.
- ▶ Dispose of the pump unit and associated parts in accordance with statutory regulations.

5. Installation and connection

NOTE

Material damage due to unauthorized modification on pump unit!

- ▶ Do not make any structural modifications to the pump unit or pump casing
- ▶ Do not carry out any welding work on the pump unit or pump casing

NOTE

Material damage caused by ingress!

- Do not remove any protective flange covers until immediately before connecting the pipes to the pump

5.1 Preparing for installation

5.1.1 Checking the ambient conditions

1. Make sure that the operating conditions are complied with (→ 10.1.1 Pump specifications)
2. Make sure the required ambient conditions are fulfilled (→ 10.1.2 Ambient conditions)

5.1.2 Preparing the installation site

- ▶ Ensure the installation site meets the following conditions:
 - Pump is freely accessible from all sides
 - Sufficient space is available for the installation/removal of the pipes and for maintenance and repair work, especially for the removal and installation of the hose.

5.1.3 Preparing the foundation and surface

- ▶ Make sure the foundation and surface meet the following conditions:
 - Level
 - Clean (no oil, dust or other impurities)
 - Capable of bearing the weight of the pump unit and all operating forces
 - Ensure the pump is stable and cannot tip over
 - Concrete foundation: Standard concrete strong enough to support the pump unit under load.

5.2 Installation at site

1. Lift the pump unit (→ 4.1.2 Transport)
2. Put the pump unit down at the installation site.
3. Bolt the pump down; use all 4 holes.

5.3 Planning the pipes

5.3.1 Specifying supports and flange connections

- When planning pipe runs take every possible operating condition into account:
 - Cold/warm medium
 - Empty/full
 - Unpressurized/pressurized
 - Positional change of the flanges
- Ensure that the pipe supports are designed to accommodate any movement from environmental or pressure imposed forces.

5.3.2 Specifying nominal diameters



Keep the flow resistance in the pipes as low as possible. Pipe work immediately connected to both inlet and outlet port of the pump should be straight runs for at least 1 meter.

Ensure that nominal pipe diameter is at least 1.5 times nominal pump-hose diameter to reduce pulsation.

5.3.3 Specifying pipe lengths

- Keep pipe work as short and direct as possible.
- To allow easy access when changing hoses, include a short, removable section adjacent to the port flanges.

5.3.4 Optimizing cross-section of pipe work

- Avoid bending radii of less than $10r$ (r - the radii of nominal piping)
- Avoid abrupt changes of cross-section along the piping.

5.3.5 Providing safety and control devices (recommended)

Making provisions for isolating and shutting off pipes



For maintenance and repair work.

- ▶ Provide shut-off valves in the suction and discharge lines.

Allowing safe removal of product

- ▶ Include drainage taps in suction and discharge lines at the lowest point.

Do's	Don'ts
<p>1. Short pipe run to suction side</p> 	<p>Long pipe run to suction side</p> 
<p>2. Reduced Joints/Bends</p> 	<p>Multiple Joints/Bends</p> 
<p>3. Connecting pipe with diameter 1.5 times pump hose diameter</p> <p>Pipe ID 1.5 times hose ID</p> 	<p>Connecting pipe with smaller than pump hose diameter</p> <p>Pipe ID < pump hose ID</p> 
<p>4. Pulsation damper connected close to the pump</p> <p>Pulsation Damper</p>  <p>Bellows</p>	<p>Pulsation damper connected away from pump</p> <p>10% loss in damper efficiency for every meter</p> 

Table 4 Do's and Don'ts

5.4 Assembling the pump

5.4.1 Assembling pump case

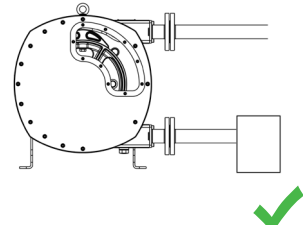
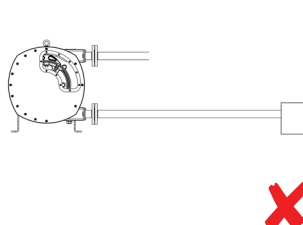
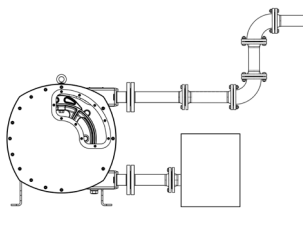
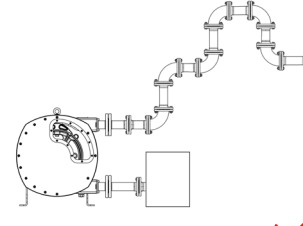
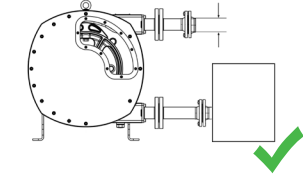
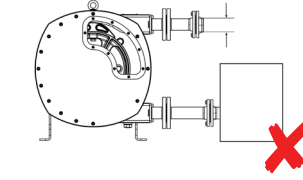
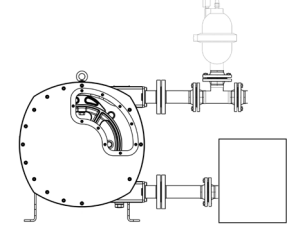
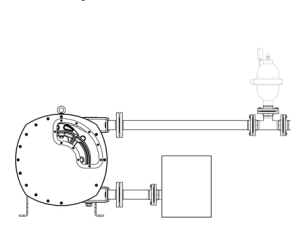

Using a bearing press, press the bearings squarely into the front and rear of the pump body until they locate on the shoulders in the pump housing.

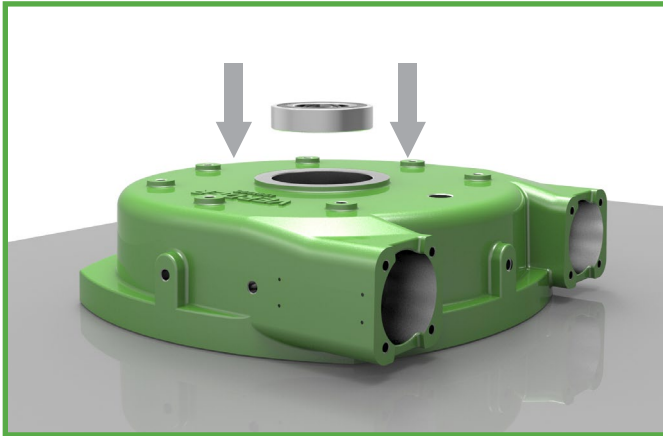

Figure 4 Inserting shaft seal

1. The shaft seal should be pressed squarely on top of the inner bearing with the sprung lip facing into the pump cavity.
2. Screw in the case blanking plugs.
3. Fit the lifting eye to the case.
4. It is also important at this point to attach the filler tube to the back of the pump as it could be difficult to attach once the Geared Motor Unit (GMU) is in place. Line the thread of the breather tube with PTFE tape and tighten into position to give a leak free seal.

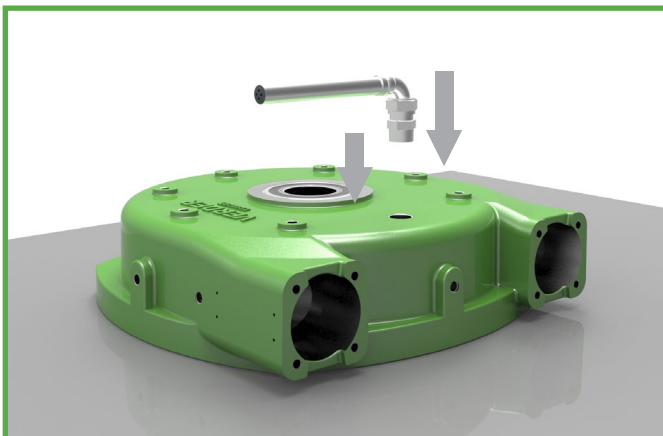

Figure 5 Fitting the filler tube

5. Mount the framework to pump housing using four of the cap head bolts and torque-tighten (Refer Table 11 for torque figures)

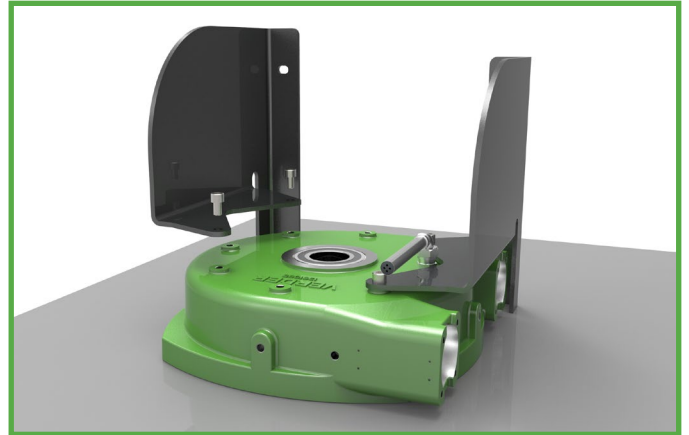

Figure 6 Fitting the frames

5.4.2 Installing the drive shaft

1. Apply some triple life bearing grease (Roccol Sapphire 2) to the drive shaft before assembly.

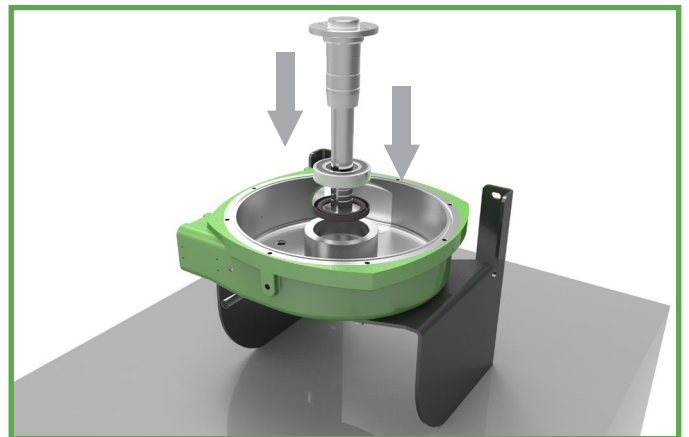

Figure 7 Applying lubricant on the drive shaft

2. Gently press the drive shaft through the bearing assembly.

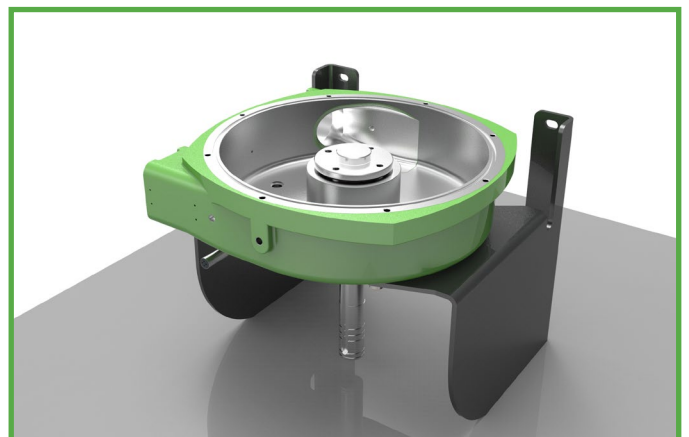

Figure 8 Installing the drive shaft



Figure 9 Inserting the crescent ring

- Once the drive shaft is in place the crescent ring groove should become visible at the rear of the pump. It is recommended to lock the drive shaft in place with the crescent ring before bolting the rotor in place.

5.4.3 Installing the rotor



Secure the rotor to the drive shaft using cap head screws. Failure to use all of the screws could compromise the performance of the pump.

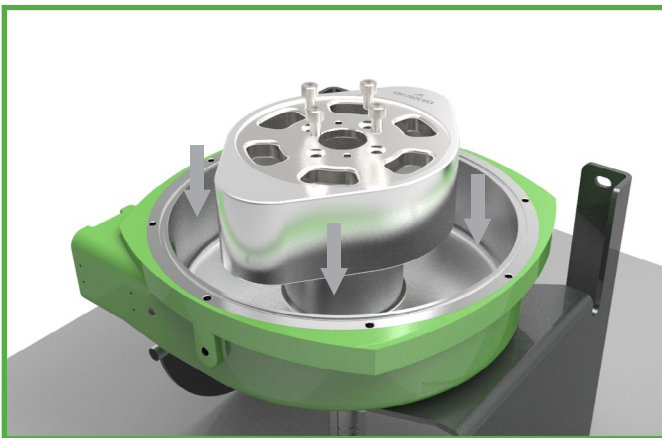

Figure 10 Fitting the filler tube

5.4.4 Assembling the front cover



The O-ring should sit securely in the groove located around the front of the pump housing. A small amount of grease may be required to hold the O-ring in place. The front cover should bolt in place with the use of cap head screws and washers.

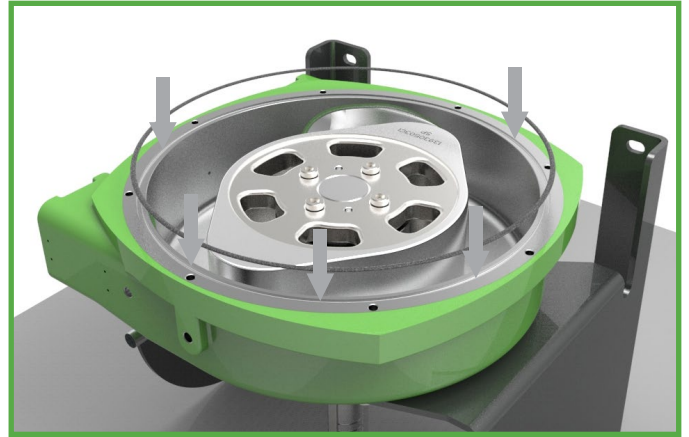

Figure 11 Inserting the O-ring (front cover assembly)

- When fitting the front cover, the cap head screw nearest to the inspection window, is fitted without a washer (Figure 12 Installing the front cover).

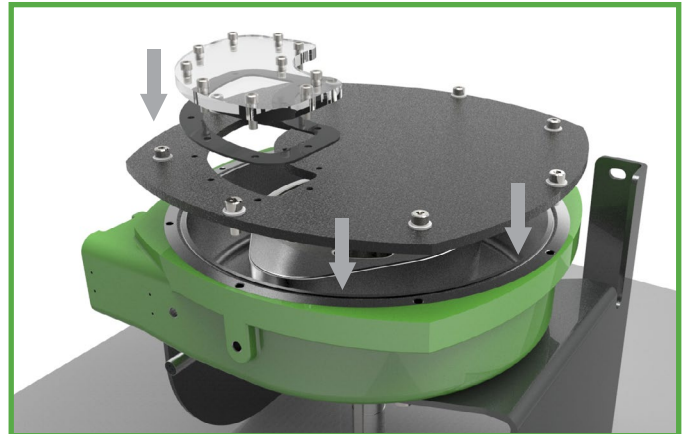

Figure 12 Installing the front cover

- Fit rest of the cap head screws with washers and torque-tighten (Refer table 11 tightening torques)
- Fit the inspection window gasket to the front cover.

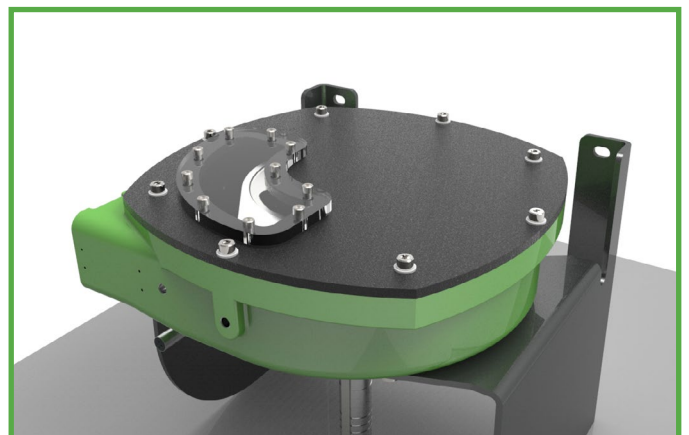

Figure 13 Placing the inspection window gasket

- Secure the inspection window to the front cover with cap head screws. Care must be taken not to overtighten the screws, as this may damage the inspection window (Refer table 11 Tightening torques).

5.4.5 Assembling Gear motor unit

- Press fit the torque arm bush into the torque arm; then fasten the torque arm to the GMU with the shaft sleeve facing away from the gearbox before attempting to fit it onto the drive shaft.

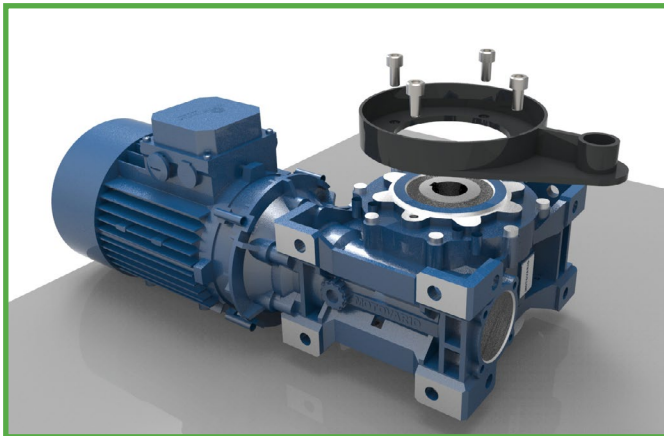

Figure 14 Fitting the torque arm

- Grease the shaft before fitting the GMU.
- Align the drive shaft key and GMU keyway; then slide the GMU over the drive shaft.

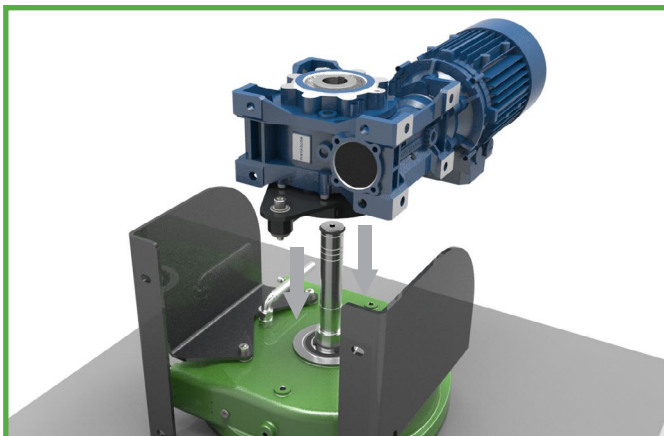

Figure 15 Aligning the drive shaft

- Fasten the torque arm to the housing and complete the installation of the GMU (Refer table 11 tightening torque).

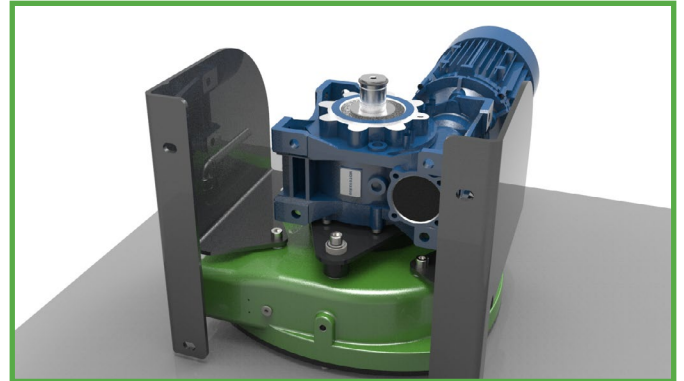

Figure 16 Fastening the torque arm

- Use the crescent clip supplied to stop the GMU from sliding off the end of the shaft. Variations may be secured using bolt and washer.

5.5 Electrical connection

⚠ DANGER

Risk to health due to electric shock!

- ▶ All electrical work must be carried out by qualified electricians.

⚠ DANGER

Death or crushing of limbs caused by falling loads!

- ▶ Use lifting gear appropriate for the total weight to be transported.
- ▶ Do not stand under suspended loads

5.5.1 Connecting to power supply

- Connect motor to the rated power supply. Ensure the correct gland is used and that the earth connection is made and secured.
- Run the pump slowly to ensure correct rotation.

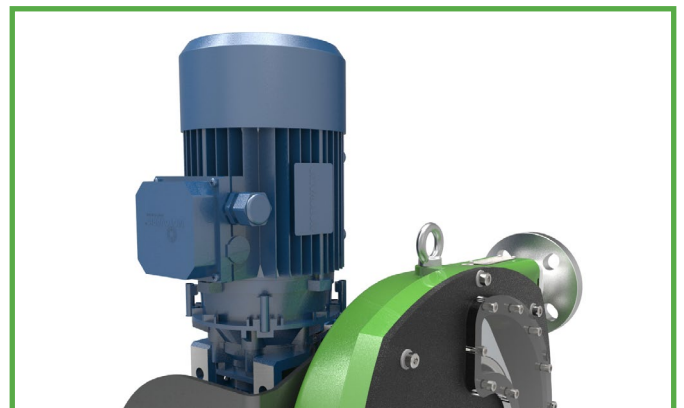

Figure 17 Electrical connection

5.6 Installing the Hose

5.6.1 Inserting the hose



Possible when the motor has been wired up or alternately it can be done by removing the fan cover and rotating the shaft.

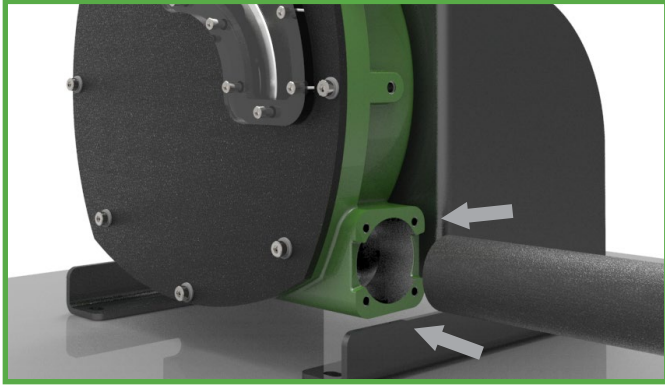

Figure 18 Inserting Hose

1. Add some lubricant to the pump housing.
2. Lubricate the hose generously with Verderlube / Verdersil.
3. Insert the hose into the lower port.
4. Run the pump forward until the hose is fed through the pump casing and is protruding from the port flange mounting face by about 15mm.
 - This can be done either by connecting the pump to a motor that can be run slowly or by manually rotating the shaft after removing the fan cover.

5.6.2 Fitting the port flange (Standard assembly D15 – D35)

✓ Hose in position and protruding about 15mm on the inlet side (the side through which the hose had been inserted).

1. Apply some lubricant compatible with the pumped media to the port flange.

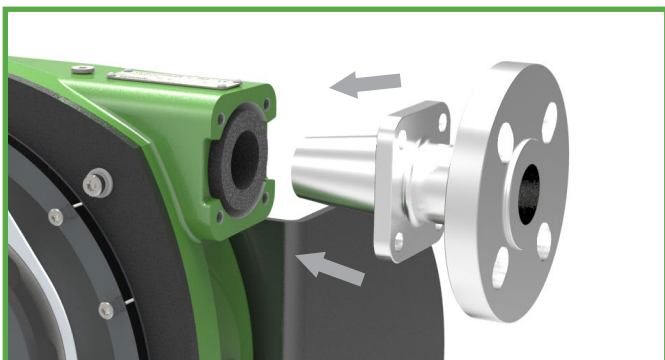

Figure 19 Aligning the port flange

2. Push the port flange-insert into the hose.
3. Install the 4 bolts.
4. Tighten the bolts in a 1–3–4–2 sequence until the flange is evenly fitted, but not completely tightened, leaving about 10mm slack.

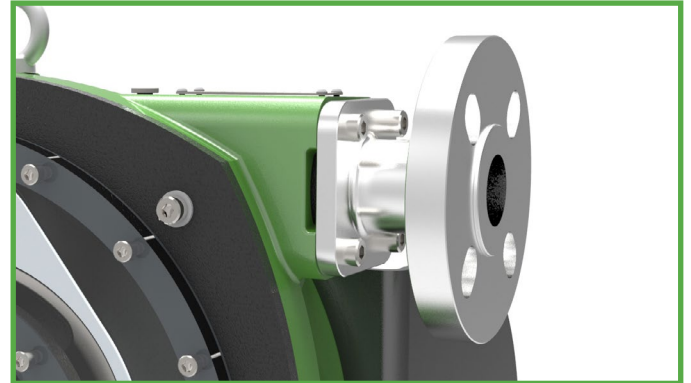

Figure 20 Fitting the port flange

5. Rotate the rotor slowly in a direction to feed the hose onto the taper.
6. Tighten all 4 bolts fully to clamp the hose and ensure the hose can be seen through the aperture in the side of casing formed between the flange and the casing.
7. Run the pump forward and stop when the hose protrudes from the other end by about 15mm
8. Repeat the sequence for installing the flange (refer points 1-6)

5.6.3 Fitting the port flange (Standard Dura 5,7,10 assembly)

✓ A Dura10 flange assembly has an additional Clamp ring to enable easier flange insertion and hose change.

1. Insert one end of the hose into the mouth of the suction port (the hose should be fed into the pump in the direction of normal operation).

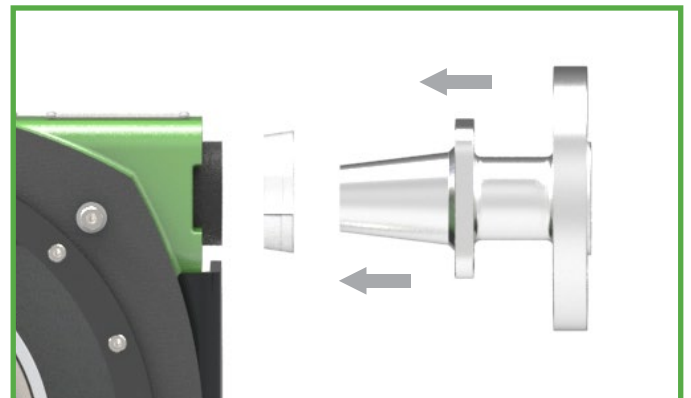

Figure 21 Installing the Dura10 flange

2. Once the hose reaches the rotor, the drive can be inched forward slowly to feed in the remainder of the hose into the pump housing.
3. Leave 15mm hose protruding out of the suction port to fit the clamp ring.
4. Slide on the clamp ring with the smallest diameter facing the pump; and till the clamp ring is inside and in level with the pump housing.
5. And follow steps from 5.6.1 to complete assembly

5.6.4 Fitting the port flange (D15 – D35 Split flange assembly)

- ✓ Hose in position and protruding about 15mm on the inlet side (the side through which the hose had been inserted)
1. Place both halves of the steel flange assembly around the appropriate hose insert.
 2. Screw the halves together with the screws provided and tighten with a screwdriver, use a smear of grease on the screw threads to help avoid seizure.
 3. The flanges are then assembled into the hoses on the pump as per the standard solid flange assembly. (Refer 5.6.2)
 4. It is recommended the flange bolts be installed with a small amount of grease smeared on the thread.

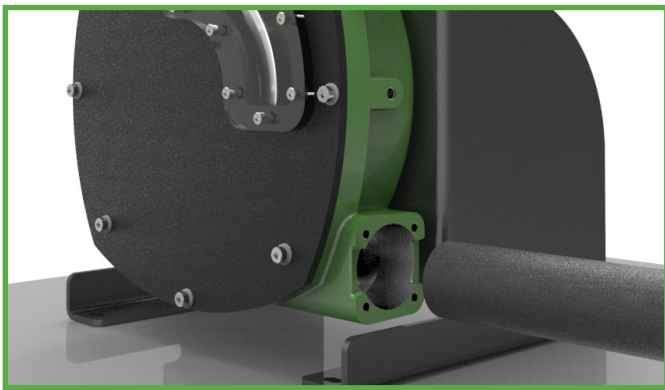

Figure 22 Installing the split flange

5.6.5 Fitting the port flange (D05 – D10 Split flange assembly)

- ✓ A Dura 05 – D10 flange assembly has an additional Clamp ring to enable easier flange insertion and hose change.
1. Leave 15mm hose protruding out of the suction port to fit the clamp ring.
 2. Slide on the clamp ring with tapered side facing away from the pump; allow the hose to protrude 25mm past the clamp ring.
 3. And follow steps from 5.6.4 to complete assembly

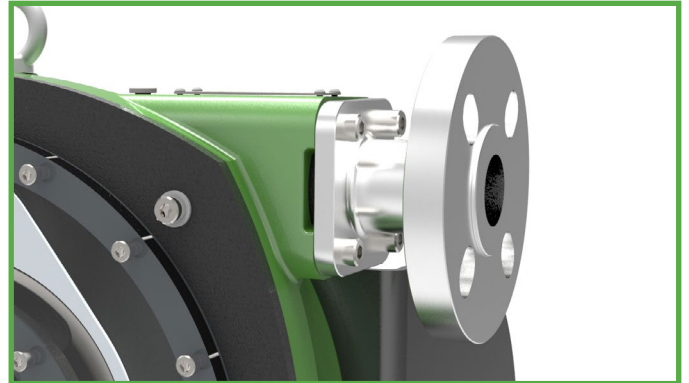

Figure 23 Installing the Dura 05 - 10 split flange

5.6.6 Filling the pump with lubricant

i The safety data sheets for both Verderlube and Verdertil are available from the manufacturer for compatibility check.

1. Provide a suitable container to collect split lubricant.
 2. Ensure compatibility of lubricant with the pumped liquid.
- Fill the pump casing with lubricant to the lowest bolt hole of the inspection window (→ 10.1.6 Lubricants).

5.7 Connecting the pipes

NOTE

Contamination of pumped media due to impurities in the pump!

► Care should be taken to avoid ingress of contaminants into the pumped media.

1. Clean all piping parts and fittings prior to assembly.
2. Ensure that the flange seal do not protrude inwards occluding the flow path.
3. Remove flange covers on both the suction and discharge side prior to installation.

5.7.1 Installing the piping

1. Check all fasteners are tightened (→ 10.1.3 Tightening torques)
2. Remove the transport and sealing covers from the pump.
3. Before connecting any piping to the pump: Ensure that the hose is properly secured by running the pump dry for 10–20 revolutions in both the directions.
4. Run the pipes in a continuous upward or downward slope to avoid air pockets
5. Connect the piping

6. Operation

6.1 Pre-commissioning the pump

6.1.1 Checking the direction of rotation with dry pump

1. Ensure the pump has lubricant in it
2. Switch the motor on and check the direction of rotation; switch immediately off again.
3. If the direction of rotation is different: swap two of the phases (*check with electrician)

6.1.2 Starting the pump

 **DANGER**

Risk of injury and poisoning due to pumped liquid spraying out!

- ▶ Use personal protective equipment when carrying out any work on the pump.

 **WARNING**

Risk of injury and poisoning due to hazardous pumped liquids!

- ▶ Safely collect any leaking pumped liquid and dispose of it in accordance with environmental rules and requirements.

 **DANGER**

Equipment damage due to excess pressure!

- ▶ Do not operate the pump with the discharge-side fitting closed.
- ▶ Operate the pump only inside the tolerances specified by the manufacturer (→ 10.1 Technical specifications)

- ✓ Pump set up and connected properly
- ✓ Motor set up and connected properly
- ✓ All connections stress-free and sealed
- ✓ Pump housing lubricant level correct (→ 10.1.6 Lubricants).
- ✓ All safety equipment installed and tested for functionality

1. Close all drainage taps.
2. Open the suction-side and the discharge-side fittings.
3. Switch on the motor and make sure it is running smoothly.
4. Run the pump, flushing with water first (cold commissioning) to check for leaks.

5. Verify that neither the pump unit nor the pipe connections are leaking.
6. Perform a second flush by running the pump, 10–20 revolutions with pumped liquid, to remove residue and water inside the pump.

6.1.3 Switching off

NOTE

Risk of dead heading and hose burst due to closed suction or discharge!

- ▶ Keep the suction and discharge side fittings opened till the rotor has come to a complete stop.

 **WARNING**

Risk of injury due to hot pump parts!

- ▶ Use personal protective equipment when carrying out any work on the pump.

NOTE

Equipment damage due to sediments!

- ▶ If the pumped liquid crystallizes, polymerizes or solidifies:
 - Flush pump
 - Make sure that the flushing liquid is compatible with the pumped liquid.

1. If necessary: Flush and empty the pump.
2. Switch off power to the motor.
3. Close the discharge side fitting.
4. Check all tie bolts and tighten them if necessary (only after putting the pump into service for the first time).

6.2 Operation

6.2.1 Switching on

DANGER

Risk of injury due to running pump!

- ▶ Do not touch the moving parts of a running pump.
- ▶ Do not carry out any repair/ maintenance work on the running pump.
- ▶ Allow the pump to cool down completely before starting any work on the unit.

DANGER

Risk of injury and poisoning due to pumped liquid spraying out!

- ▶ Use personal protective equipment when carrying out any work on the pump.

NOTE

Risk of pulsation when throttling down the suction flow rate!

- ▶ Fully open the suction-side fitting and **DO NOT** use it to adjust the flow as this could damage the hose.

- ✓ Pump pre-commissioned (→6.1)
- ✓ Pump prepared and filled

1. Open the suction-side and the discharge-side fittings.
2. Switch on the motor and make sure it is running smoothly.

6.2.2 Switching off (Refer to → 6.1.3)

WARNING

Risk of injury due to hot pump parts!

- ▶ Use personal protective equipment when carrying out any work on the pump.

NOTE

Damage to hose due to sediments!

- ▶ If the pumped liquid crystallizes, polymerizes or solidifies
 - Flush the hose
 - Make sure that the flushing liquid is compatible with the pumped liquid.

6.3 Shutting down the pump

- ▶ Take the following measures whenever the pump is shut down:

Pump is	Measure
shut down	▶ Take measures according to the pumped liquid (→ Table 6 Measures depending on the behaviour of the pumped liquid).
...dismounted	▶ Isolate the motor from its power supply and secure it against unauthorized switch-on.
...put into storage	▶ Follow the storage instructions (→ 8 Storage).

Tab. 5 Measures to be taken if the pump is shut down

Behaviour of the pumped liquid	Duration of shutdown (depending on process)	
	Short	Long
crystallized or polymerized, Solids sedimenting	▶ Flush the pump.	▶ Flush the pump, remove the hose.
Solidifying non-corrosive	▶ Heat up or empty the pump	▶ Empty the pump
Solidifying corrosive	▶ Heat up or empty the pump	▶ Empty the pump. ▶ Treat the pump with preservative.
Liquid, non-corrosive	-	-
Liquid, corrosive	▶ Empty the pump	▶ Empty the pump. ▶ Treat the pump with preservative.

Tab. 6 Measures depending on the behaviour of the pumped liquid

6.4 Start-up following a shutdown period

1. After a prolonged shutdown period, re-commission the pump as follows:
 - Replace the seals.
 - Install or change hose (→ 5.6 Hose change).
2. Carry out all steps as for the initial start-up (→ 6.1 Pre commissioning the pump).

6.5 Operating the stand-by pump

- ✓ Stand-by pump is filled with lubricant (→5.6.4 Filling pump with lubricant)
- ▶ Operate the stand-by pump at least once a week to avoid formation of permanent dents/setting on the hose.

7. Maintenance

 Only trained service technicians should be employed for fitting and repair work. Present a pumped medium certificate (DIN safety data sheet or safety certificate) when requesting service.

 **DANGER**

Risk of injury due to running pump or hot parts!

- ▶ Do not carry out any repair/maintenance work on a pump in operation.
- ▶ Allow the pump to cool down completely before starting any repair work.

 **DANGER**

Risk of injury due to pressure buildup!

- ▶ Do not carry out any repairs/maintenance work on a pump in operation
- ▶ Do not block the breather tube which is designed for pressure relief
- ▶ In the unlikely event of a hose burst which leads to blockage of the breather tube - safely relieve the pressure inside the casing before disassembling the pump

 **WARNING**

Risk of injury and poisoning due to hazardous pumped liquids!

- ▶ Use protective equipment when carrying out any work on the pump.

7.1 Inspections

 The inspection intervals depend on the pump operating cycle.

1. Check at appropriate intervals:
 - Normal operating conditions unchanged
2. For trouble-free operation, always check the following:
 - Lubricant level
 - No leaks
 - No unusual running noises or vibrations
 - Hose in position

7.2 Maintenance

 These pumps are generally maintenance free and any work should normally be limited to inspections and pump lubricant changes as required; these may be more frequent in dust and/or hot condition.

 **DANGER**

Risk of electrocution!

- ▶ Have all electrical work carried out only by qualified electricians.

7.2.1 Cleaning the pump

NOTE

High water pressure or spray water can damage motors!

- ▶ Do not clean motors with water or steam jet.
 1. Clean large-scale grime from the pump.
 2. Rinse the hose carefully to remove chemicals (follow the cleaning protocol as listed in → 8.1.2 Cleaning protocol for hoses).

7.2.2 Maintenance schedule

Task	Frequency	Action
Check pump and gearbox for leaks and damage	<ul style="list-style-type: none"> – Before pump start up – Daily visual inspection – Scheduled intervals during operation 	<ul style="list-style-type: none"> ▶ Repair leaks and damage before operating the pump ▶ Replace components as necessary. ▶ Clean up any spillage.
Check pump housing lubrication level	<ul style="list-style-type: none"> – Before pump start up – Daily visual inspection – Scheduled intervals during operation 	<ul style="list-style-type: none"> ▶ Make sure that lubricant level is visible in the inspection window between the lower sill and the first pair of bolts. ▶ Do <u>not</u> operate the pump if the level is too low or too high. Refill lubricant as required (→5.6.3 Lubricant refill)
Check geared motor unit lubrication level	<ul style="list-style-type: none"> – Before pump start up – Daily visual inspection – Scheduled intervals during operation 	<ul style="list-style-type: none"> ▶ → Motor instruction manual.
Check pump for unusual temperatures or noise in operation	<ul style="list-style-type: none"> – Daily visual inspection – Scheduled intervals during operation 	<ul style="list-style-type: none"> ▶ Check pump, gearbox and bearing housing for damage. ▶ Replace worn components.
Replace pump housing lubricant	<ul style="list-style-type: none"> – At every hose change or every six months – After inspection when required 	<ul style="list-style-type: none"> ▶ Refill lubricant (→5.6.3 Lubricant refill)
Replace hose	<ul style="list-style-type: none"> – After inspection when required – When flow has dropped by 25% of nominal value – When the hose is burst/damaged 	<ul style="list-style-type: none"> ▶ Replace hose (→ 7.4 Hose change) ▶ Replace flange sealing kit
Check pump housing, rotor, rotor shoes and inserts internally	<ul style="list-style-type: none"> – Annually – On replacing the hose 	<p>Worn and damaged surfaces give rise to premature hose failure</p> <ul style="list-style-type: none"> ▶ Replace worn components. ▶ Check bearing play and function.
Replace bearing housing	<ul style="list-style-type: none"> – After 30,000 running hours – When damage is suspected 	<ul style="list-style-type: none"> ▶ Check bearing play and function.
Replace bearing housing seal	<ul style="list-style-type: none"> – When damage is suspected – When leak is detected 	<ul style="list-style-type: none"> ▶ Replace worn components.

Tab. 7 Maintenance schedule

7.3 Repairs

 **DANGER**

Risk of death due to electric shock!

- ▶ Have all electrical work carried out by qualified electrician only

 **WARNING**

Risk of injury due to heavy components!

- ▶ Pay attention to the component weight. Lift and transport heavy components using suitable lifting gear.
- ▶ Set down components safely and secure them against overturning or rolling away.

7.3.1 Preparations for dismounting

 **WARNING**

Risk of injury while dismounting the pump!

- ▶ Use protective equipment when carrying out any work on the pump.
Observe manufacturer's instructions (e.g. for Motor, coupling, gearbox).

- ✓ Safely release any pressure build up in the pump housing. (There may be significant built up of pressure in the discharge line or possible suction side vacuum).
- ✓ Pump completely emptied, flushed and decontaminated
- ✓ Electrical connections disconnected and motor locked out against being switched on again
- ✓ Pump cooled down
- ✓ Auxiliary systems shut down, depressurized and emptied
- ✓ Before dismounting the pump, mark the precise orientation and position of all components before dismounting them.

7.3.2 Returning the pump to the manufacturer

- ✓ Pump unpressurized
- ✓ Completely emptied and decontaminated.
- ✓ Pump cooled down
- ✓ Hose dismantled (→7.4.1 Dismounting the hose)

Obtain prior authorization before repair or return of the pump.

- ▶ Enclose a completed document of compliance when returning pumps or components to the manufacturer

Repairs	Measure for return
...at the customer's premises	<ul style="list-style-type: none"> – Return the defective component to the manufacturer. – Decontaminate if necessary.
...at the manufacturer's premises	<ul style="list-style-type: none"> – Flush the pump and decontaminate it if it was used for hazardous pumped liquids.
...at the manufacturer's premises for warranty repairs	<ul style="list-style-type: none"> – Only in the event of hazardous pumped liquid, flush and decontaminate the pump

Tab. 8 Measures for return

7.3.3 Rebuild / Repair

-  Reinstall the components, in accordance with the marks applied.

NOTE

Material damage due to unsuitable components!

- ▶ Always replace lost or damaged bolts with bolts of the same strength and material.

1. Observe the following during the installation:
 - Replace worn parts with genuine spare parts.
 - Maintain the prescribed tightening torques (→ 10.1.3 Tightening torques)
2. Clean all parts (→ 10.1.5 Cleaning agents). Do not remove any markings which have been applied.
3. Reassemble the pump (→ refer sectional drawing).
4. Install the pump in the system (→ 5 Installation and connection)

7.4 Hose change

WARNING

Risk of injury!

- ▶ Always isolate the power supply before working on the pump.

-  The hose change involves removal and re-installing the port flanges.

7.4.1 Dismounting the hose

▶ Draining lubricant

- ✓ Motor isolated.
- ✓ System secured against being switched back on again.

WARNING

Slip hazard due to spilt lubricant!

- ▶ Care must be taken when lubricant is drained into a container.
- ▶ Dispose of used lubricant in accordance with local laws and good environmental practices.

1. Remove the drain plug at the rear of the pump.
2. Drain the lubricant into a suitable container.
3. Remove the lower flange and allow any excess lubricant to drain out.

▶ Removing the hose

CAUTION

Risk of injury if the hose is expelled too quickly

- ▶ Slowly remove the hose by running the motor at a reduced speed

1. Remove both the flanges.
2. Use the motor to drive out the old hose. If no power is available, remove the fan cover and turn the fan shaft by hand or using suitable leverage.
3. Clean the pump housing.
4. Inspect the flanges for damage and signs of wear.

7.4.2 Re-installing the hose, port flanges, lubricant refill and fitting the inspection window

- Follow step by step, the instructions listed in section → 5.6 (Installing the hose)

7.5 Ordering spare parts

 For trouble-free replacement in the event of faults, we recommend keeping spare parts available on site.

- ▶ The following information is mandatory when ordering spare parts (→ Name plate):
 - Pump model
 - Year of manufacture
 - Part number / Description of part required
 - Serial number
 - Quantity

8. Storing pumps and hoses

Verderflex pumps are designed for continuous use, however, there may be instances when pumps are withdrawn from use and stored for extended periods. We recommend certain pre-storage actions and precautions be taken whilst pumps and their components are not in use.

Similarly, hoses and lubricants may be held in stock to service working pumps and their recommended storage conditions are advised.

8.1.1 Pre-Storage Actions

- The hose should be removed from the pump and lubricant drained out from the pump casing.
- The pump casing should be washed out allowed to dry and any external build up of product removed.

8.1.2 Cleaning Protocol for hoses

VERDERFLEX hoses should be cleaned with the following protocol –

NBRF Hoses:

- ▶ VERDERFLEX NBRF food grade hoses should be cleaned with the following protocol:
 - 1 First flush 0.5% Nitric Acid (HNO₃) solution at up to 60°C
 - 2 Second flush 4% Caustic soda (NaOH) solution and eventually steamed open ends for 15 minutes at up to 110°C
 3. Final flush: flush with clean water to remove all traces of cleaning solutions

Under no circumstances should VERDERFLEX NBRF food grade hoses be cleaned with Sodium hypochlorite (NaOCl) based cleaning solutions, neither should the above concentrations, exposure, durations or temperatures be exceeded.

▶ EHEDG Approval

VERDERFLEX NBRF food grade hoses can be used with suitably specified VERDERFLEX pumps to form an EHEDG accredited hygienic pumping system. To comply with this certification both the approved particle velocity must be maintained during the cleaning cycle and the appropriate hygienic port flanges fitted. Should a pump to this specification be required, it should be agreed with your local VERDERFLEX distributor before the pump is supplied.

▶ Food Grade Approval

All VERDERFLEX NBRF food grade hoses' inner liners are certified as compliant to FDA – CFR 21 Parts 170 to 189 – Item 177.2600

▶ Hose Description

All VERDERFLEX NBRF food Grade hoses consist of a smooth black inner food grade liner bonded to a non-food grade outer. The inner liner is a taste-free and odourless.

▶ Hose Installation

All VERDERFLEX NBRF food Grade hoses must be installed in accordance with the procedures defined in the VERDERFLEX Operating and Maintenance manual.

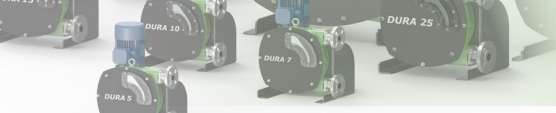

► **Identification**

VERDERFLEX NBRF food Grade hoses can be identified by:

- a) Both an external Yellow Coding / Identification tape and an additional white longitudinal stripe
- b) On supply as a spare part, they will have their endssealed with Aluminium foil

► **Pump Installation**

VERDERFLEX pumps using VERDERFLEX NBRF Food Grade hoses must be installed in accordance with recommendations made by the pump’s supplier. In particular, special care must be given to the suction and discharge line conditions and that the hose is shimmed in accordance with VERDERFLEX’s recommendations. Should there be any doubt about any installation details, these must be discussed with the pumps’ supplier.

► **Particle Release**

All hoses will release small quantities of rubber into the product stream, especially immediately after the hose installation and just prior to hose failure. Whilst the rubber released will be food grade particles, these may cause end-user concerns about contamination and so we recommend suitable particle capturing devices such as filters are fitted into the pump’s discharge line.

8.1.3 Storage Conditions

- Pumps should be stored in a dry environment, out of direct sunlight. Depending on these conditions, it may be advisable to place a moisture-absorbing product, such as Silica gel, inside the pump’s casing or to coat the pump’s inner surfaces with moisture-repelling oil, such as WD40, whilst the pump is stored.
- Gearboxes may require intermittent attention as indicated by the gearbox manufacturer’s recommendations.
- Hoses should be stored as supplied in their wrapper and should be stored away from direct sunlight, flat without any bends or kinks and at room temperature, with end caps fitted.
- Lubricants should be stored under normal warehouse conditions with their caps securely fastened.

9. Troubleshooting

9.1 Pump malfunctions

If malfunctions occur which are not specified in the following table or cannot be traced back to the specified causes, please consult the manufacturer.

Possible malfunctions are identified and respective cause and remedy are listed in the table.

Abnormally high pump temperature	Low flow/pressure	Pump and pipe-work vibrating	Hose pulled in to pump housing	Possible Cause		Remedy	
				Possible Cause	Remedy		
X	-	-	-	Incorrect lubricant	▶ Consult the manufacturer to obtain correct lubricant.		
				Low lubricant level	▶ Add required amount.		
				Product ambient temperature too high	▶ Consult the manufacturer regarding maximum temperature.		
				Over shimming of the pump	▶ Check for and remove excess shims.		
X	X	-	-	Blocked suction / bad suction characteristics / no product	▶ Check pipe-work and valves for blockages. ▶ Check that the suction pipe-work is as short and as large in diameter as feasible. ▶ Correct the piping layout. ▶ Consult the manufacturer.		
X	-	X	-	High pump speed	▶ Reduce speed to a minimum. ▶ Consult the manufacturer.		
-	X	-	-	Suction/discharge valve closed	▶ Open suction/discharge valve.		
				Hose failure	▶ Replace hose(→ 7.4 Hose change)		
				Poor pump selection, incorrect shoe shimming	▶ Consult the manufacturer to check pump selection.		
				Suction line too long	▶ Consult the manufacturer.		
				Pump speed too high	▶ Consult the manufacturer.		
				Suction line bore too small	▶ Consult the manufacturer.		
				High product viscosity	▶ Consult the manufacturer.		
				Suction/discharge lines not secured properly	▶ Check and secure suction/discharge lines.		
-	-	X	-	Long suction/discharge lines / Damper malfunction	▶ Shorten long suction/discharge lines wherever possible. ▶ Consult the manufacturer.		
				High product specific gravity / viscosity	▶ Consult the manufacturer.		
				Under-sized suction/discharge diameter	▶ Increase suction/discharge pipe-work diameter. ▶ Fit damper.		
				Insufficient lubricant in the casing	▶ Check lubrication chart and add the required amount of lubrication.		
-	-	-	X	Inlet pressure too high	▶ Reduce the inlet pressure.		
				Blocked hose / incorrectly fitted	▶ Check the hose and remove any blockages.		
				Large particles in the product	▶ Mount sieve or filter in suction line to avoid very large particles from entering the hose. <u>Do not</u> allow filters to limit suction below accepted levels.		

Tab. 9 Pump troubleshooting list

10. Appendix

10.1 Technical Specifications

10.1.1 Pump Specifications

Size	Value	
Max. delivery pressure	Dura 5-7	8 bar
	Dura 10-25	12 bar
	Dura 35	16 bar
Temperature of pumped liquid	< 100 °C	
Max. continuous operation pump speeds	*(refer pump datasheet)	
Dimensions	*(refer pump datasheet)	

Tab. 10 Pump Specifications

10.1.2 Ambient conditions

 Operation under any other ambient condition would require approval from the manufacturer

Operating conditions

- Ambient temperature –5 °C to +45 °C
- Relative humidity – long—term ≤ 85 %
- Setup height above sea level ≤ 1000

Storage conditions

- Ambient temperature +10 °C to +50 °C
- Relative humidity – long—term ≤ 85 %

10.1.3 Tightening torques

 Tightening torques should be applied at the below mentioned torque values:

Position	Torque values (Nm)			
	D5,7,10	D15	D25	D35
Inspection Window	3.4	3.4	3.4	3.4
Port flange	12	12	27	27
Rotor	12	12	27	27
Frames to casing	7	7	10	10
Front cover	12	12	27	27
Torque arm	12	12	27	27
Gear box	7	7	7	14

Tab. 11 Pump fastener tightening torques

10.1.4 Preservatives

 Use e.g. RUST-BAN 335 or similar preservatives on bare metal.

10.1.5 Cleaning agents (After hose is removed)

Cleaning agents
Wax solvents, diesel paraffin, alkaline cleaners, Warm Water

Tab. 12 Cleaning agents

10.1.6 Lubricants

 Recommended lubricants for longer hose life are VERDERLUBE or VERDERSIL.

Pump type	Amount of Lubricant
Dura 5	0.25 Ltrs (0.06 US Gallons)
Dura 7	0.25 Ltrs (0.06 US Gallons)
Dura 10	0.25 Ltrs (0.06 US Gallons)
Dura 15	0.50 Ltrs (0.13 US Gallons)
Dura 25	2.0 Ltrs (0.53 US Gallons)
Dura 35	2.5 Ltrs (0.66 US Gallons)

Tab. 13 Amount of Lubricant cover.

*The pump is filled to the lowest screw hole on the window.

10.1.7 Rotor options

 Verderflex Dura 5-35 range has standard and high pressure rotor options:

Pump type	Rotor option (bars)	
	Standard	High Pressure
Dura 5	5 bar	8 bar
Dura 7	5 bar	8 bar
Dura 10	6 bar	12 bar
Dura 15	6 bar	12 bar
Dura 25	6 bar	12 bar
Dura 35	6 bar	16 bar

Tab. 14 Rotor options

10.2 List of Figures and Tables



10.2.1 List of figures

Figure 1	Name plate	3.2.1
Figure 2	Layout (Generic view)	3.3
Figure 3	Fastening lifting gear to pump unit	4.1.2
Figure 4	Inserting shaft seal	5.4.1
Figure 5	Fitting the filler tube	5.4.1
Figure 6	Fitting the frames	5.4.1
Figure 7	Applying lubricant on drive shaft	5.4.2
Figure 8	Installing the drive shaft	5.4.2
Figure 9	Inserting the crescent ring	5.4.2
Figure 10	Installing the rotor	5.4.3
Figure 11	Inserting the O-ring (front cover assembly)	5.4.4
Figure 12	Installing the front covert	5.4.4
Figure 13	Placing the inspection window gasket	5.4.4
Figure 14	Fitting the torque arm	5.4.5
Figure 15	Aligning the drive shaft	5.4.5
Figure 16	Fastening the torque arm	5.4.5
Figure 17	Electrical connection	5.5.1
Figure 18	Inserting hose	5.6.1
Figure 19	Aligning the port flange	5.6.2
Figure 20	Fitting the port flange	5.6.2
Figure 21	Installing the Dura10 Flange	5.6.3
Figure 22	Installing split flange	5.6.4
Figure 23	Installing the Dura 05 - 10 split flange	5.6.5

10.2.2 List of tables

Table 1	Target groups	1.1
Table 2	Warnings and consequences of disregarding them	1.2
Table 3	Symbols and their meaning	1.2
Table 4	Do's and Don'ts	5.3
Table 5	Measures to be taken if the pump is shut down	6.3
Table 6	Measures depending on behaviour of the pumped liquid	6.3
Table 7	Maintenance schedule	7.2.2
Table 8	Measures for return	7.3.2
Table 9	Pump troubleshooting list	9.1
Table 10	Pumps specifications	10.1.1
Table 11	Pump fastener tightening torques	10.1.3
Table 12	Cleaning agents	10.1.5
Table 13	Amount of Lubricant	10.1.6
Table 14	Table option	10.1.7
Table 15	Declaration of conformity according to EC Machine Directive	10.3

10.3 Declaration of conformity according to EC Machine Directive

<p>EC declaration of conformity according to machine directive, appendix II A</p> <p>We, VERDER Ltd., Unit 3 California Drive, Castleford hereby declare that the following machine adheres to the relevant EC directives detailed below</p> <p>Designation Dura 05 Dura 07 Dura 10 Dura 15 Dura 25 Dura 35</p> <p>EC directives:</p> <ul style="list-style-type: none"> • Machine Directive (2006/42/EC) • Low-voltage directive (2006/95/EC) • EMC directive (2004/108/EC) <p>Applicable harmonized norms:</p> <ul style="list-style-type: none"> • EN ISO 12100: 2010 		
Responsible for the documentation	VERDER Ltd. Unit 3 California Drive Castleford WF10 5QH UK	
Date: 01/ 03/ 2013	Company stamp / signature:  David Sampson <i>Head of Development/Construction</i>	Company stamp / signature:  David Hoyland <i>Head of Quality</i>

Tab. 15 Declaration of conformity according to EC Machine Directive



motralec

4 rue Lavoisier . ZA Lavoisier . 95223 HERBLAY CEDEX
Tel. : 01.39.97.65.10 / Fax. : 01.39.97.68.48
Demande de prix / e-mail : service-commercial@motralec.com

www.motralec.com