

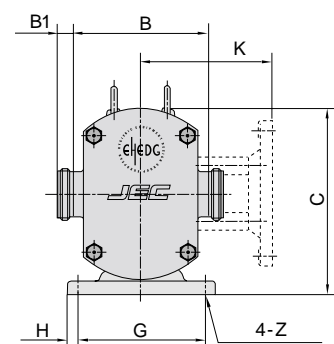

"The reliable choice for your process"

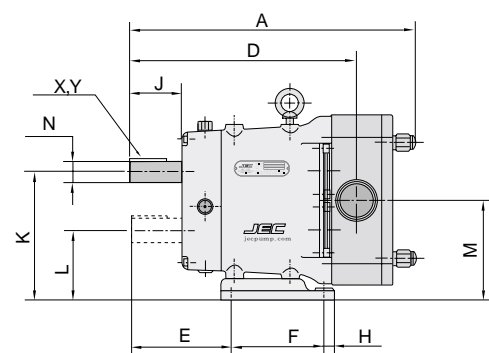

Model No	ports	Dimensions															
		A	B	C	D	E	F	G	H	J	K	L	M	N	X	Y	Z
JRZL110-005-20	1"	255	152	200	218	96	84	134	12	50	141	77	109	23	30	8	9
JRZL115-012-12	1 1/2"	264	152	222	218	96	84	134	12	50	141	77	109	23	30	8	9
JRZL120-021-08	2"	284	152	230	218	96	84	134	12	50	141	77	109	23	30	8	9
JRZL220-040-12	2"	386	188	264.5	305	129	132	180	15	60	185	101	143	32	50	10	11
JRZL225-062-08	2 1/2"	406	188	264.5	315	129	132	180	15	60	185	101	143	32	50	10	11
JRZL330-102-12	3"	533	242	347.5	390	159	160	242	22	70	243.5	128.5	186	45	60	14	13
JRZL340-144-08	4"	546	242	347.5	402	159	160	242	22	70	243.5	128.5	186	45	60	14	13
JRZL440-227-12	4"	674	324	458	506	199	210	320	30	80	324	170	247	55	87	14	15
JRZL450-334-08	5"	709	324	458	523	199	210	320	30	80	324	170	247	55	87	14	15

Model No	ports	Dimensions B1					Weight KG	Volume CBM
		ISO	BS	DIN	SMS	FLANGE		
JRZL110-005-20	1"	20	26	30	20	30	12	0.01
JRZL115-012-12	1 1/2"	20	26	30	20	30	19	0.01
JRZL120-021-08	2"	22	26	30	20	30	23	0.01
JRZL220-040-12	2"	26	26	35	24	35	45	0.03
JRZL225-062-08	2 1/2"	26	26	35	24	35	51	0.03
JRZL330-102-12	3"	28	26	40	24	40	91	0.06
JRZL340-144-08	4"	28	26	40	24	40	103	0.06
JRZL440-227-12	4"	28	26	40	24	40	180	0.15
JRZL450-334-08	5"	28	26	54	35	54	210	0.15

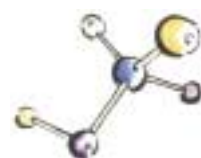

JEC

motralec

4 rue Lavoisier . ZA Lavoisier . 95223 HERBLAY CEDEX
 Tel. : 01.39.97.65.10 / Fax. : 01.39.97.68.48
 Demande de prix / e-mail : service-commercial@motralec.com
www.motralec.com

JEC - Always a Step Ahead

JRZL SERIES ROTARY LOBE PUMPS

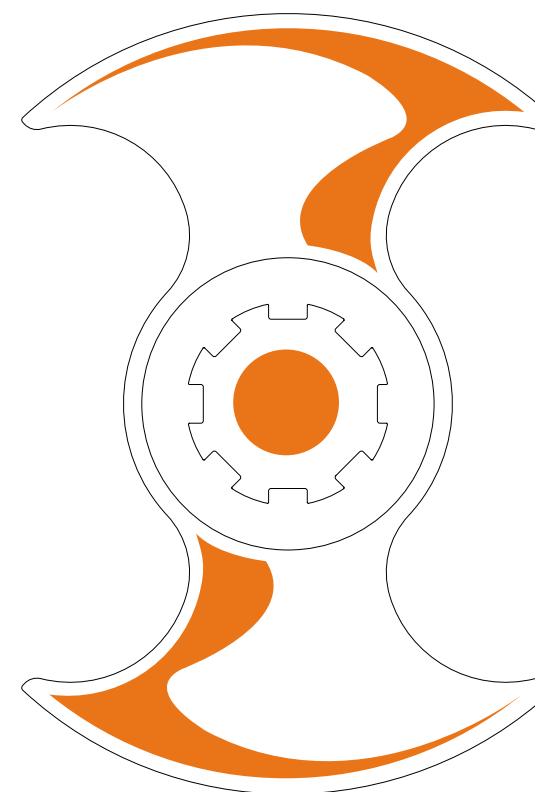

JEC
P U M P S

3P

High Pride
Higher Performance
Highest Quality

3P



JEC Ltd. specialise in the field of sanitary pumps.

JEC was established in 1990 and started producing sanitary pumps utilising precision cast and pressed parts for the first time in Korea. Since then JEC has been successfully supplying to the process industries centrifugal, rotary and self-priming pumps, as well as blenders. JEC pumps are now renowned for reliability both for general duties and special applications. JEC's success is built upon high quality manufacture and customer satisfaction. Our policy is one of long term vendor partnerships.

Good relations with our customers are prerequisite to our growth.

JEC considers exchanging ideas their customers of the highest importance.

It is our belief JEC customer support fully meets customer expectations and contributes towards their prosperity.

We are always striving to make every effort to start new initiatives.

The JEC philosophy is one of continuous improvement and keeping promises.



Our pride is created by high quality!

Every feature on the ZL range has been specifically designed to make dismantling (whether for inspection, cleaning, or maintenance) quicker, easier and cheaper. What's more, the forward-seal position places the seals in direct contact with CIP fluids. Superior seal cleanliness lengthens seal life and minimizes seal flaking (product contamination). And because the seals are located directly behind the rotors, areas of product entrapment are eliminated for superior hygienic performance. In fact, the ZL has the EHEDG (European Hygienic Equipment Design Group) certificate for cleanliness from the TNO laboratory in the Netherlands.



JRZL series Rotary Lobe Pumps

JEC - Always a Step Ahead

- The revolutionary, EHEDG (European Hygienic Equipment Design Group) certified, JEC pump, manufactured in 316 stainless steel, the pump sets the standard for uptime reliability and CIP performance.
- Unique front-loading product seal positioning gives faster maintenance, easier cleaning, and less downtime. By removing only the front cover, both rotors and product seals can be fully accessed from the front of the pump without disconnecting the process line.
- Alternatively, a simple O-ring or PTFE lip-seal can be supplied offering easy to change, low-cost options. All seal options listed fit into the same rotor case giving cost-effective changeability, even after the pump has been installed.
- Many applications require the pump head to be heated or cooled to assist in pumping the product, this is simple with the JEC JRZL series pump which can be fitted with rotor case thermal jackets or a front cover thermal jacket as required.
- To handle abrasive products, pump product contact interanls can also be hardened.
- A high grade 0.8 micron Ra surface finish of the 316 type stainless steel pump head components is provided as standard. The 0.4 micron Ra finish can be provided optionally.
- There are truck pumps designed specially for road tanker use.

STANDARD DESIGN

- JEC JRZL series pumps have four kinds of gear boxes with two kinds of rotor housings and will have lobe rotor.
- JEC JRZL series pumps are normally fitted with horizontal ports but simply are fitted with vertical ports.
- A single seal can be easily modified to a double type with a minimum of additional parts required due to its unique modular design.
- Complete connections according to optional standard ISO male, ISO clamp, SMS, DIN, BS and flange.

- The designed bi-wing rotor geometry is maintained throughout the JRZL range of pumps giving high performance and key benefit of interchangeability with single, tri and multi lobe.

PERFORMANCE CURVES

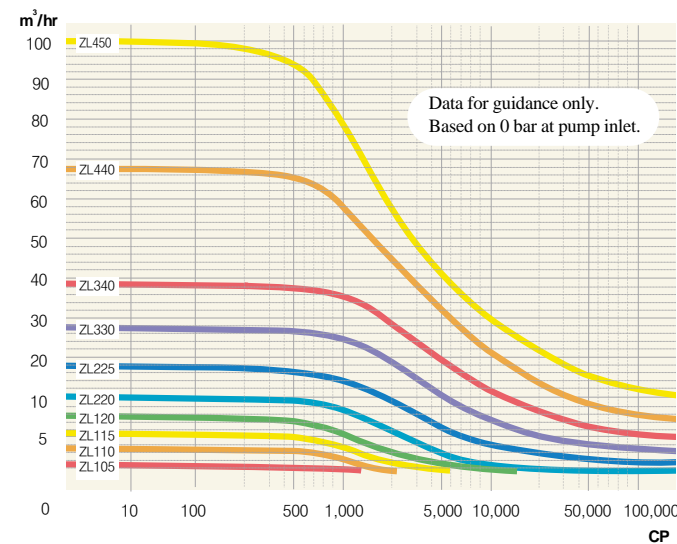

APPLICATION

- JEC JRZL series pumps have been designed to suit all hygienic pumping applications found in the food, dairy, beverage, pharmaceutical and other places where stainless steel is resistant to the liquids to be pumped.
- Both thin and viscous liquids up to 1,000,000 centipoise can be handled with a self-priming capability up to 4m, capacity range up to 100m³/hr and head up to 250m.

SPECIFICATIONS

ZL Series	Model No	Displacement			Standard Connection Size		Max Differential Pressure		Max Speed
		Liters/rev	Int Gal/100rev	US Gal/100rev	mm	Inches	BAR	PSI	Rev/min
100	ZL110-005-20	0.05	1.10	1.32	25	1	20	300	1000
	ZL115-012-12	0.12	2.64	3.17	40	1.5	12	175	800
	ZL120-021-08	0.21	4.61	5.54	50	2	8	115	800
200	ZL220-040-12	0.41	9.01	10.81	50	2	12	175	700
	ZL225-062-08	0.62	13.63	16.35	65	2.5	8	115	700
300	ZL330-102-12	1.02	22.42	26.90	80	3	12	175	600
	ZL340-144-08	1.44	31.65	37.98	100	4	8	115	600
400	ZL440-227-12	2.27	49.90	59.88	100	4	12	175	500
	ZL450-334-08	3.34	73.42	88.10	150	5	8	115	500

*“The higher the precision
the longer the span of product life”*



Tri-lobe Version



Ultra-clean Version



Thermal Jacket Version

SEAL OPTIONS

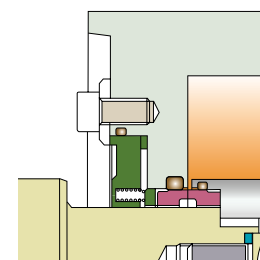

Single Mechanical Seal

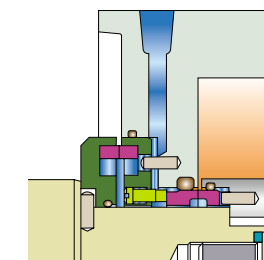

Double Mechanical Seal

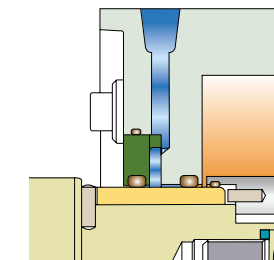

Double O-ring Seal

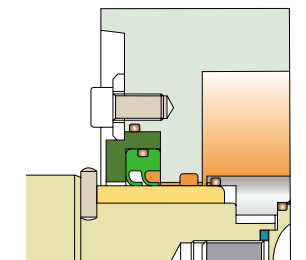

Lip Seal



Our pride is created by high quality!

JEC Sanitary Pumps



“The reliable choice for your process”

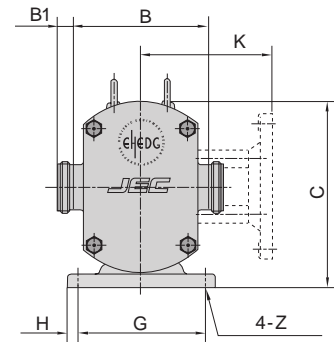
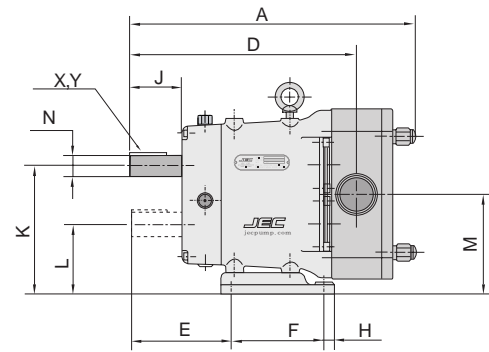

Model No	ports	Dimension															
		A	B	C	D	E	F	G	H	J	K	L	M	N	X	Y	Z
JRZL110-005-20	1"	255	152	200	218	96	84	134	12	50	141	77	109	23	30	8	9
JRZL115-012-12	1 1/2"	264	152	222	218	96	84	134	12	50	141	77	109	23	30	8	9
JRZL120-021-08	2"	284	152	230	218	96	84	134	12	50	141	77	109	23	30	8	9
JRZL220-034-12	2"	386	188	264.5	305	129	132	180	15	60	185	101	143	32	50	10	11
JRZL225-052-08	2 1/2"	406	188	264.5	315	129	132	180	15	60	185	101	143	32	50	10	11
JRZL330-102-12	3"	533	242	347.5	390	159	160	242	22	70	243.5	128.5	186	45	60	14	13
JRZL340-144-08	4"	546	242	347.5	402	159	160	242	22	70	243.5	128.5	186	45	60	14	13
JRZL440-227-12	4"	674	324	458	506	199	210	320	30	80	324	170	247	55	87	14	15
JRZL450-334-08	5"	709	324	458	523	199	210	320	30	80	324	170	247	55	87	14	15



Model No	ports	Dimension B1					Weight KG	Volume CBM
		ISO	BS	DIN	SMS	FLANGE		
JRZL110-005-20	1"	20	26	30	20	30	12	0.01
JRZL115-012-12	1 1/2"	20	26	30	20	30	19	0.01
JRZL120-021-08	2"	22	26	30	20	30	23	0.01
JRZL220-034-12	2"	26	26	35	24	35	45	0.03
JRZL225-052-08	2 1/2"	26	26	35	24	35	51	0.03
JRZL330-102-12	3"	28	26	40	24	40	91	0.06
JRZL340-144-08	4"	28	26	40	24	40	103	0.06
JRZL440-227-12	4"	28	26	40	24	40	180	0.15
JRZL450-334-08	5"	28	26	54	35	54	210	0.15



JEC - Always a Step Ahead

ROTARY POSITIVE DISPLACEMENT PUMPS JRZL SERIES

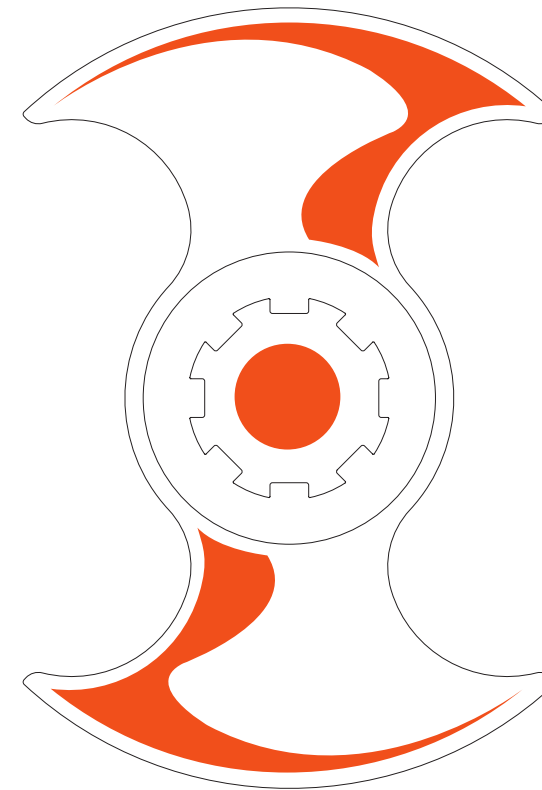

JEC
P U M P S

3IP

High Pride
Higher Performance
The Highest Quality Products



JEC Ltd. is the specialist in the fields of sanitary pumps.

JEC was established in 1990 and started producing the sanitary pumps that were made by precision casting and press for the first time in Korea. Since then, JEC has successfully produced and marketed the processing plants such as rotary pumps, self-priming pumps, and blenders as well as centrifugal pumps. Now we are enjoying a good reputation for specially applied fields as well as general installation demands. JEC's success as good as highest quality manufacturer in the fields of sanitary pumps in the past is attributed to artisanship and customer's belief.

We build up not deals but relationships.

A good relation with customer is prerequisite to our growth.

JEC considers exchanging beliefs with you more important than everything else.

Under JEC's customer's support, we believe that we will meet your full needs, fulfill your expectations, and contribute to customer's further prosperity.

We would like to continue to make every effort so that another progress will be started at JEC.

The JEC philosophy is keeping promises.



Our pride is created by high quality!

Every feature on the ZL range has been specifically designed to make dismantling (whether for inspection, cleaning, or maintenance) quicker, easier, and cheaper.

What's more, the forward-seal position places the seals in direct contact with CIP fluids. Superior seal cleanliness lengthens seal life and minimizes seal flaking (product contamination). And because the seals are located directly behind the rotors, areas of product entrapment are eliminated for superior hygienic performance.

In fact, the ZL has the EHEDG (European Hygienic Equipment Design Group) certificate for cleanliness from the TNO laboratory in the Netherlands.

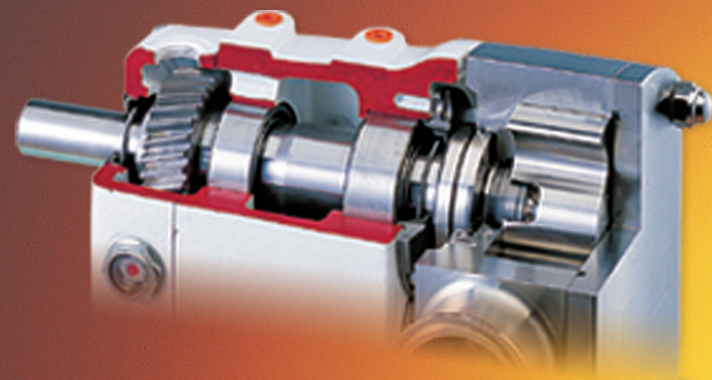

JRZL series Rotary Pumps

JEC - Always a Step Ahead

- The revolutionary, EHEDG (European Hygienic Equipment Design Group) certified, JEC pump, manufactured in 316 stainless steel, the pump sets the standard for uptime reliability and CIP performance.
- Unique front-loading product seal positioning gives faster maintenance, easier cleaning, and less downtime. By removing only the front cover, both rotors and product seals can be fully accessed from the front of the pump without disconnecting the process line.
- Alternatively, a simple O-ring or PTFE Lip-seal can be supplied offering easy to change, low-cost options. All seal options listed fit into the same rotor case giving cost-effective changeability, even after the pump has been installed.
- Many applications require the pump head to be heated or cooled to assist in pumping the product, this is simple with the JEC JRZL series pump which can be fitted with rotor case thermal jackets or a front cover thermal jacket as required.
- To handle abrasive products, pump product contact interanls can also be hardened.
- A high grade 0.8 micron Ra surface finish of the 316 type stainless steel pump head components is provided as standard. The 0.4 micron Ra finish can be provided optionally.
- There are truck pumps designed specially for road tanker use.

STANDARD DESIGN

- JEC JRZL series pumps have four kinds of gear boxes with two kinds of rotor housings and will have lobe rotor.
- JEC JRZL series pumps are normally fitted with horizontal ports but simply are fitted with vertical ports.
- A single seal can be easily modified to a double type with a minimum of additional parts required due to its unique modular design.
- Complete connections according to optional standard ISO male, ISO clamp, SMS, DIN, BS and flange.

- The designed twin lobe rotor geometry is maintained throughout the JRZL range of pumps giving high performance and key benefit of interchangeability with single, tri and multi lobe.

PERFORMANCE CURVE

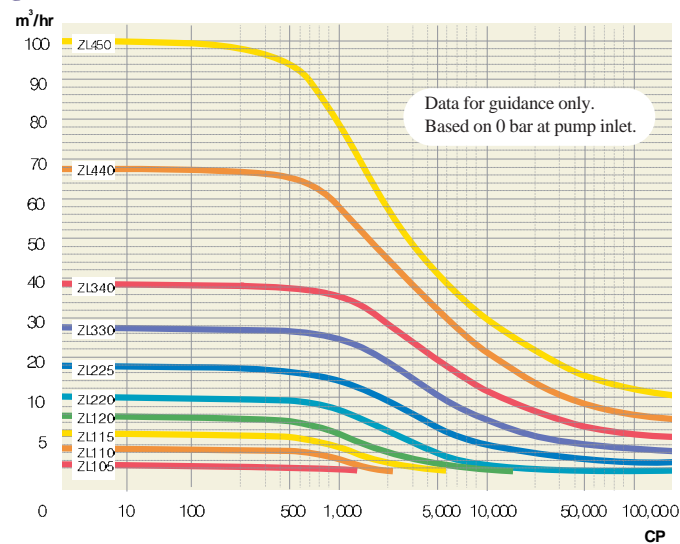

APPLICATION

- JEC JRZL series pumps have been designed to suit all hygienic pumping applications found in the food, dairy, beverage, pharmaceutical and other places where stainless steel is resistant to the liquids to be pumped.
- Both thin and viscous liquids up to 1,000,000 centipoise can be handled with a self-priming capability up to 4m, capacity range up to 100 m³/h and head up to 250m.

SPECIFICATIONS

ZL Series	Model No.	Displacement			Standard Connection Size		Max. Differential Pressure		Max. Speed Rev/min
		Liters/rev	Int Gal/100rev	US Gal/100rev	mm	Inches	BAR	PSI	
100	ZL110-005-20	0.05	1.10	1.32	25	1	20	300	1000
	ZL115-012-12	0.12	2.64	3.17	40	1.5	12	175	800
	ZL120-021-08	0.21	4.61	5.54	50	2	8	115	800
200	ZL220-040-12	0.41	9.01	10.81	50	2	12	175	700
	ZL225-062-08	0.62	13.63	16.35	65	2.5	8	115	700
300	ZL330-102-12	1.02	22.42	26.90	80	3	12	175	600
	ZL340-144-08	1.44	31.65	37.98	100	4	8	115	600
400	ZL440-227-12	2.27	49.90	59.88	100	4	12	175	500
	ZL450-334-08	3.34	73.42	88.10	150	5	8	115	500

*“The higher the precision we have,
the longer the span of product life we have”*

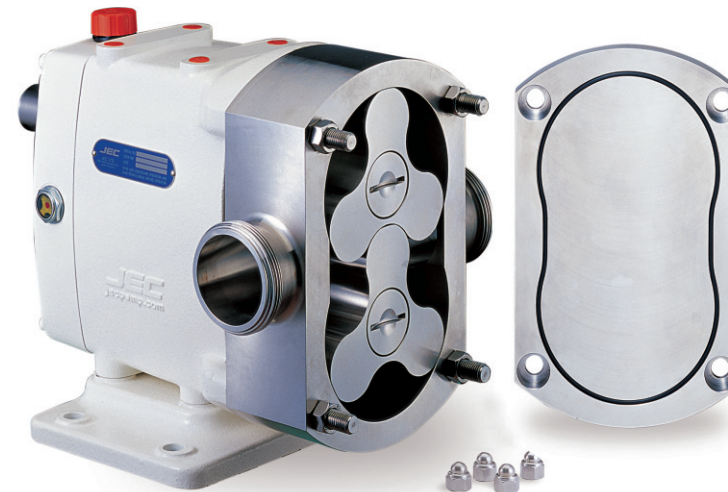

Tri-Lobe Version



Ultra-Clean Version

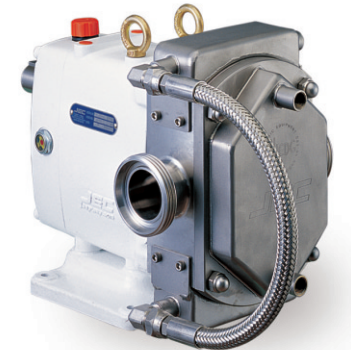

Thermal Jacket Version

SEAL OPTIONS

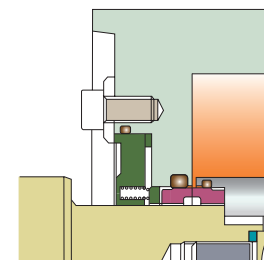

Single Mechanical Seal

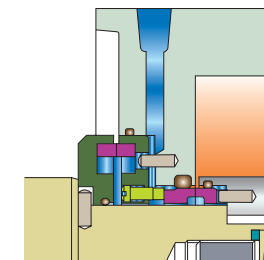

Double Mechanical Seal

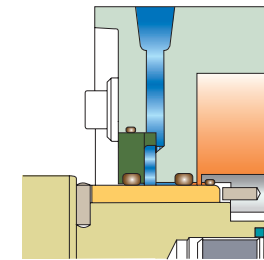

Double O-ring Seal

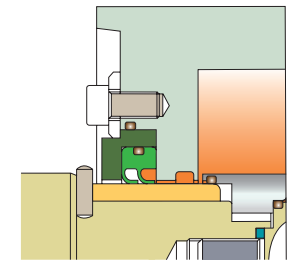

Lip Seal



Our pride is created by high quality!

JEC Sanitary Pumps