

Electric Submersible Sewage Pumps
Ranges K, KX



Discharge Size
DN 200 up to DN 500

motralec

4 rue Lavoisier . ZA Lavoisier . 95223 HERBLAY CEDEX
Tel. : 01.39.97.65.10 / Fax. : 01.39.97.68.48
Demande de prix / e-mail : service-commercial@motralec.com

www.motralec.com

Innovation in Hydraulic Performance

High Performance in Waste Water Pumping

HOMA submersible waste water and sewage pumps operate worldwide in numerous kinds of domestic, municipal and industrial applications. Decades of experience in the design and manufacturing of submersible pumps plus uncompromising attention to quality in every detail and strict monitoring of production quality ensure the utmost reliability and long service life of all **HOMA** products.



Flexible system-components for problem-free installation

HOMA combines efficiency, safety, high quality and robust design with a flexibility that allows the individual optimization of every project realization:

Pumps for various types of application and installation, a complete program of installation equipment including pipes, valves, pump pits from concrete or composite materials, electric control and monitoring systems. With this range HOMA can provide a tailor-made solution for every waste water pumping application.



The reliability of fully automatic operation

HOMA waste water pumping stations feature fully automatic control and monitoring. Reliable liquid level control systems of various types (float switch, pneumatic, ultrasound or electronic systems) are available to secure reliable pump operation at minimum energy consumption. All possible fault factors like shaft seal condition, temperatures, moisture or power supply can be automatically monitored and transferred to various alarm systems.

Higher Performance to meet every Challenge

Various challenges – individual solutions: **HOMA** submersible wastewater pumps are designed for pumping sewage, sludge, effluents or surface water, including liquids containing a large proportion of solid or fibrous matter. They are installed in domestic, municipal, industrial and agricultural pumping applications.

For chemically aggressive liquids, specific components like impellers, volutes or complete units are also available from high-resistant materials like stainless steel, duplex or bronze.



The right installation for every pump station

Wet well installation with auto-coupling system

Submerged autocoupling guide tube system for automatic connection and disconnection of the pump from the pipework from outside the sump. All maintenance or repair work can be done outside the sump. Back in operating position, the weight of the pump ensures leak-proof discharge connection.

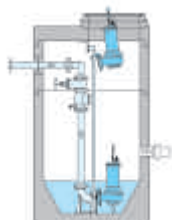

Wet well installation with base stand

Submerged pump mounted on a ring base stand for temporary, service or emergency operation. Discharge connection with pipe or hose.

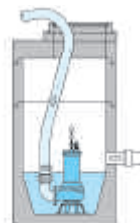

Permanent dry well installation, vertical or horizontal

Flood-proof installation for pump stations with separate collection sump. Fixed flanged connection of suction and discharge pipe.

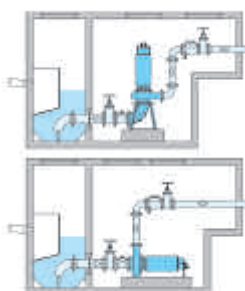

Operating conditions

The motors are designed for continuous operating duty (S1) at maximum 15 starts per hour. In addition to a fully submerged motor housing in wet well installation, a jacket cooled motor-variant is available for S1 operating with a non-fully submerged motor or for dry well installation.

Pumps with enclosed two-channel impellers are designed for intermittent operation, normally in automatic level-controlled wet or dry well sump installations. They are also suitable for limited continuous operation, as in storm water retention tanks, or for unlimited continuous operation, such as industrial water supply.

Ranges and Models

Motor selection

Motor speed:

For the standard hydraulic ranges, the motors are designed with the following speeds:

- 1470 rpm = 4-pole
- 960 rpm = 6-pole
- 720 rpm = 8-pole
- 590 rpm = 10-pole
- 490 rpm = 12-pole

Voltages:

All specified data relate to an operating voltage of 400 V/3 Ph, 50 Hz. Different voltages are available on request.

Type of starting:

The motors are supplied as standard suitable for Direct- or Star-Delta-Start. All motors are also suitable for operating with frequency converter or soft starter device.

Explosion protection:

In addition to the standard version, all motors are available explosion proof according to ATEX Ex II 2 G EEXd.

Dry well variant:

Besides the version for submerged operation, all pumps are also available for dry well or non-submerged operation. Motor cooling is provided by a cooling jacket, using either the pumped liquid or external coolant circulation.

Motor monitoring:

All motors are supplied with temperature sensors in the winding, bi-metallic sensors (standard) or PTC sensors or PT 100 (on request).

- Motors for wet well installation (without cooling jacket):
As C-version (see pump type code) with oil chamber seal condition monitoring probe and moisture sensor in junction chamber)
- Motors with cooling jacket:
Supplied as standard with oil chamber seal condition monitoring probe.
S-version additionally with moisture monitoring in the stator housing.
Additional monitoring devices (e. g. bearing temperature) on request.

Hydraulic selection

Discharge and suction flange:

- DN 200
- DN 250
- DN 300
- DN 400
- DN 500

Reducing adapters for different auto-coupling system and valve dimensions are available.

Enclosed two channel impeller

For liquids containing impurities and sludge with solid particles.



Impeller spherical clearance:

The pumps are available with impeller spherical clearances from 100 mm to 200 mm according to pump range.

Pump type code:

Pump	4		80 -	Motor	(U)	26	4	(C)	(S)	(EX)
K(X)	4	4	80 -	H	(U)	26	4	(C)	(S)	(EX)
Impeller design:	Discharge size:	Spherical clearance:	Impeller diameter:	Motor frame size:	Jacket cooled:	Motor power (coded)	Speed:	only for motors without jacket cooling	Moisture monitoring in the stator housing	Explosion proof motor
K, KX = Enclosed two channel	4 = 200 mm 5 = 250 mm 6 = 300 mm 8 = 400 mm 10 = 500 mm	4 = 100 mm 5 = 130 mm 6 = 150 mm 8 = 165 mm 8 = 200 mm	(mm : 5) e. g. 80 = 400 mm	F, G, H, R, S	Jacket cooled motor for non-submerged installation U = open circuit pumped cooling L = closed circuit liquid cooling		4 = 4-pole (1470 rpm) 6 = 6-pole (960 rpm) 8 = 8-pole (720 rpm) 10 = 10-pole (590 rpm) 12 = 12-pole (490 rpm)			

Design – Proven Quality in Detail

More quality in design and materials – less maintenance and failures

Quality can be measured – **HOMA** submersible waste water pumps are characterized by the robust design, generous dimensioning and high quality materials of all components.

Materials

Motor housing	Cast iron GG25/EN-GJL-250 ¹⁾
Pump housing	Cast iron GG25/EN-GJL-250 ¹⁾
	Cast iron GGG40/EN-GJS-400-15
Impeller	Cast iron GG25/EN-GJL-250 ¹⁾
	Cast iron GGG40/EN-GJS-400-15
Wear rings	Bronze / Stainless Steel
Motor shaft	Stainless steel
Mechanical seals	Silicon-carbide / Silicon-carbide
Motor cooling jacket (model U)	Stainless steel
Seals and O-rings	NBR (Perbonane) ³⁾
Cable	H07RN-F (PLUS) ⁴⁾

¹⁾ also available in stainless steel

²⁾ also available in bronze

³⁾ also available from FPM (vitone)

⁴⁾ screened cable on request

1 Discharge

With DIN/ANSI flange DN 200 up to DN 500 (PN 10)

2 Non-clogging, high efficiency impellers

Enclosed two channel impeller with replaceable wear ring and large spherical clearance.

3 Shaft seals

Two independently working silicon-carbide mechanical seals in tandem-arrangement.

4 Oil chamber

Separate large oil chamber, lubricating and cooling the mechanical seals, forming an extra safety and inspection element. Additional electronic seal condition monitoring probe.

5 Motor

Three-phase electric motors, with 4-, 6-, 8-, 10- or 12-pole motor speed. Insulation class F (155 °C), degree of protection IP 68

Explosion protection

All models available with explosion proof motors according to ATEX Ex II 2 G EExd.

6 Motor cooling

Motors for submerged operation are cooled by the surrounding liquid. For dry well or non-submerged operation, motors are available with a cooling jacket, providing a cooling circulation of water from the pump volute (model U). Alternatively, a closed circuit liquid cooling system is available without directly using the pumped liquid for the cooling circuit, providing the heat exchange through a contact surface between heat exchange chamber and pump chamber.

7 Thermal sensor (bi-metal)

Embedded in the motor winding. PTC sensors or PT 100 available on request.

8 Moisture monitoring in stator housing

Separate chamber with float monitoring.

9 Shaft bearing

Maintenance-free, prelubricated ball bearings.

10 Temperature monitoring of the shaft bearings

Available on request.

11 Cable junction chamber

Separate junction chamber

12 Electronic moisture sensor in junction chamber

13 Pressure sealed, strain relief cable entry

14 Anti-condensation heating for cable junction chamber and stator housing available on request

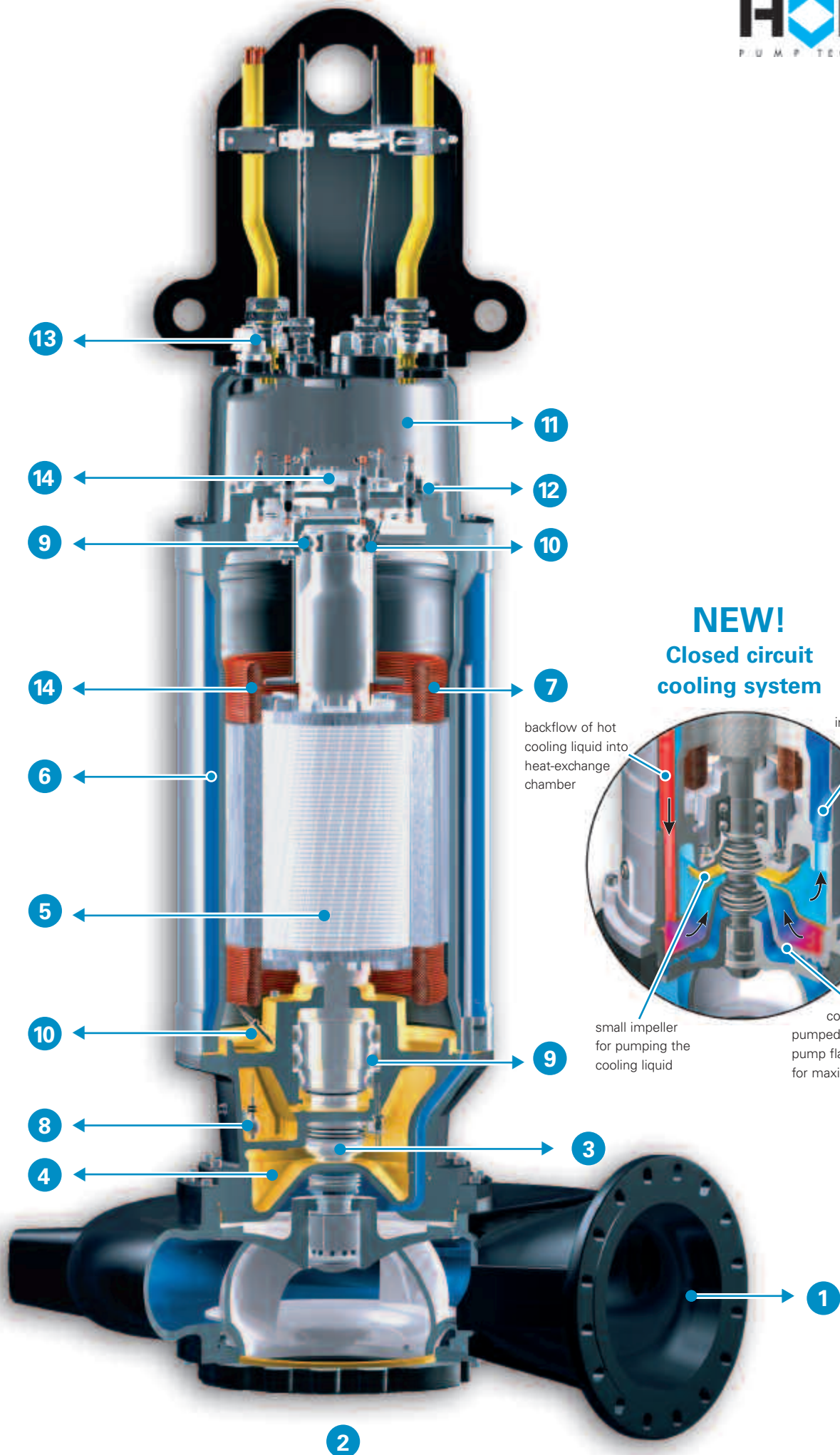

NEW!
Closed circuit cooling system

backflow of hot cooling liquid into heat-exchange chamber

inflow of cold cooling liquid into motor jacket chamber

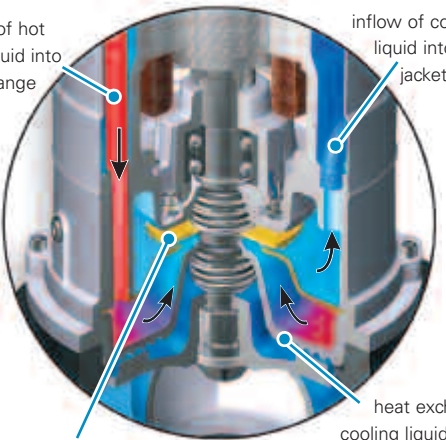

small impeller for pumping the cooling liquid

heat exchange of cooling liquid with cold pumped liquid through pump flange, spiral-shaped for maximum surface

DN500

KX 108... 8-pole



Enclosed two channel impeller
200 mm Ø
Spherical clearance
740 rpm
[see page 18](#)

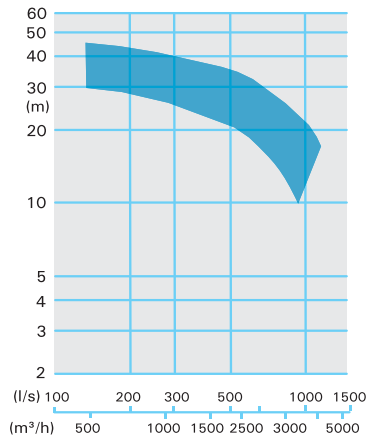

DN500

KX 108... 10-pole



Enclosed two channel impeller
200 mm Ø
Spherical clearance
590 rpm
[see page 19](#)

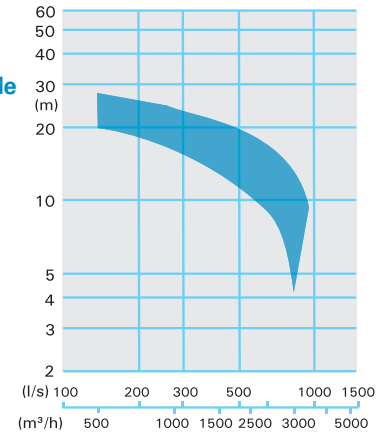

DN500

KX 108... 12-pole



Enclosed two channel impeller
200 mm Ø
Spherical clearance
490 rpm
[see page 20](#)

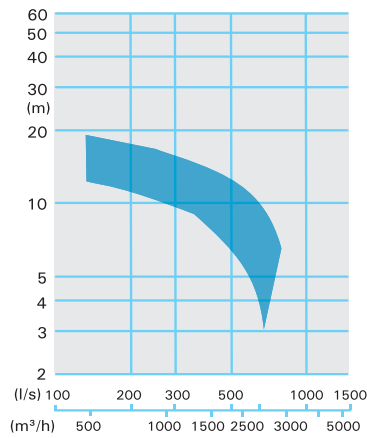

DN500 - KX108... 8-pole



Enclosed two channel impeller

200 mm Ø

Spherical clearance

740 rpm

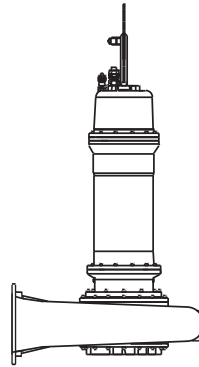

Performance curves

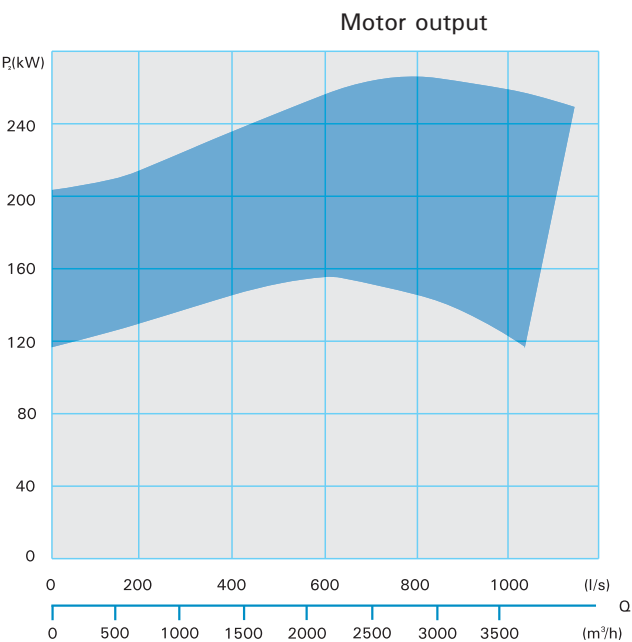
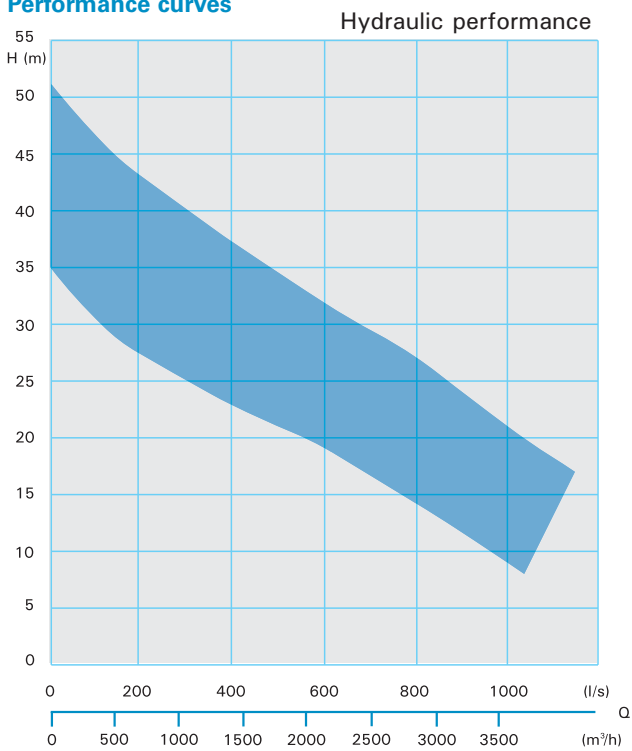

Technical data

Standard- and Explosion-proof model – Wet well installation

Curve No.	Pump type	Motor input P ₁ (kW)	Motor output P ₂ (kW)	Rated current I _n (A)	Weight standard (kg)
Technical information of separate pump types on request!					

Technical information of separate pump types on request!



Enclosed two channel impeller

200 mm Ø
Spherical clearance
590 rpm

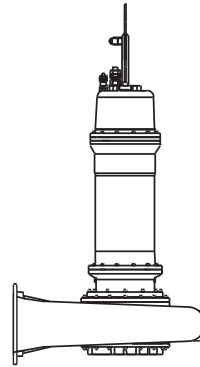

Performance curves

Hydraulic performance

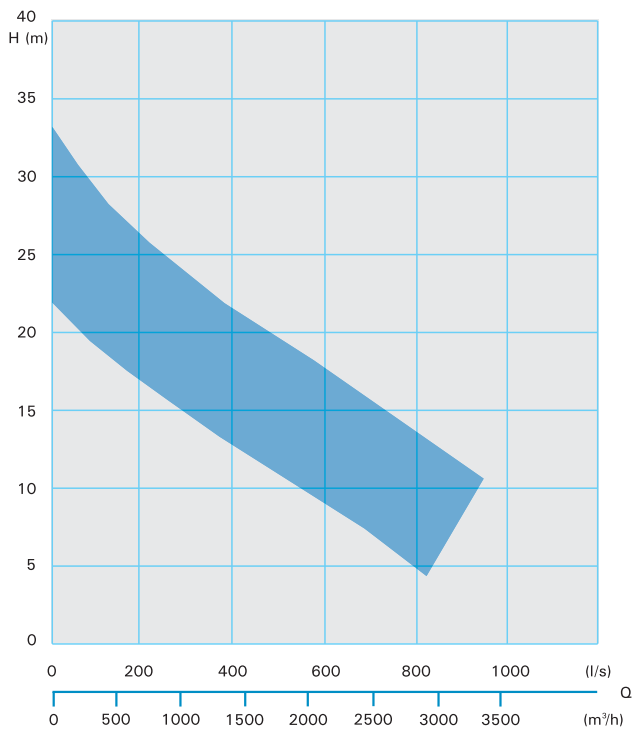

Motor output

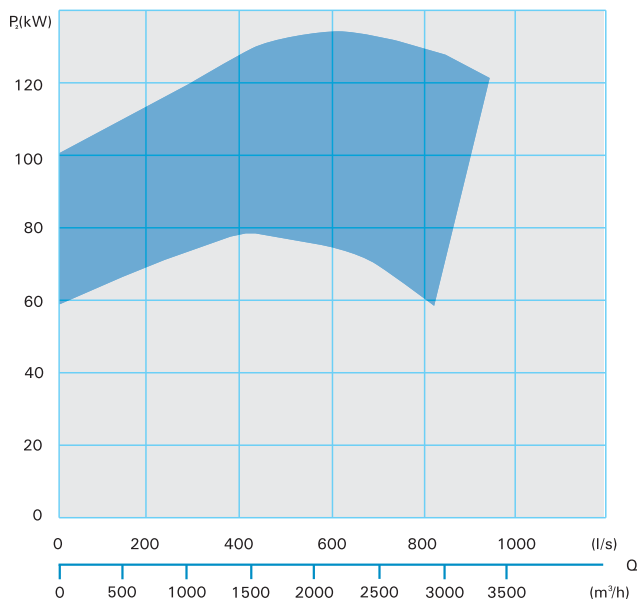

Technical data

Standard- and Explosion-proof model – Wet well installation

Curve No.	Pump type	Motor input P ₁ (kW)	Motor output P ₂ (kW)	Rated current I _N (A)	Weight standard (kg)
Technical information of separate pump types on request!					

Technical information of separate pump types on request!

DN500 - KX108... 12-pole



Enclosed two channel impeller

200 mm Ø

Spherical clearance

490 rpm

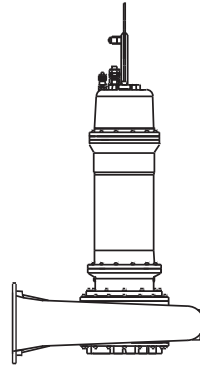

Performance curves

Hydraulic performance

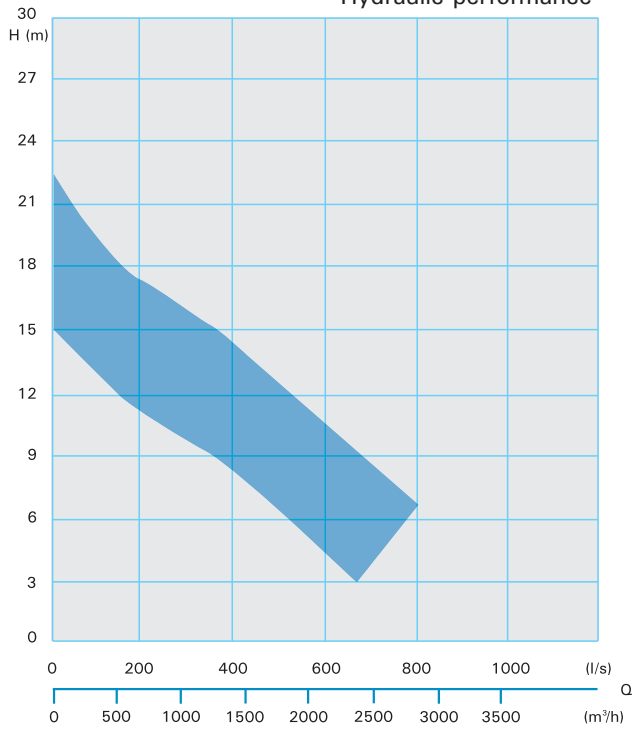

Motor output

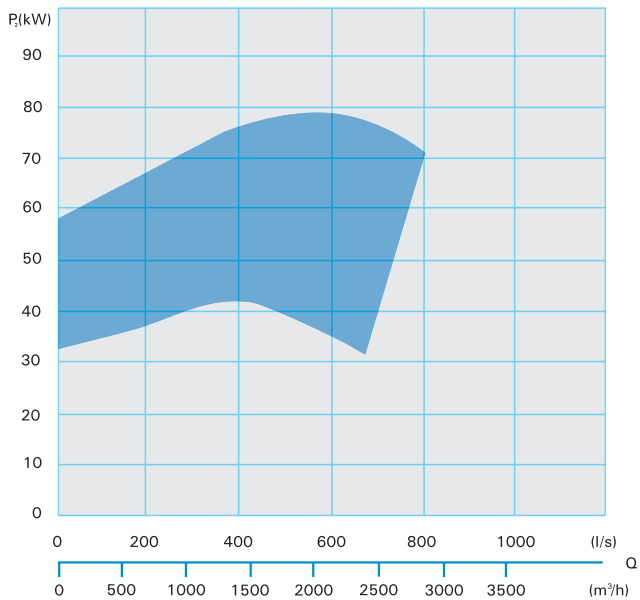

Technical data

Standard- and Explosion-proof model – Wet well installation

Curve No.	Pump type	Motor input P ₁ (kW)	Motor output P ₂ (kW)	Rated current I _N (A)	Weight standard (kg)

Technical information of separate pump types on request!

Permanent wet well installation with autocoupling system

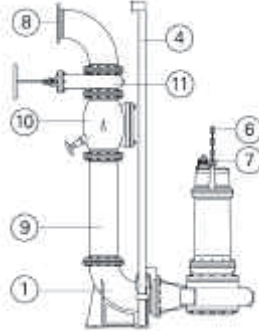

Transportable wet well installation

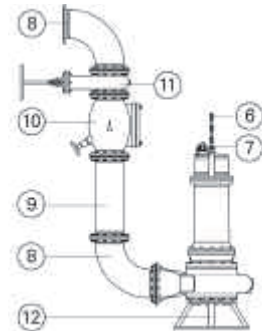

Permanent dry well installation vertical

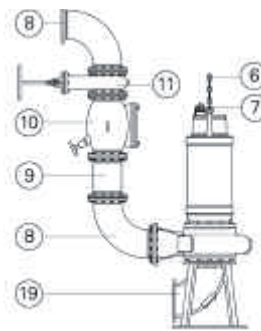

Permanent dry well installation horizontal

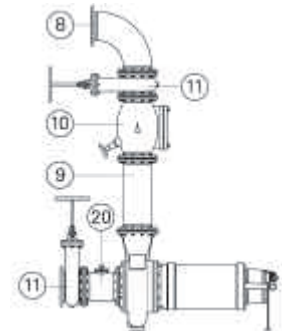

No.	Description	Type	Dimension	Part No.
1	Auto-coupling system, cast iron, consisting of auto-coupling with flanged elbow, flanged pump coupling and upper slide rail bracket	KK 200/200	DN200	8604100
		KK 250/200	DN250/200	8604120
		KK 250/250	DN250	8604110
		KK 300/250	DN300/250	8604130
		KK 300/300	DN300	8604090
		KK 400/350	DN400/350	8604144
KK 400/400	DN400	8604140		
2	Auto-coupling system, consisting of auto-coupling with horizontal discharge flange, flanged pump coupling and upper slide rail bracket	KS 200/200	DN200	8604081
		KS 250/250	DN250	8604085
4	Guide rails, pair, per meter - Galvanized steel		2"	2190205
			2½"	2190225
			3"	2190230
			2"	2190256
			2½"	2190258
			3"	2190260
6	Lifting chain, per meter - Galvanized steel - Stainless steel			on request
				on request
7	Shackle - Galvanized steel - Stainless steel			on request
				on request
8	90° steel elbow with 2 flanges, gasket and fixing bolts		DN200	2153363
			DN250	2153373
			DN300	2153383
			DN400	on request
	90° cast iron elbow with cleaning hole and 2 flanges, gasket and fixing bolts		DN200	on request
			DN200/250	on request
			DN250/300	on request
			DN300 DN400	on request
	Flanged Y-piece for twin pump arrangement, gasket and fixing bolts		DN200 DN250 DN300 DN400	on request

No.	Description	Type	Dimension	Part No.
9	Flanged discharge pipe, 1 meter, with gasket and fixing bolts		DN200	2150200
			DN250	2150250
			DN300	2150300
			DN400	on request
	Discharge pipe, per additional meter			on request
	Flanged reducer			on request
10	Flanged swing check valve, cast iron		DN200	2212816
			DN250	2216817
			DN300	2216300
			DN350	on request
			DN400	on request
11	Flanged gate valve, cast iron		DN200	2216200
			DN250	2216250
			DN300	2216300
			DN400	on request
12	Ring base stand	NB200	DN200	7321295
		NB250	DN250	7321675
		NB350	DN350	on request
19	Pump stand for vertical dry well installation on concrete base with 90° suction elbow and cleaning hole (DN200-DN250)	TVS200 R	DN200	8604240
		TVS200/250 R	DN200/250	8604245
		TVS250 R	DN250	8604250
		TVS250/300 R	DN250/300	8604255
		TVS350	DN350	8604265
	Mounting plate for vertical dry well installation on concrete base with 90° suction elbow	TVM400	DN400	on request
20	Flanged pipe with cleaning hole, gasket and fixing bolts		DN200	2159820
			DN250	2159825
			DN350	on request
			DN400	on request

Stainless steel coupling systems, elbows, pipes, fittings (valves, flaps etc.) on request.

Electrical or electronic **control panels** for pumps and pump stations with accessories on request.

Sumps of concrete or synthetic material for complete pump stations please see special leaflet.

Pump housing with cleaning hole on request.

Accessories DN500 on request.

Installations and Dimensions

Pump type	DN1	DN2	DN2*	DN3	Amax	B	B1	C	C1	D	E	F1	F2	F3	øG	H	J1
KX44(68-80)-G(U)... 4(Ex)	200	200	250	200	1518	878	550	650	291	1552	160	250	400	767	600	1417	369
KX44(76-83)-H(U)... 4(Ex)	200	200	250	200	1673	878	550	650	291	1552	160	250	400	767	600	1417	369
KX44(68-83)-F(U)... 6(Ex)	200	200	250	200	1333	878	550	650	291	1552	160	250	400	767	600	1417	369
KX4483-G(U)136(Ex)	200	200	250	200	1388	878	550	650	291	1552	160	250	400	767	600	1417	369
KX44(85-92)-H(U)... 4(Ex)	200	250	300	200	1695	1000	600	779	353	1674	138	250	422	789	800	1539	369
KX44(85-92)-G(U)... 6(Ex)	200	250	300	200	1535	1000	600	779	353	1674	138	250	422	789	800	1539	369
K55(64-76)-F(U)... 6(Ex)	250	250	300	250	1363	892	530	741	320	1681	155	250	420	869	800	1577	449
K55(74-76)-G(U)... 6(Ex)	250	250	300	250	1418	892	530	741	320	1681	155	250	420	869	800	1577	449
K55(64-76)-F(U)... 8(Ex)	250	250	300	250	1363	892	530	741	320	1681	155	250	420	869	800	1577	449
KX66(78-86)-G(U)... 6(Ex)	300	350	-	300	1593	1100	630	915	386	1946	145	300	505	1030	1000	1880	527
KX66(89-95)-H(U)... 6(Ex)	300	350	-	300	1773	1100	630	915	386	1946	145	300	505	1030	1000	1880	527
KX66(80-95)-G(U)... 8(Ex)	300	350	-	300	1593	1100	630	915	386	1946	145	300	505	1030	1000	1880	527
KX86(100-102)-H(U)... 6(Ex)	400	400	-	400	1811	1500	880	1215	512	2702	167	-	-	-	-	-	-
KX86(104-110)-R(U)... 6(Ex)	400	400	-	400	2894	1500	880	1215	512	2702	167	-	-	-	-	-	-
KX86(100-110)-H(U)... 8(Ex)	400	400	-	400	1661	1500	880	1215	512	2702	167	-	-	-	-	-	-
KX108...	500	on request															

* Vertical dry well installation (see accessories)

Wet well installation with auto-coupling system

DN200

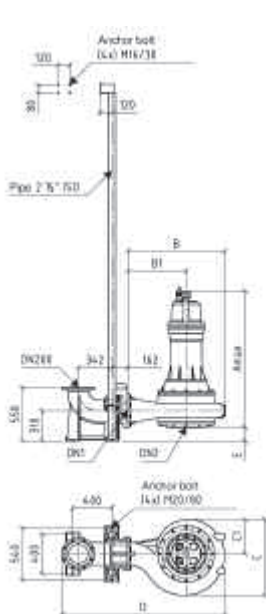

DN250

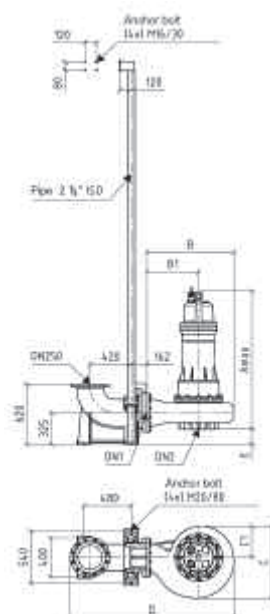

DN300

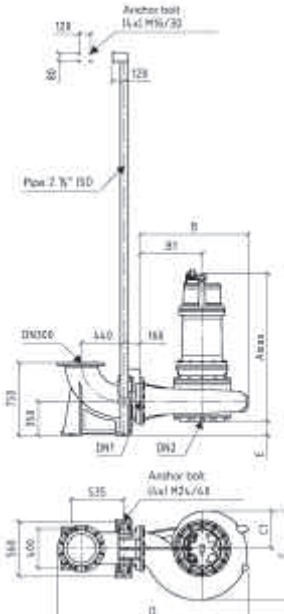

DN400

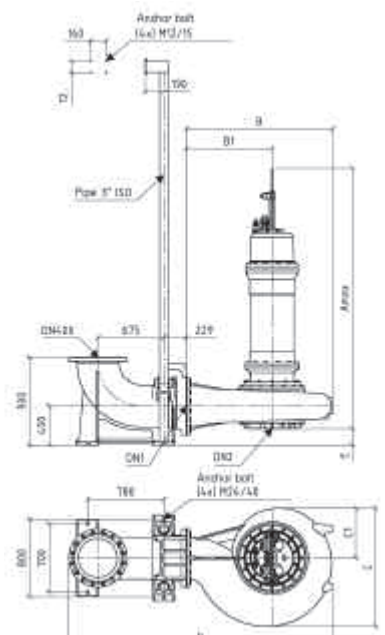

J2	K1	K1*	K2	K3	K4	L	MxM	O	P1	P2	Q	Rmax	S1	S3	Tmax	Umax	V1
369	301	301	692	842	1209	367	560x560	1417	350	900	150	1533	500	120	1256	1396	410
369	301	301	692	842	1209	367	560x560	1417	350	900	150	1688	500	120	1440	1550	508
369	301	301	692	842	1209	367	560x560	1417	350	900	150	1345	500	120	1118	1228	360
369	301	301	692	842	1209	367	560x560	1417	350	900	150	1403	500	120	1156	1266	410
369	318	298	692	864	1231	350	680x680	1539	430	1030	172	1710	450	120	1440	1550	508
369	318	298	692	864	1231	350	680x680	1539	430	1030	172	1550	450	120	1281	1391	410
449	318	298	692	862	1311	350	680x680	1553	400	930	170	1375	490	125	1128	1248	360
449	318	298	692	862	1311	350	680x680	1553	400	930	170	1250	490	125	1003	1123	360
449	318	298	692	862	1311	350	680x680	1553	400	930	170	1375	490	125	1128	1248	360
527	377	-	1002	1207	1732	602	900x900	1880	500	1130	205	1608	500	120	1306	1416	410
527	377	-	1002	1207	1732	602	900x900	1880	500	1130	205	1788	500	120	1486	1596	508
527	377	-	1002	1207	1732	602	900x900	1880	500	1130	205	1608	500	120	1306	1416	410
684	400	-	1111	1344	2025	682	-	2466	650	1530	233	1826	740	140	1496	1616	508
684	400	-	1111	1344	2025	682	-	2466	650	1530	233	2293	740	140	2021	2161	740
684	400	-	1111	1344	2025	682	-	2466	650	1530	233	1676	740	140	1346	1466	508

Wet well installation with base stand only
KX44
K55
KX66

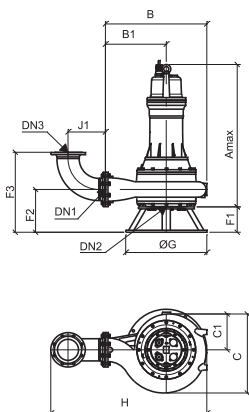

Dry well installation vertical with base stand only
KX44
K55
KX66

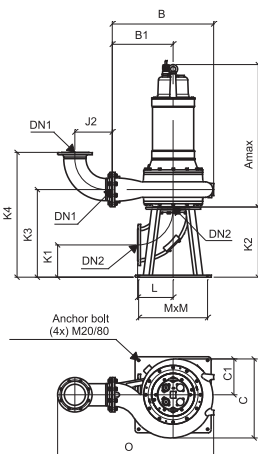

Dry well installation vertical with concrete base only
KX86

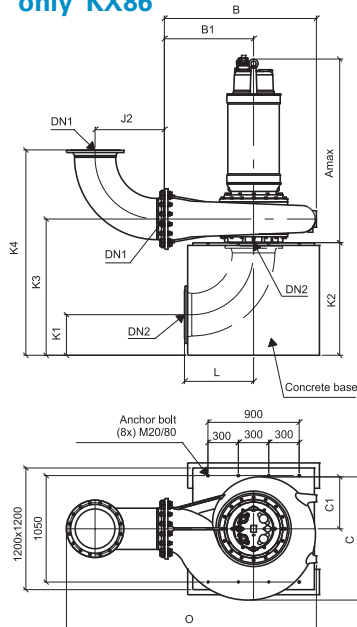

Dry well installation horizontal

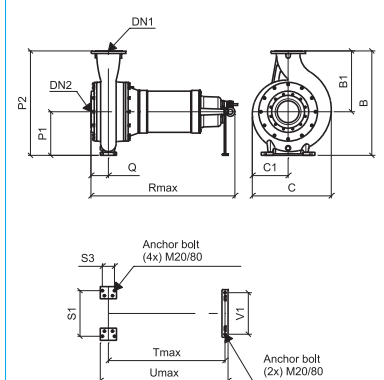

treatment standards. To maintain and further develop this high quality level is our main target.

ation and selection, including a computer software program available on CD-ROM or from the WorldWideWeb.

The source for world wide pump technology

HOMA
P U M P T E C H N O L O G Y



HOMA product range



- Submersible drainage pumps
- Deepwell submersible pumps
- Submersible sewage pumps
- Domestic waste water disposal units
- Compact sewage disposal units
- Packaged pump stations
- Mixers and flow generators
- Injector systems for tank cleaning
- Garden pumps
- Domestic booster units
- Control panels

motralec

4 rue Lavoisier . ZA Lavoisier . 95223 HERBLAY CEDEX
Tel. : 01.39.97.65.10 / Fax. : 01.39.97.68.48
Demande de prix / e-mail : service-commercial@motralec.com

www.motralec.com