

# LC/LCD ranges – level controllers



## Keeping a close eye on liquid levels

### Reliable level controllers from Grundfos

Grundfos offers a choice of level controllers to keep a watchful eye on liquid levels in pump pits, ensuring correct operation and protecting your pumps. The range includes the LC models, designed for single pumps, and the LCD models, designed for two pumps. They are all excellent for both drainage pumps and sewage pumps, making them ideal partners for the Grundfos KP, AP, SEG, S1, SV, SEN, SEV and SE1 pump series.



### Three series – six versions

The Grundfos LC/LCD range of level controllers comprises three series with a total of six versions:

- The LC/LCD 107 level controllers, operated by level bells
- The LC/LCD 108 level controllers, operated by float switches
- The LC/LCD 110 level controllers, operated by electrodes

All of these models are designed specifically for Grundfos pump systems, ensuring a perfect match between the technologies used. They are excellent for applications requiring up to 11 kW direct-on-line start motors. The LC and LCD 108 can also be supplied with an integrated star-delta starter for applications requiring larger motors, up to 30 kW.



## Control panels and monitoring

All LC/LCD level controllers feature a control panel with a switch, enabling easy operation of one or two pumps in manual or automatic mode. The control panel is fitted in a cabinet that meets the requirements for enclosure class IP 55.

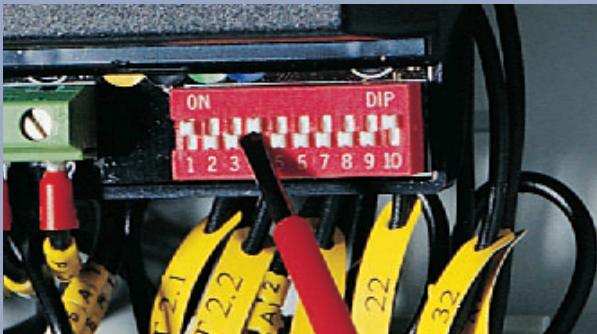

The flexible electronic control units (known as the CU 211/212/213/214, respectively) will handle all inputs and respond in accordance with the controller settings. The control unit features a 10-pole DIP switch which is used to specify the correct system responses to input - such as when to sound an alarm or when to have both pumps operate at the same time. The DIP switch makes it possible to quickly adapt the level controller to current circumstances. It can also enable/disable automatic restart following thermal cut-outs where this is relevant.

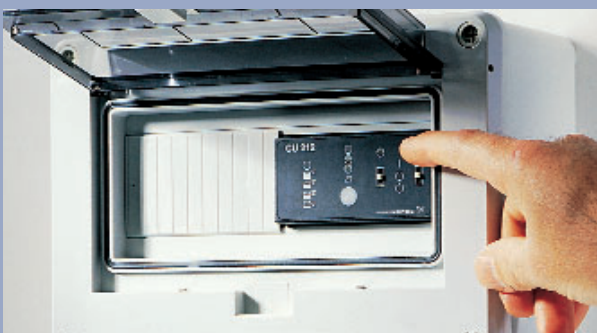

## Modular system

A modular approach allows the Grundfos level controllers to be fitted with extra features such as an hour counter, start counter and/or battery back-up to ensure that an alarm is sounded in the event of power failure, etc. All modules/accessories are easily installed.

## Grundfos level controllers in brief

Listed below are some of the features and benefits of the Grundfos level controllers

- Control one pump (LC) or two (LCD)
- Automatic alternating operation (LCD)
- Automatic test run (prevents shaft seals from becoming jammed in the event of long periods of inactivity)\*
- Water hammer protection
- Battery back-up (available as optional accessory)
- Starting delay after power supply failure (prevents network overload)\*
- Automatic alarm reset (if required)
- Automatic restart (if required)
- Users can set stop delays of up to 180 seconds to suit operating conditions
- Liquid level indication
- High-level alarm
- Motor overload protection relay
- Protection against motor overheating via input to PTC resistor/thermal switch

*\*Requires battery back-up*



## Alarm protection

The Grundfos level controllers will warn you by raising an alarm in the event of:

- Overload
- Dry running
- Excessive temperatures
- Incorrect phase sequences
- Power cut-out
- Failing level input
- Mains supply failure (when fitted with the optional battery back-up)
- Float switch/level bell/electrode failure

# LC/LCD 107

## A level bell solution from Grundfos

The LC 107 (for one pump) and LCD 107 (for two pumps) monitor liquid levels by means of level bells. The 107 level controllers are supplied as complete units, incorporating a motor protection relay, level bells, pneumatic tubes and a control unit mounted inside a waterproof cabinet.

The system responds to pneumatic signals received from level bells positioned in a pump pit. Usually, two level bells are used for single-pump applications and three bells are used for dual pump systems. Grundfos 107 controller systems have potential-free signal outputs for common alarms and high-level alarms. A buzzer in the control unit also provides an audible alarm.





### LC 107

The Grundfos LC 107 level controller is designed for use with a single pump, using a pair of level bells to provide signal input to the control unit. The lower bell sends the input signal that starts the pump, while the upper bell triggers a high-level alarm if the liquid reaches it. It will also start the pump in emergencies if the lower bell should fail. The LC 107 allows users to set a specific operating time, using the DIP switch to specify how long the pump should continue operation after a start signal has been received.

### LCD 107

The LCD 107 level controller is almost identical to the LC 107. The main difference is that the LCD 107 is designed as a two-pump controller using three level bells. The LCD 107 also ensures that the total operating hours are evenly distributed between the two pumps by means of an automatic alternation function.

The lower bell sends the input signal that starts the first pump, and the middle bell sends the signal that starts the second pump in cases where simultaneous pump operation is required. The upper bell acts as a high-level alarm and will also start the pumps in emergencies where the lower bells fail.

### How it works

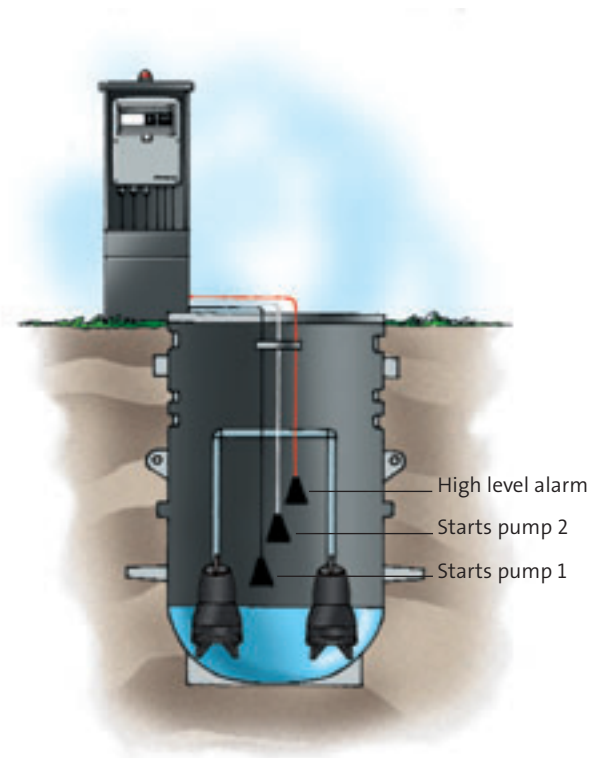

Level bells offer a reliable way of monitoring liquid levels. With this solution, no electronic equipment is installed in the pump pit. Instead, the level bells are connected to pressure switches in the control box by means of tubes. As the liquid rises to a height of approximately three centimetres above the bottom of the level bell, the air inside the bell is compressed, activating the pressure switch in the control box. This sends a signal to either start the pump or give warning by means of the system alarms. The simplicity of the solution also has the added benefit of making level bells highly suitable for use in potentially explosive atmospheres.



### Design features

Grundfos level bells are made from cast iron. This makes them heavy enough to maintain the correct position in the pump pit. They are suitable for applications where the liquid pumped has a pH value of 4 to 10.

## Controller type, electrical data and product numbers

Level controller	Description	Operating current per pump [A]	Mains switch required [A]	Product number			
				Grundfos product no.	Hour counter available*	Start counter available*	Combined hour and start counter available*
	LC 107 controller, pneumatic version with level bells and tube for 1 pump 1 x 230 V, direct-on-line starting. With built-in start and operating capacitors (150/30 µF) for SEG pumps.	3.7 – 12.0	25	96 10 49 02	Yes	Yes	Yes
	LC 107 controller, pneumatic version with level bells and tube for 1 pump 1 x 230 V, direct-on-line starting.	1.0 – 2.9	25	96 00 24 64	Yes	Yes	Yes
		1.6 – 5.0	25	96 00 24 65	Yes	Yes	Yes
		3.7 – 12.0	25	96 00 24 66	Yes	Yes	Yes
	LC 107 controller, pneumatic version with level bells and tube for 1 pump 3 x 400 V, direct-on-line starting.	1.0 – 2.9	25	96 00 24 67	Yes	Yes	Yes
		1.6 – 5.0	25	96 00 24 68	Yes	Yes	Yes
		3.7 – 12.0	25	96 00 24 69	Yes	Yes	Yes
12.0 – 23.0		40	96 00 24 70	Yes	Yes	Yes	
	LCD 107 controller, pneumatic version with level bells and tube for 2 pumps 1 x 230 V, direct-on-line starting. With built-in start and operating capacitors (150/30 µF) for SEG pumps.	3.7 – 12.0	25	96 10 49 03	Yes	Yes	Yes
	LCD 107 controller, pneumatic version with level bells and tube for 2 pumps 1 x 230 V, direct-on-line starting.	1.0 – 2.9	25	96 00 24 71	Yes	Yes	Yes
		1.6 – 5.0	25	96 00 24 72	Yes	Yes	Yes
		3.7 – 12.0	25	96 00 24 73	Yes	Yes	Yes
	LCD 107 controller, pneumatic version with level bells and tube for 2 pumps 3 x 400 V, direct-on-line starting.	1.0 – 2.9	25	96 00 24 74	Yes	Yes	Yes
		1.6 – 5.0	25	96 00 24 75	Yes	Yes	Yes
		3.7 – 12.0	25	96 00 24 76	Yes	Yes	Yes
		12.0 – 23.0	40	96 00 24 77	Yes	Yes	Yes

\* Please see *Accessories* on page 14

### Voltage tolerances

-15% to +10% of nominal voltage

### Mains frequency

50/60 Hz

### Ambient temperature

- During operation: -30°C to +50°C (must not be exposed to direct sunlight)
- In stock: -30°C to +60°C

### Enclosure class

IP 55

### Pneumatic tubes

- Maximum length of tube: 20 m (standard: pneumatic tube of 10 metres)
- Diameter: 10 mm
- Material: PA 11

### Outputs for alarm devices

Max. 400 VAC/ max. 2 A / min. 10 mA / AC 1 (NO, NC to order)

### Supply system earthing

For TN systems and TT systems

### Rated insulation voltage, $U_i$

4 kV

### Rated impulse withstand voltage, $U_{imp}$

4 kV

### EMC (electromagnetic compatibility)

According to EN 61 000-6-2 and EN 61 000-6-3

## Accessories for LC/LCD 107

Picture	Description	Product number
	Black pneumatic tube, 20 metres	96 43 16 14
	Red pneumatic tube, 20 metres	96 43 16 15
	White pneumatic tube, 20 metres	96 43 16 16



## Controllers with float switches

The LC 108 and LCD 108 level controllers are supplied as complete units with a motor protection relay incorporated in the waterproof cabinet. These level controllers are based on on/off signals, allowing them to receive input from up to four float switches positioned in the pump pit. Float switches are sold separately.

Like the other level controllers from Grundfos, the LC and LCD 108 controllers can serve systems requiring up to 11 kW direct-on-line start motors. In addition to this, the 108 controllers are also available with an integrated star-delta starter for applications requiring up to 30 kW motors. Both versions have potential-free signal outputs for common alarms and high-level alarms. A buzzer in the control unit also provides an audible alarm.

# LC/LCD 108

## LC 108

The LC 108 level controller is designed for use with a single pump, responding to signals from float switches. When only one float switch is used to start the pump, you must define the operating time following a stop signal by means of the DIP switches.

## LCD 108

The LCD 108 level controller is designed to control two pumps on the basis of signals from float switches. The LCD 108 can be configured for systems allowing for simultaneous operation of the two pumps (using three or four float switches), as well as for systems with 100 percent spare capacity. The LCD 108 also has an automatic pump alternation function, ensuring that the total operating hours are evenly distributed between the two pumps.

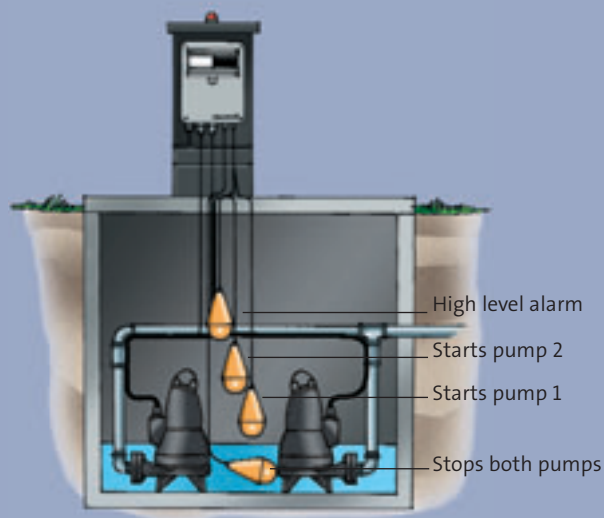





## How it works

A float switch is a very popular way of controlling liquid levels in tanks, pits, etc. A switch, encased in a polypropylene housing, is suspended at the desired height by its own 3-core cable. When the liquid reaches a certain level, the drop-shaped float switch tips over, causing the contact to open or close. This triggers the response determined by you.



## Design features

The Grundfos float switches are of the non-mercury type and are available for standard and explosion-proof pumps. The hermetically sealed polypropylene housing and polyurethane cable makes the float switch resistant to e.g. many chemicals, alcohol, uric acid, sewage, oils, petrol and fruit acid.

## Accessories for LC/LCD 108

No.	Accessories		Product number	
	Picture	Description		
1		Float switch with 10 m cable	For LC 108 and LCD 108 controllers	
		Float switch with 20 m cable		96 00 36 95
		Float switch for potentially explosive environments, with 10 m cable	For LC 108 and LCD 108 controllers connected to LC-Ex4	
		Float switch for potentially explosive environments, with 20 m cable		96 00 35 36
2		Bracket for float switch	96 00 33 38	
3		1 pump without alarm (2 switches)	62 50 00 13	
		1 pump with alarm (3 switches)	62 50 00 14	
		2 pumps without alarm (3 switches)	62 50 00 14	
		2 pumps with alarm (4 switches)	62 50 00 15	
4		Float switches for potentially explosive environments, w/10 m cable and bracket. One switch is always used for dry-running protection in explosion-proof applications	1 pump without alarm (3 switches)	62 50 00 17
		1 pump with alarm (4 switches)	62 50 00 18	
		2 pumps without alarm (4 switches)	62 50 00 18	
5		LC-Ex4 safety barrier for potentially explosive float-switch applications. To be used with float switches for potentially explosive applications only. The LC-Ex4 can be mounted in ambient temperatures ranging from -25°C to +50°C. Safety class: II (1) G [EEx ia] II C	96 44 03 00	

## Controller type, electrical data and product numbers

Level controller	Description	Operating current per pump [A]	Mains switch required [A]	Product number			
				Grundfos product no.	With hour counter*	With start counter*	With combined hour and start counter*
	LC 108 controller for float switches for 1 pump 1 x 230 V, direct-on-line starting. With built-in start and operating capacitors (150/30 µF) for SEG pumps.	3.7 – 12.0	25	96 10 49 14			
	LC 108 controller for float switches for 1 pump 1 x 230 V, direct-on-line starting.	1.0 – 2.9	25	96 43 39 56	96 43 39 57	96 43 39 58	96 43 39 59
		1.6 – 5.0	25	96 43 39 61	96 43 39 60	96 43 39 62	96 43 39 63
		3.7 – 12.0	25	96 43 39 64	96 43 39 65	96 43 39 66	96 43 39 67
		12.0 – 23.0	40	96 43 39 71	96 43 39 72	96 43 39 73	96 43 39 74
	LC 108 controller for float switches for 1 pump 3 x 230 V, direct-on-line starting.	1.0 – 2.9	25	96 43 39 75	96 43 39 76	96 43 39 77	96 43 39 78
		1.6 – 5.0	25	96 43 39 79	96 43 39 80	96 43 39 81	96 43 39 82
		3.7 – 12.0	25	96 43 39 83	96 43 39 84	96 43 39 85	96 43 39 86
		12.0 – 23.0	40	96 43 39 87	96 43 39 88	96 43 39 89	96 43 39 90
	LC 108 controller for float switches for 1 pump 3 x 400 V, direct-on-line starting.	1.0 – 2.9	25	96 43 39 91	96 43 39 92	96 43 39 93	96 43 39 94
		1.6 – 5.0	25	96 43 39 95	96 43 39 96	96 43 39 97	96 43 39 98
		3.7 – 12.0	25	96 43 39 99	96 43 40 00	96 43 40 01	96 43 40 02
		12.0 – 23.0	40	96 43 40 03	96 43 40 04	96 43 40 05	96 43 40 06
	LC 108 controller for float switches for 1 pump 3 x 400 V, star-delta starting.	6.4 – 20.0	25	96 43 79 28			
		20.8 – 30.0	40	96 43 79 50			
		20.8 – 59.0	80	96 43 79 70			
		24.2 – 72.0	**	96 43 79 90			
		LCD 108 controller for float switches for 2 pumps 1 x 230 V, direct-on-line starting. With built-in start and operating capacitors (150/30 µF) for SEG pumps.	3.7 – 12.0	25	96 10 49 34		
LCD 108 controller for float switches for 2 pumps 3 x 230 V, direct-on-line starting.		1.0 – 2.9	25	96 43 40 23	96 43 40 24	96 43 40 25	96 43 40 26
		1.6 – 5.0	25	96 43 40 27	96 43 40 28	96 43 40 29	96 43 40 30
		3.7 – 12.0	25	96 43 40 31	96 43 40 32	96 43 40 33	96 43 40 34
		12.0 – 23.0	40	96 43 40 35	96 43 40 36	96 43 40 37	96 43 40 38
LCD 108 controller for float switches for 2 pumps 3 x 400 V, direct-on-line starting.		1.0 – 2.9	25	96 43 40 39	96 43 40 40	96 43 40 41	96 43 40 42
		1.6 – 5.0	25	96 43 40 43	96 43 40 44	96 43 40 45	96 43 40 46
		3.7 – 12.0	25	96 43 40 47	96 43 40 48	96 43 40 49	96 43 40 50
		12.0 – 23.0	40	96 43 40 51	96 43 40 52	96 43 40 53	96 43 40 54
LCD 108 controller for float switches for 2 pumps 3 x 400 V, star-delta starting.		6.4 – 20.0	25	96 43 80 32			
		20.8 – 30.0	40	96 43 80 52			
		20.8 – 59.0	80	96 43 80 72			
		24.2 – 72.0	**	96 43 80 92			

\* Please see *Accessories* on page 14

\*\* Depends on local standards

### Voltage tolerances

-15% to +10% of nominal voltage

### Mains frequency

50/60 Hz

### Ambient temperature

- During operation: -30°C to +50°C (must not be exposed to direct sunlight)
- In stock: -30°C to +60°C

### Enclosure class

IP 55

### Outputs for alarm devices

Max. 400 VAC / max. 2 A / min. 10 mA / AC1 (NO, NC to order)

### Supply system earthing

For TN systems and TT systems

### Rated insulation voltage, $U_i$

4 kV

### Rated impulse withstand voltage, $U_{imp}$

4 kV

### EMC (electromagnetic compatibility)

According to EN 61 000-6-2 and EN 61 000-6-3

# LC/LCD 110

## Monitoring liquid levels with electrodes

The LC 110 and LCD 110 are supplied as complete level controllers contained within a waterproof cabinet. These level controllers respond to signals from electrodes (sold separately). As they work by means of electronic signals, the LC/LCD 110 can receive input from up to five electrodes located in a pump pit.

## LC 110

The LC 110 level controller is designed for level control, monitoring and protection of single pumps in wastewater, water supply and drainage systems. It can be configured with a basic start and stop function (three electrodes), with an added alarm function (four electrodes), or with added dry-running protection (five electrodes).



## LCD 110

The LCD 110 level controller is designed for level control, monitoring and protection of pairs of pumps in wastewater, water supply and drainage systems. It can be configured with basic stop, start 1, and start 2 functions (four electrodes) or with additional alarm functions (five electrodes), for simultaneous operation of both pumps, and more.

The LCD 110 also has an automatic pump alternation function, ensuring that the total operating hours are evenly distributed between the two pumps.

### Design features

The electrodes are made of stainless steel (DIN 1.4401) with polyethylene insulation. They are set inside a nylon housing with an R 1½ thread, and are delivered with 10 m cable as standard. The electrodes are sold separately and must be adjusted onsite to suit the application.

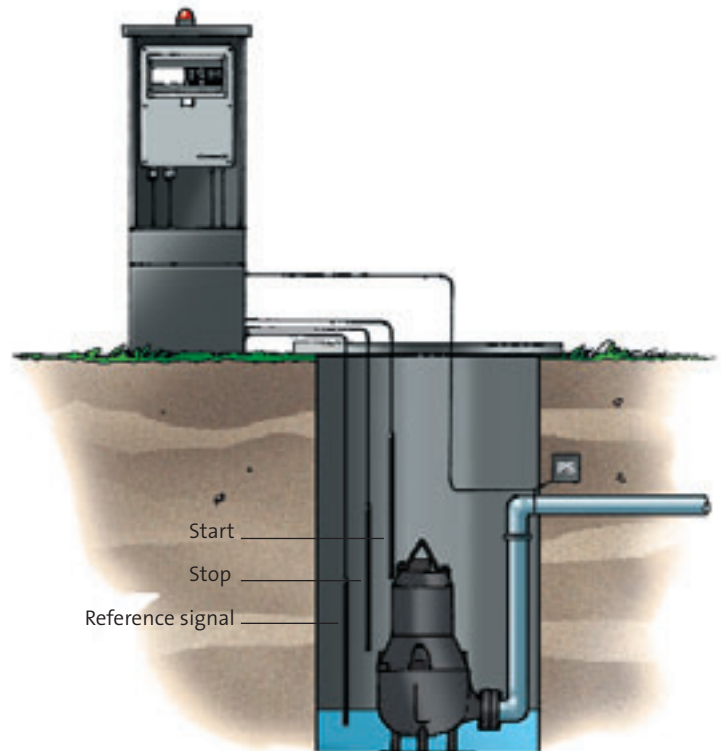

The excellent chemical and thermal properties of the electrodes allow them to be used in a wide range of applications. Electrodes are particularly recommended for narrow pits where larger alternatives may become stuck.



### How it works

Electrodes offer a highly reliable solution to liquid level monitoring in pump pits, even where space is very limited. Electrodes are suspended at appropriate heights, triggering specific responses as the liquid reaches them. This operating principle requires a reference signal, which means that the controller is connected to a conductive material that touches the liquid. This is usually an electrode, but other materials can be used as well.

## Controller type, electrical data and product numbers

Level controller	Description	Operating current per pump [A]	Mains switch required [A]	Product number						
				Grundfos product no.	With hour counter*	With combined hour and start counter*	With battery*	With hour counter and battery*	With combined hour and start counter and battery*	
	LC 110 controller for electrodes for 1 pump 1 x 230 V, direct-on-line starting. Built-in start and operating capacitors (150/30 µF) for SEG pumps.	3.7 – 12.0	25	96 10 49 45						
	LC 110 controller for electrodes for 1 pump 1 x 230 V, direct-on-line starting.	1.0 – 2.9	25	96 48 40 97	96 48 37 03	96 48 37 19	96 48 36 07	96 48 37 74	96 48 37 91	
		1.6 – 5.0	25	96 48 40 98	96 48 37 04	96 48 37 20	96 48 36 09	96 48 37 75	96 48 37 92	
		3.7 – 12.0	25	96 48 40 99	96 48 37 05	96 48 37 21	96 48 37 60	96 48 37 76	96 48 37 93	
		12.0 – 23.0	40	96 48 41 00	96 48 37 06	96 48 37 22	96 48 37 61	96 48 37 77	96 48 37 94	
	LC 110 controller for electrodes for 1 pump 3 x 400 V, direct-on-line starting.	1.0 – 2.9	25	96 48 41 01	96 48 37 07	96 48 37 23	96 48 37 62	96 48 37 78	96 48 37 95	
		1.6 – 5.0	25	96 48 41 02	96 48 37 08	96 48 37 24	96 48 36 63	96 48 37 79	96 48 37 96	
		3.7 – 12.0	25	96 48 41 03	96 48 37 09	96 48 37 25	96 48 37 64	96 48 37 80	96 48 37 97	
		12.0 – 23.0	40	96 48 41 04	96 48 37 10	96 48 37 26	96 48 37 65	96 48 37 82	96 48 37 98	
		LC 110 controller for electrodes for 2 pumps 1 x 230 V, direct-on-line starting. Built-in start and operating capacitors (150/30 µF) for SEG pumps.	3.7 – 12.0	25	96 10 49 48					
LCD 110 controller for electrodes for 2 pumps 1 x 230 V, direct-on-line starting.		1.0 – 2.9	25	96 48 41 05	96 48 37 11	96 48 37 27	96 48 37 66	96 48 37 83	96 48 37 99	
		1.6 – 5.0	25	96 48 41 06	96 48 37 12	96 48 37 28	96 48 36 67	96 48 37 84	96 48 38 10	
		3.7 – 12.0	25	96 48 41 07	96 48 37 13	96 48 37 29	96 48 37 68	96 48 37 85	96 48 38 11	
		12.0 – 23.0	40	96 48 41 08	96 48 37 14	96 48 37 30	96 48 37 69	96 48 37 86	96 48 38 12	
LCD 110 controller for electrodes for 2 pumps 3 x 400 V, direct-on-line starting.		1.0 – 2.9	25	96 48 41 09	96 48 37 15	96 48 37 31	96 48 37 70	96 48 37 87	96 48 38 13	
		1.6 – 5.0	25	96 48 41 10	96 48 37 16	96 48 37 32	96 48 36 71	96 48 37 88	96 48 38 14	
		3.7 – 12.0	25	96 48 41 11	96 48 37 17	96 48 37 33	96 48 37 72	96 48 37 89	96 48 38 15	
		12.0 – 23.0	40	96 48 41 12	96 48 37 18	96 48 37 34	96 48 37 73	96 48 37 90	96 48 38 16	

\* Please see *Accessories* on page 14

### Voltage tolerances

-15% to +10% of rated voltage

### Mains frequency

50/60 Hz

### Ambient temperature

- During operation: -30°C to +50°C (must not be exposed to direct sunlight)
- In stock: -30°C to +60°C

### Enclosure class

IP 55

### Outputs for alarm devices

Max. 400 VAC / max. 2 A / min. 10 mA / AC1 (NO, NC to order)

### Supply system earthing

For TN systems and TT systems

### Rated insulation voltage, Ui

4 kV



### Rated impulse withstand voltage, Uimp

4 kV

### EMC (electromagnetic compatibility)

According to EN 61 000-6-2 and EN 61 000-6-3

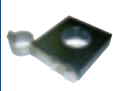
## Accessories for LC/LCD 110

Picture	Description	Product number
	Bracket for electrodes	91 71 31 96
	1 electrode with 10 m cable	96 07 62 89
	3 electrodes with 10 m cable	96 07 61 89
	4 electrodes with 10 m cable	91 71 34 37

# Dimensions

## Dimensions and weights

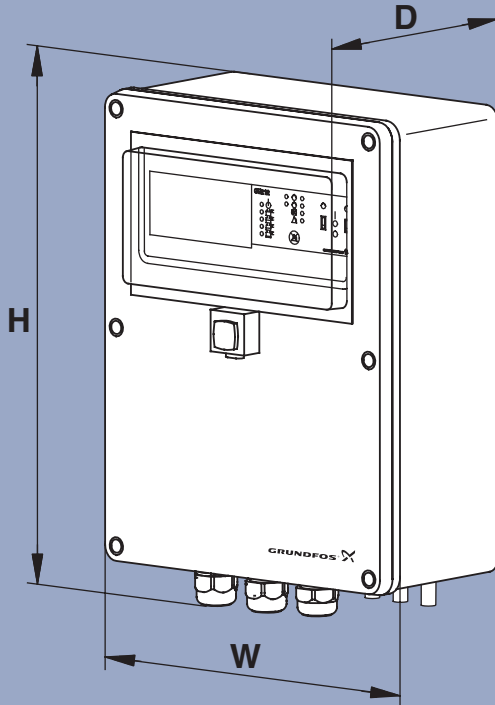

Controller type	Height (mm)	Width (mm)	Depth (mm)	Weight (kg)
LC 107	350	250	136	3
LCD 107	350	250	136	3.6
LC 108	350	250	136	3
LC 108 Y/D	590	380	200	12
LCD 108	350	250	136	3.6
LCD 108 Y/D	635	500	220	32-56
LC 110	350	250	136	3
LCD 110	350	250	136	3.6







## Type key

		Example:	LC	107	230	1	12	30/150	DOL
Controller type	LC =	One-pump controller							
	LCD =	Two-pump controller							
Type of level sensors	107 =	Control of 1 or 2 pumps based on signals from bell shaped level pickups (pneumatic) Max. 11 kW shaft power DOL							
	108 =	Control of 1 or 2 pumps based on signals from float switches or electrodes Max. 11 kW shaft power DOL Max.30 kW shaft power SD							
	110 =	Control of 1 or 2 pumps based on signals from electrodes Max. 11 kW shaft power DOL							
Voltage [V]									
Number of phases	1 =	1 phase							
	3 =	3 phase							
Maximum operating current per pump [A]									
Operating / starting capacitor [ $\mu$ F]									
[ ] = without capacitor									
30 = operating capacitor									
30/150 = 30 $\mu$ F operating and 150 $\mu$ F starting capacitor									
Starting method	DOL =	Direct on-line starting							
	SD =	star-delta starting (only LC 108 and LCD 108)							

Note: Controllers with capacitor are for 12 A operating current.

# Accessories

## Accessories

No.	Accessories			Product number
	Picture	Description		
1		Battery back-up	9.6 V	96 00 25 20
2		Signal lamp, 1 x 230 V	Outdoor mounting	62 50 00 20
3		Acoustic signal (horn), 1 x 230 V	Outdoor mounting	62 50 00 21
			Indoor mounting	62 50 00 22
4		Hour counter	230 V	96 00 25 14
			400 V	96 00 25 15
5		Start counter	230 V	96 00 25 16
			400 V	96 00 25 17
6		Combined hour and start counter	230 V	96 00 25 18
			400 V	96 00 25 19
7		External mains switch for supply cable	25 A	96 00 25 11
			40 A	96 00 25 12
			80 A	96 00 25 13

## Other control units for one pump

No.	Accessories			Product number
	Picture	Description		
1		CU 100 control box for one pump <i>A models include float switch for automatic operation</i>	CU 100.230.1.9.30/150	96 07 62 09
			CU 100.230.1.9.30/150.A	96 07 61 97
			CU 100.230.3.5.A	96 07 61 98
			CU 100.230.3.12.A	96 07 61 99
			CU 100.400.3.2.9.A	96 07 62 00
			CU 100.400.3.5.A	96 07 62 01

# The Grundfos wastewater range

## Heavy-duty submersible sewage pumps 5 – 29 kW

Brochure covers the Grundfos range of submersible channel-impeller pumps from 5 kW up to 21 kW and Super-Vortex pumps up to 29 kW. All designed for handling unscreened raw sewage. Available in 50 Hz and 60 Hz versions.



## Heavy-duty submersible sewage pumps 15 – 155 kW

Brochure covers the Grundfos range of sewage pumps from 15 kW up to 155 kW for handling of raw sewage in heavy-duty applications. Available in 50 Hz and 60 Hz versions.



## Super-heavy-duty submersible sewage and raw water pumps

Brochure covers the Grundfos range of super-heavy-duty channel pumps, axial flow pumps, and propeller pumps from 7.5 kW up to 520 kW.

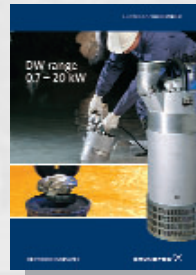

## Portable dewatering pumps

Brochure covers the Grundfos range of portable dewatering pumps (DW) from 0.8 kW to 20 kW for pumping raw water with abrasives.

## The KP/AP stainless steel range

Brochure covers a wide range of high quality stainless steel pumps for a variety of domestic and commercial applications.



## Stainless steel heavy-duty submersible pumps

Brochure covers the Grundfos range of heavy-duty stainless steel pumps (SEN) for aggressive and corrosive environments.



## Lifting stations

Brochure covers Grundfos lifting stations for individual as well as multi-user applications.



## Submersible recirculation pumps

Brochure covers the Grundfos range of SRP submersible recirculation pumps for wastewater treatment plants and flood control.

## Mixers and flowmakers

Brochure covers the new range of mixers and flowmakers for optimal control of liquids and solids throughout the wastewater treatment process.

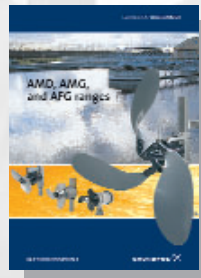

## Submersible sewage grinder pumps

Brochure covers the Grundfos range of sewage grinder pumps (SEG) for pumping of wastewater with toilet discharge.

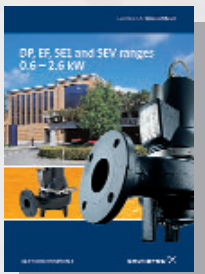

## Heavy-duty submersible wastewater pumps 0.6 – 2.6 kW

Brochure covers the Grundfos range of submersible channel-impeller and Super-Vortex-impeller pumps from 0.6 to 2.6 kW. Designed for handling drainage, effluent and sewage from private dwellings.



## Prefabricated pumping stations

Brochure covers the Grundfos range of prefabricated pumping stations for collecting and removing drainwater, surface water, domestic and industrial wastewater and sewage.

## Heavy-duty submersible sewage pumps 1.1 – 11 kW

This brochure describes the innovative SEV/SE1 pump lines. Fitted with SuperVortex or single-channel impellers, these pumps can meet approximately 80% of all wastewater pumping needs.



## Business with an attitude

**Knowledge** The sharing of knowledge, experience and expertise across our global network will always lead our business forward.

**Innovation** Combining the best technology with fresh ways of thinking, we will continue to develop even better pumps, systems, services and standards.

**Solution** With a complete product range, capable of providing every conceivable water solution, we are the most complete player on the market.

# motralec

4 rue Lavoisier . ZA Lavoisier . 95223 HERBLAY CEDEX

Tel. : 01.39.97.65.10 / Fax. : 01.39.97.68.48

Demande de prix / e-mail : [service-commercial@motralec.com](mailto:service-commercial@motralec.com)

[www.motralec.com](http://www.motralec.com)