

GR[®]
GORMAN-RUPP
PUMPS

Super

U SERIES  **S**[®]

SELF-PRIMING, HIGH-EFFICIENCY PUMPS



motralec

4 rue Lavoisier . ZA Lavoisier . 95223 HERBLAY CEDEX

Tel. : 01.39.97.65.10 / Fax. : 01.39.97.68.48

Demande de prix / e-mail : service-commercial@motralec.com

www.motralec.com

Super
U SERIES®

**THE MOST EFFICIENT SELF-PRIMING,
SOLIDS-HANDLING PUMPS AVAILABLE**

UP TO 75% EFFICIENCY

Super U Series® pumps are the most efficient self-priming, solids-handling pumps available. Their unique volute casing design minimizes friction loss and drag. The multi-vane, open impeller is designed for high efficiency, yet can still handle solids up to 1-1/4" (31 mm) in diameter. Super U Series® pumps not only deliver high efficiencies (up to 75%), they also perform efficiently across a broad operating range. Varying loads, which cause a pump to operate left or right of its best efficiency point on the operating curve, will reduce operating efficiency by only



a very small percentage. The patented external shimless adjustment makes it easy to keep the pump in peak operating condition. Each size pump is available in two different design variations, "A" or "B" versions.

EASY TO SERVICE

Super U Series® pumps are designed with easy service in mind. Because they're self-priming, they can be mounted high and dry above the liquid being pumped. If service or maintenance is required, it's done quickly and easily with common hand tools. No need to "pull the pump" and waste hours or days of valuable man and machine time. Since there are no elongated shafts, a minimum of workspace is required. And, because all Super U Series® pumps can be coupled to a standard NEMA motor, there's no waiting around for special motor parts.



Super U SERIES®

- 1 Handles up to 1-1/4" Solids
- 2 Suction Check Valve*
- 3 Inner O-Ring Seal
- 4 Replaceable Wearplate
- 5 Impeller
- 6 Oversize Seal Oil Chamber
- 7 Seal Oil Monitor
- 8 Removable Rotating Assembly
- 9 Bearing Oil Monitor
- 10 Pusher Bolt Capability
- 11 Optional Casing Heater
- 12 Double Lip Seals
- 13 Atmospheric Bearing Isolation
- 14 Cartridge Mechanical Seal
- 15 Easy-Off Coverplate Nuts
- 16 Removable Coverplate
- 17 Easy-Grip Handle
- 18 Pressure Relief Valve
- 19 Pusher Bolt Capability
- 20 Shimless Coverplate Adjustment

* "B" version only.

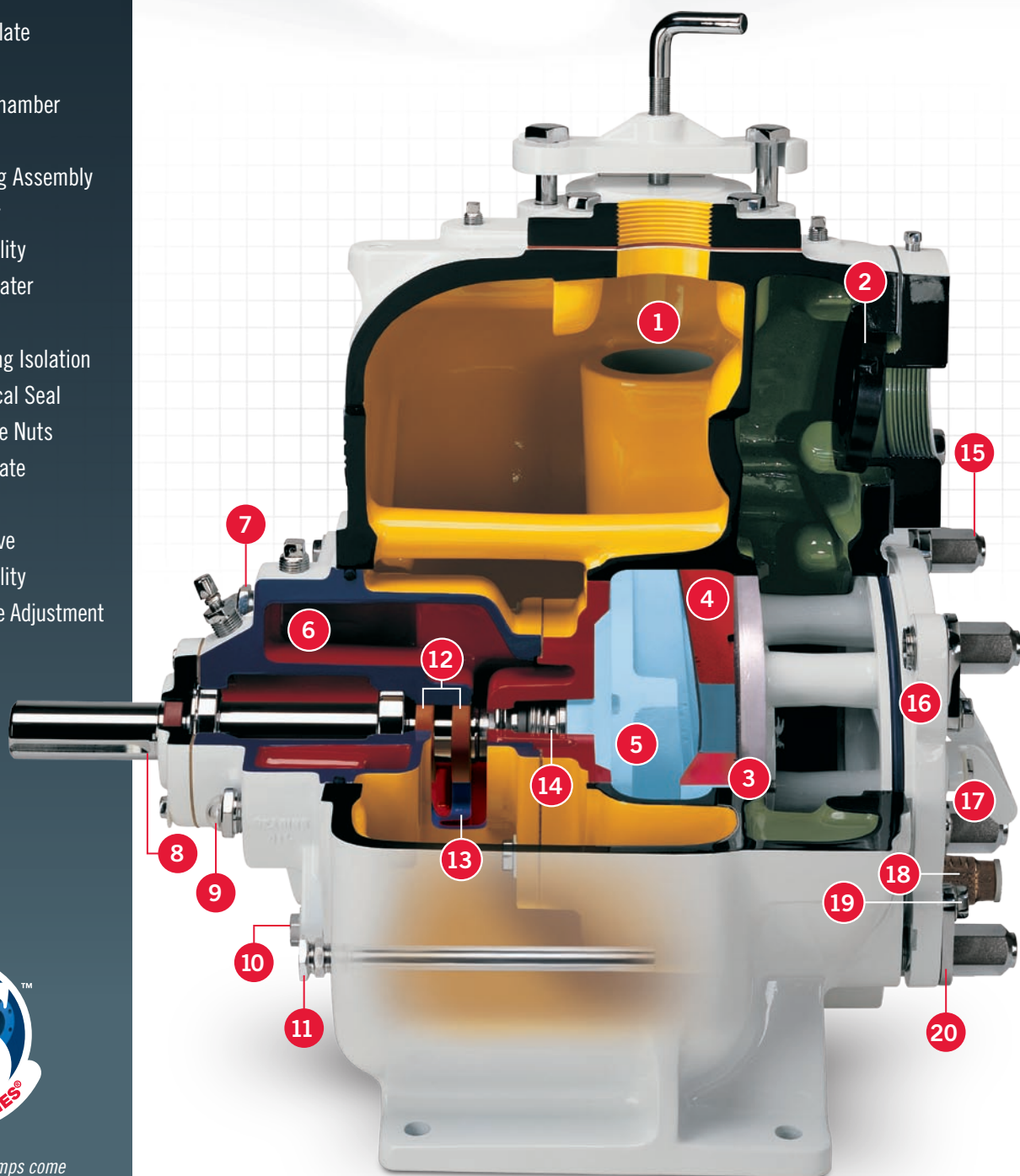

All Super U Series® pumps come standard with an industry-leading five-year warranty.

Super U Series® "B" Version Shown

SERVICE AND MAINTENANCE WITHOUT DISCONNECTING PIPING



EASILY REMOVABLE COVERPLATE

If service is required, the removable coverplate with “easy-grip” handle and pusher bolt capability provides quick and easy access to the pump interior without disconnecting piping.* Clogs can be removed and the pump can be returned to service in minutes. Impeller, seal, replaceable wearplate and suction check valve* can also be accessed through the coverplate opening for inspection or service.

***“B” version only.*

PATENTED EXTERNAL SHIMLESS ADJUSTMENT DESIGN DOUBLES THE LIFE OF THE IMPELLER AND WEARPLATE

The external shimless coverplate allows for easy adjustment of the clearance between the impeller and the wearplate. This process eliminates the need to realign belts, couplings or other drive components. In turn, the working height of the seal assembly and impeller back clearance are not disturbed. The unique collar and adjusting screw allow for incremental adjustments of the wearplate clearance with the turn of a hand.

Once adjustments have been made, the collar locks in place, maintaining the clearance setting even if the coverplate is removed.

This design doubles the life of the impeller and wearplate and keeps the pump operating at maximum efficiency.



MULTI-VANE SOLIDS-HANDLING IMPELLER

Multi-vane, open impeller is designed for high efficiency. Constructed of ductile iron, the impeller will handle up to 1-1/4" (31 mm) diameter solids.

GORMAN-RUPP CARTRIDGE SEAL

Exclusive double-floating, self-aligning, oil lubricated mechanical cartridge seal with stationary and rotating face of silicon carbide is specifically designed for rugged, abrasive service. Consult factory for additional seal configurations.



REMOVABLE ROTATING ASSEMBLY

Inspection of pump shaft or bearings is easily accomplished without disturbing pump casing or piping by removing rotating assembly. Simply remove four bolts from the back or front** of the pump and the entire assembly slides out.



***6" models only.*

DUAL PROTECTION OF BEARINGS

Atmospheric isolation of seal cavity provides positive protection of the bearings. This unique design also provides capabilities for external monitoring.

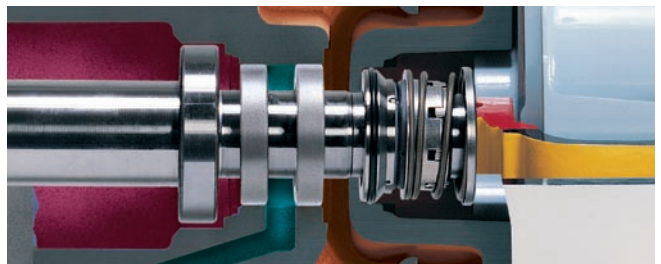

Super U SERIES®

Super U Series® pumps are available in 3", 4" and 6" discharge sizes. They are capable of handling spherical solids up to 1-1/4" in diameter. There are two different pump design variations to choose from, the "A" or "B" version (depending on installation requirements or performance needs).

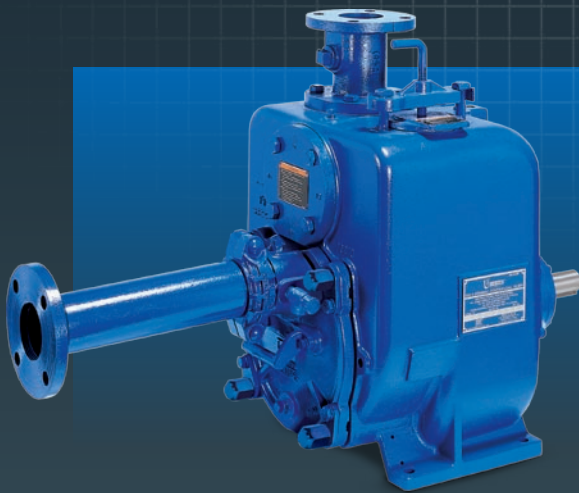

"A" VERSION

Highest Efficiency

The "A" version provides more efficiency than the "B" version because the liquid enters directly into the impeller eye.

Removable Spool Flange

A victaulic collar couples the suction extension to the removable coverplate for easy access to pump interior, should the pump need service.

"B" VERSION

The "B" version of the Super U Series® is dimensionally interchangeable (suction and discharge dimensions) with Gorman-Rupp Super T Series® pump models. A removable coverplate with easy-grip handle provides quick access to pump interior, should the pump need to be serviced.

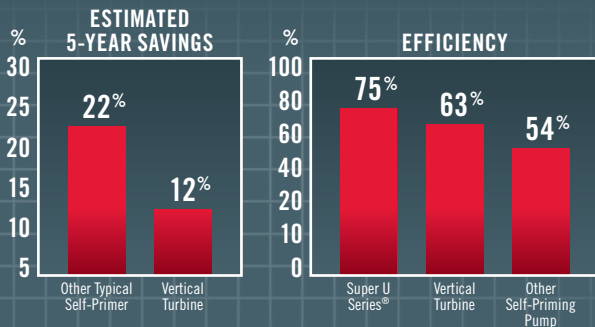

The 5-year savings generated when you install a Super U Series® high efficiency pump.

DRIVE VARIATIONS

Gorman-Rupp Super U Series® pumps are available as basic units for connection to customers' power or they may be flex-coupled or V-belt driven by an electric motor.

When space is critical, flex-coupling often solves the "tight-fit" problem. V-belt drive offers the advantage of flexibility in speed selection and usually provides maximum operating speed for required head and capacity without the need to trim the impeller. Various belt and sheave configurations are available.

SIZES

3", 4", 6"
(75 mm, 100 mm, 150 mm)

MATERIALS OF CONSTRUCTION

Cast iron,
316 stainless steel fitted,
CD4MCU, G-R Hard Iron fitted

MAX. CAPACITY

1500 gpm
(95 lps)

Max. Head

207'
(63 m)

Max. Solids

1-1/4"
(31 mm)

A
VERSION

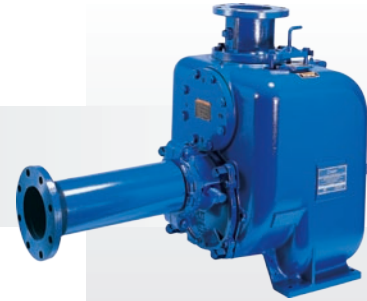

B
VERSION



3"

Super U Series®
Shown with optional flanges

4"

Super U Series®
Shown with optional flanges

6"

Super U Series®
Shown with optional flanges

"A" VERSION

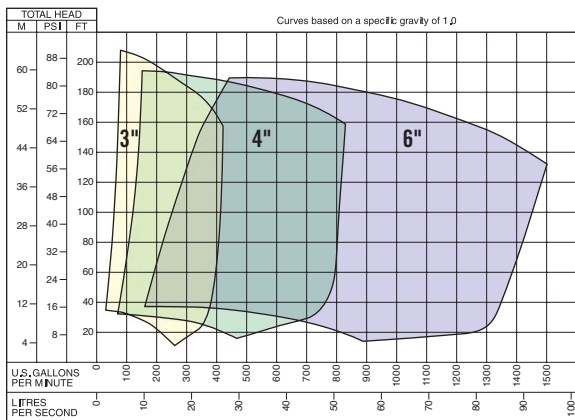

"B" VERSION

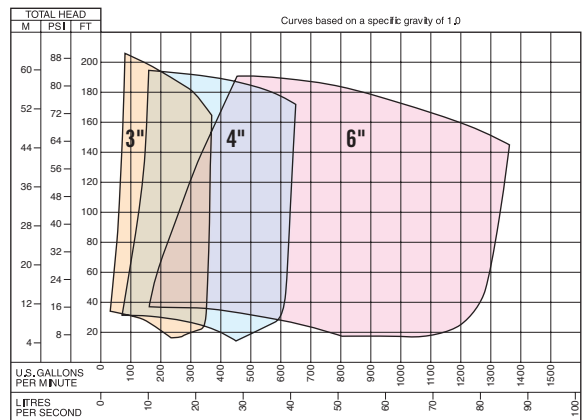

Note: Consult factory for other performance conditions.



AV-05573_1108

motralec

4 rue Lavoisier . ZA Lavoisier . 95223 HERBLAY CEDEX
Tel. : 01.39.97.65.10 / Fax. : 01.39.97.68.48
Demande de prix / e-mail : service-commercial@motralec.com

www.motralec.com

