



ISO 9001 Certified  
CE Compliant

# KVT3.60 - 3.140 Series

## 100% OIL-LESS VACUUM PUMPS

The Becker KVT3.60 - 3.140 series pumps are 100% oil-less rotary vane vacuum pumps. They are designed to operate on a continuous basis at any point from atmospheric pressure to a vacuum level of 27" HgV (75 torr).

The KVT series pumps are direct drive units and are supplied with a high efficiency TEFC, C-face, flange mounted electric motor. Each pump is equipped with an integral vacuum relief valve, a 5µ inlet filter, and vibration isolators as standard equipment.

Becker KVT series pumps have a reputation for being exceptionally quiet. These award-winning pumps are newly redesigned to make them even quieter and

cooler running than previous units. If you are an OEM, their styling will never cause embarrassment when included with your product.

These 100% oil-less, or dry, pumps are ideal for applications where oil or water is objectionable. All Becker KVT pumps use long-life, self-lubricating graphite composite vanes. Applications include the graphic arts, packaging, vacuum chucking, robotics and material handling, medical/surgical, and air sampling, among others.

These pumps are also available in various central vacuum system configurations. Pressure and combined pressure/vacuum pumps are available.

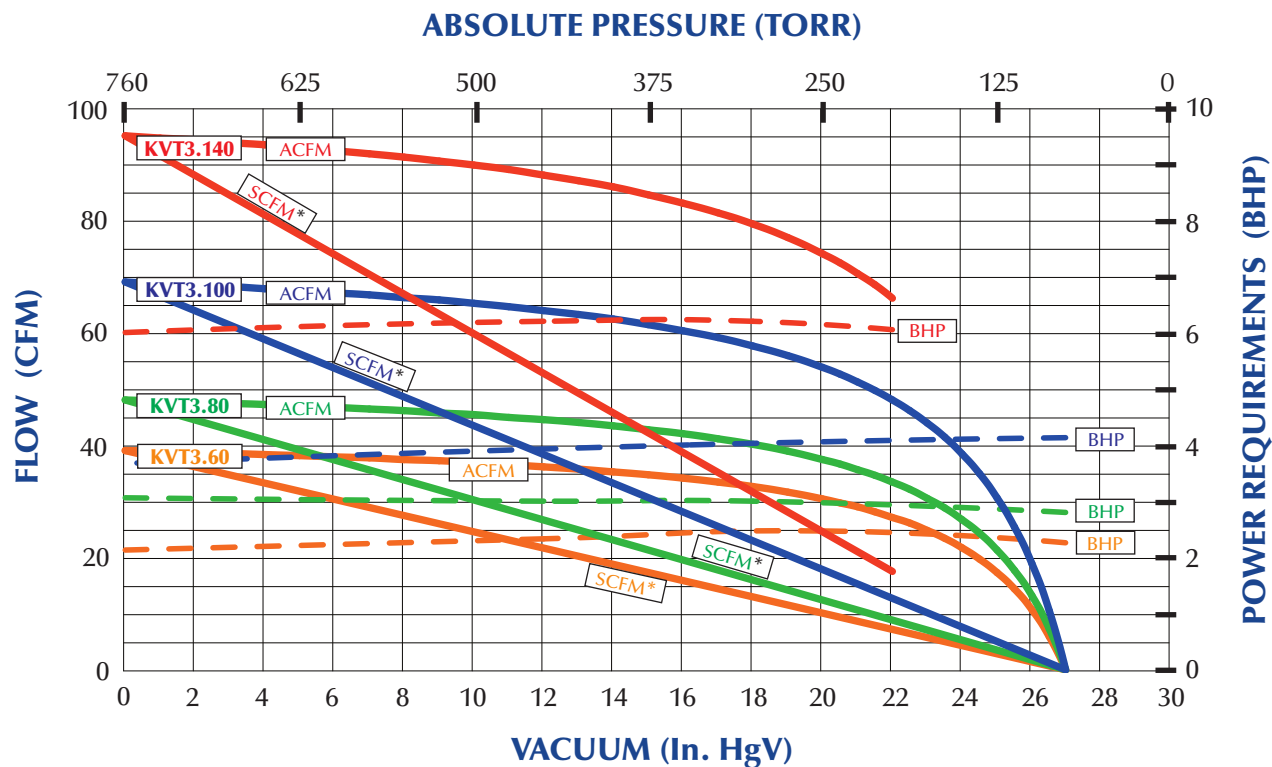

\* @ 29.92" Hg Bar. Pr.; 68°F; 36% R.H.; 0.075#/ft³

## TECHNICAL DATA

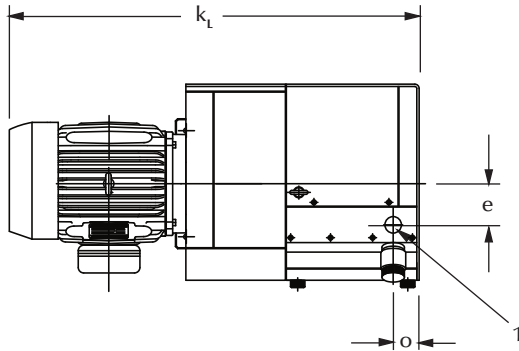

Top View

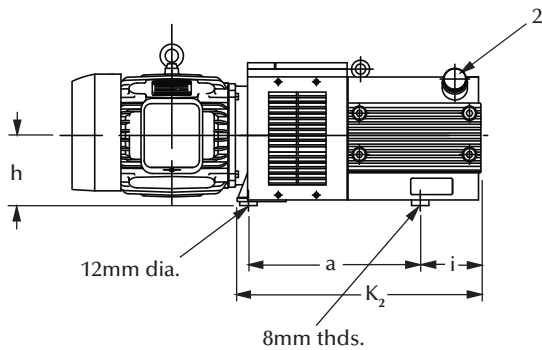

Side View

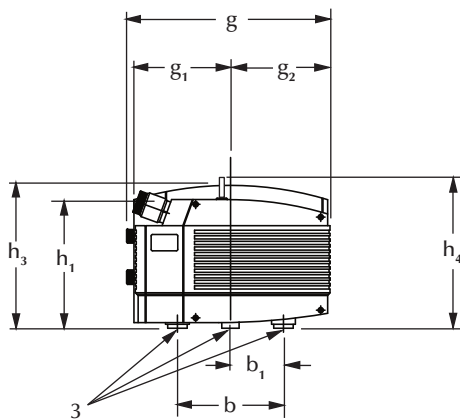

End View (Opposite Motor End)

All data based on 60 Hz operation

	KVT3.60	KVT3.80	KVT3.100	KVT3.140	
Flow (SCFM @ 0 in. Hg)	39	48	69	95	
Horsepower	3	5	5	7½	
Speed (RPM)	1740	1740	1740	1740	
Max. Cont. Vacuum (in. HgV)	27	27	27	22	
Weight (lbs.)—w/o motor	104	108	156	172	
Weight (lbs.)—w/ motor*	151	178	230	320	
Noise Level (Max. dBA)	73	75	77	79	
Inlet size (BSP, inches)	1	1	1½	1½	
<b>Dimensional Data</b>	<b>(Inches)</b>				
	a	12.83	12.83	15.67	15.67
	b	7.5	7.5	9.65	9.65
	b <sub>1</sub>	3.75	3.75	4.82	4.82
	e <sub>1</sub>	2.56	2.56	3.75	3.75
	g	13.9	13.9	18.5	18.5
	g <sub>1</sub>	7.68	7.68	8.78	8.78
	g <sub>2</sub>	5.55	5.55	9.06	9.06
	h	6.38	6.38	6.38	6.38
	h <sub>1</sub>	11.38	11.38	11.7	11.7
	h <sub>3</sub>	12.28	12.28	13.0	13.0
	h <sub>4</sub>	12.9	12.9	13.25	13.25
	i	3.78	3.78	5.5	5.5
	k <sub>2</sub>	17.64	17.64	22.17	22.17
k <sub>L</sub>	29.4	29.4	33.5	36.8	
o	1.81	1.81	2.36	2.36	

\* Overall specifications for single phase units may vary. Contact factory for information. Manufacturer reserves right to alter data without notice.

- 1 - Inlet Port
- 2 - Vibration Isolator
- 3 - Vacuum Regulating Valve
- 4 - Exhaust Air Silencer