

## PLAGES D'UTILISATION

Débits jusqu'à :	380 m <sup>3</sup> /h
Hauteurs mano. jusqu'à :	85 m
Plage température fluide :	- 20 ° à +140°C
Hauteurs mano. jusqu'à :	85 m
Pression service jusqu'à :	13 bar jusqu'à +140°C 16 bar jusqu'à +120°C
DN aspiration jusqu'à :	125 mm
DN refoulement jusqu'à :	125 mm
PN brides :	16 bar
MEI* de référence :	≥ 0,10

\*Minimum Efficiency Index

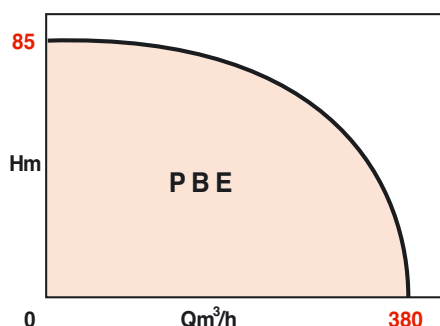

## AVANTAGES

- Régulation  $\Delta p$ -c (capteur externe en option), PID (via un capteur approprié) et n-constante
- Large couverture de performance hydraulique (750-2900 tr/min et 380-1450 tr/min)
- Interface identique aux pompes SIE, DIE, LRE et JRE
- Un seul bouton pour la navigation et paramètres visibles sur l'écran LCD
- Interfaces 0-10 V, 2-10 V, 0-20 mA, 4-20 mA pour la comptabilité avec la majorité des organes de commande
- Communication bus grâce aux modules IF embrochables (en option)
- Verrouillage des paramètres par un switch DIP
- Signaux des relais configurables en SSM et SBM pour une intégration optimale dans la GTC
- Sonde PTC intégrée pour la protection intensités (relais thermique non nécessaire)
- Fonctionnement en pompe double avec contrôle par une pompe maître
- Revêtement cataphorèse pour une protection anticorrosion
- Rainures d'évacuation des condensants pour une utilisation en eau glacée

N.T. N° 125-9/FR. - Éd.6/12-15

# PBE

## POMPES MONOBLOC HORIZONTALES NORMALISÉES

### Chauffage - climatisation Adduction - surpression

# 50 Hz

Norme A.C.S. : nous consulter

## APPLICATIONS

- Circulation d'eau chaude suivant VDI2035 ou d'eau froide
- Circuits d'eau glacée ou glycolée jusqu'à 40% de glycol et température 40°C
- Circuits d'eau de refroidissement
- Irrigation, lavage
- Vidange, remplissage, surpression
- Toutes industries où il s'agit de pomper des liquides clairs, non abrasifs et chimiquement neutres.

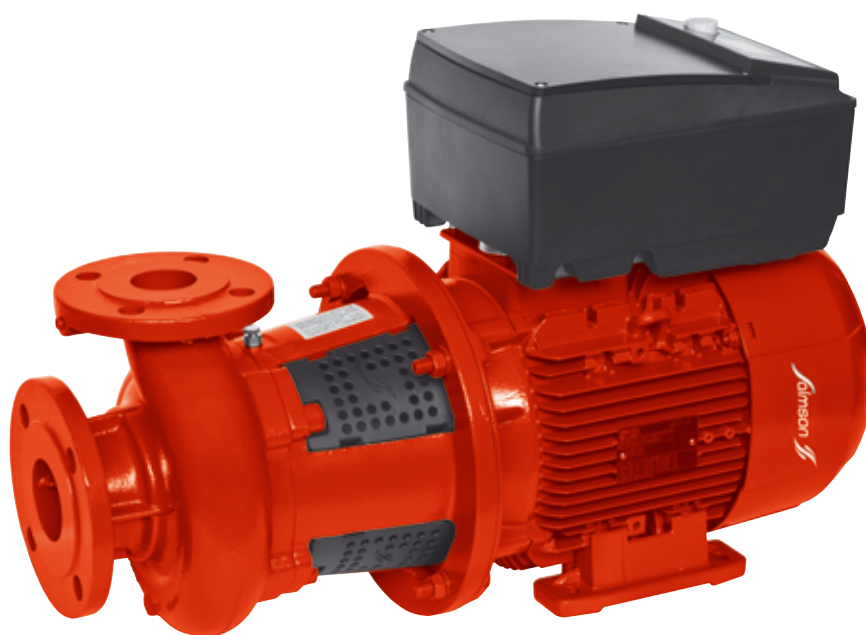

# PBE

## CONCEPTION

### • Partie hydraulique

- Pompe centrifuge monocellulaire monobloc horizontale normalisée.
- Raccordement à brides normalisées
- Roue fermée
- Aspiration axiale et refoulement vertical

### • Etanchéité

- Garniture mécanique normalisée

### • Moteur

- Accouplement rigide
- Moteur ventilé IE2

Alimentation réseau : ~400 V, 50/60 Hz

Classe d'isolation : 155 (F)

Indice de protection : IP55

Emission : EN 61800-3

Immunité : EN 61800-3

### • Variateur de vitesse

- Ecran LCD
- Réglage par un bouton unique

## IDENTIFICATION

PBE 203 - 14 / 2,2 - R1

Gammes de produits \_\_\_\_\_

Nombre de pôles \_\_\_\_\_

Diamètre nominal de la bride de refoulement \_\_\_\_\_

03 : 32mm

04 : 45mm

05 : 50 mm

06 : 65 mm

08 : 80 mm

10 : 100 mm

12 : 125 mm

Diamètre nominal de la roue en mm \_\_\_\_\_

Puissance P2 en kW \_\_\_\_\_

Sans capteur de pression \_\_\_\_\_

## CONSTRUCTION DE BASE

Pièces principales	Matériau
Corps de pompe	Fonte EN-GJL-250 ou fonte sphéroïdale EN-GJS-400-18-LT*
Lanterne	Fonte EN-GJL-250 ou fonte sphéroïdale EN-GJS-400-18-LT*
Arbre moteur	Inox 1.4122
Roue	Fonte EN-GJL-200 ou bronze G-CuSn 10*
Garniture mécanique	AQEGG

\* Options, nous consulter

## ABAQUE PRÉSÉLECTION

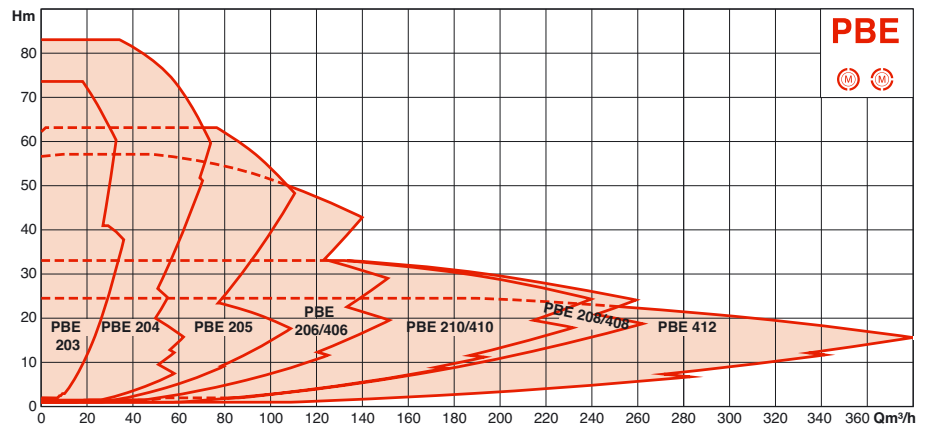

## VARIATION ÉLECTRONIQUE DE VITESSE

## Description

1,5 - 7,5 kW

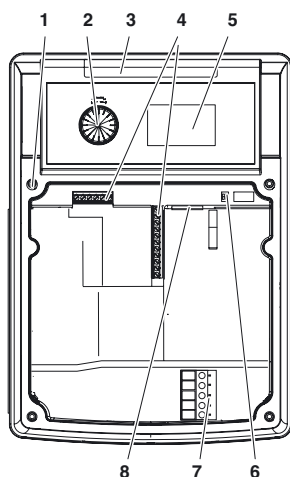

11 - 22 kW

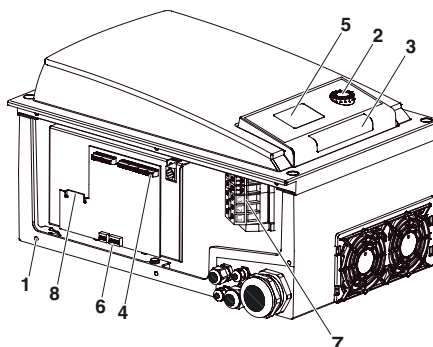

- 1 Fixation du couvercle
- 2 Bouton de contrôle
- 3 Fenêtre communication infra-rouge
- 4 Connecteurs de commande
- 5 Affichage
- 6 Interrupteurs
- 7 Bornier de puissance
- 8 Interface pour les modules IF

## Fonctionnalités

## Modes automatiques

- $\Delta p$ -c pour pression différentielle constante (avec un DDG externe)
- Contrôle PID
- Mode réglage manuel (n = constant)

## Sécurité

- Protection moteur intégrale avec déclencheur électronique intégré
- Verrouillage d'accès

## Réglages manuelles

- Réglage de la consigne de pression différentielle
- Réglage de la vitesse de rotation (mode réglage)
- Réglage du mode de fonctionnement
- Réglage de la pompe sur MARCHE/ARRET
- Configuration de tous les paramètres de fonctionnement
- Acquiescement des défauts

## Pilotage pompes doubles (pompe double ou 2 pompes simples)

- Mode de fonctionnement principal/de réserve (permutation automatique en cas de défaut)
- Mode de fonctionnement principal/de réserve permutation des pompes au bout de 24 heures
- Marche parallèle
- Marche parallèle (avec optimisation du rendement en fonction des besoins)

## Fonctions de commandes externes

- Entrée de commande « Priorité Off ».
- Entrée de commande « Permutation des pompes externe » (uniquement active en mode double pompe).
- Entrée analogique 0-10 V, 0-20 mA pour mode réglage (DDC) et réglage à distance de la valeur de consigne.

- Entrée analogique 2-10 V, 4-20 mA pour mode réglage (DDC) et réglage à distance de la valeur de consigne.
- Entrée analogique 0-10 V pour le signal valeur réelle du capteur de pression.
- Entrée analogique 2-10 V, 0-20 mA, 4-20 mA pour signal valeur réelle du capteur de pression.

## Signalisation et affichage

- Report de défauts centralisé SSM.
- Report de marche centralisé SBM.

## Echange de données

Interface infrarouge pour l'échange de données sans fil avec le Pump Control.  
Emplacement pour modules IF Salmson (Modbus, BACnet, CAN, PLR, LON) pour la connexion à la gestion technique centralisée  
Interface pour le pilotage pompes doubles.

# PBE

## POSITIONS DE MONTAGE

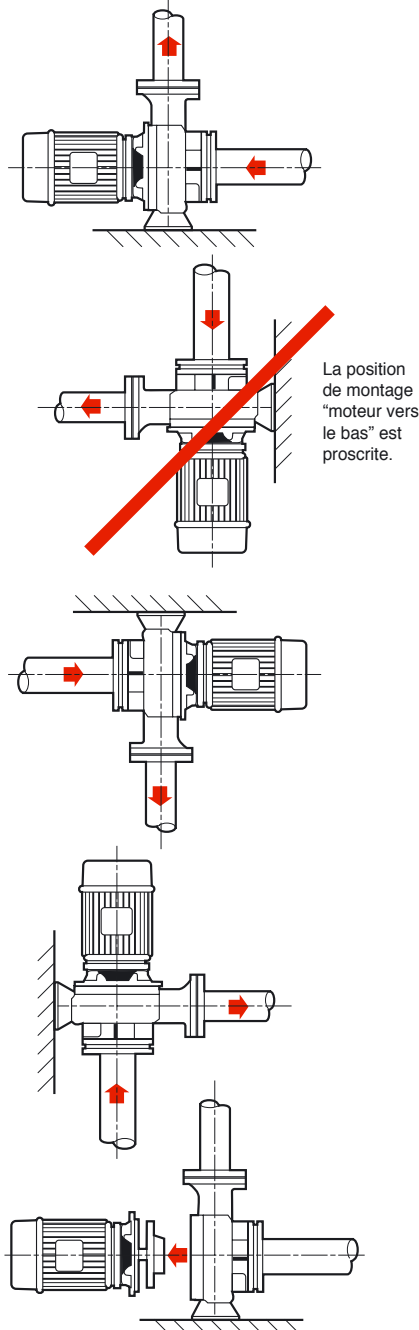

## ACCESSOIRES RECOMMANDES

- **Kit capteur de pression différentielle** pour les versions R1, mesure de 0 à 10 bar, sortie 0-10 V (à installer à l'aspiration et au refoulement de la pompe sur une longueur droite).
- Kit composé de :
  - Capteur de pression différentiel avec câble de 2 m,
  - Capillaire cuivre de Ø 3 mm et de longueur 2 m,
  - Accessoires de montage

Pompe		Kit capteur de pression	
Référence	Désignation	Référence	Désignation
2126163	PBE203-14/2.2-R1	2137283	DDG40-9 PBE
2126164	PBE203-15/3-R1	2137283	DDG40-9 PBE
2126165	PBE203-16/4-R1	2137283	DDG40-9 PBE
2126166	PBE203-17/5.5-R1	2137286	DDG60-5 PBE
2126167	PBE203-21/7.5-R1	2137288	DDG100-2 PBE
2126168	PBE203-22/11-R1	2137289	DDG100-3 PBE
2126169	PBE204-11/1.5-R1	2137280	DDG20-10 PBE
2126170	PBE204-12/2.2-R1	2137280	DDG20-10 PBE
2126171	PBE204-13/3-R1	2137283	DDG40-9 PBE
2126172	PBE204-14/4-R1	2137283	DDG40-9 PBE
2126173	PBE204-16/5.5-R1	2137284	DDG40-10 PBE
2126174	PBE204-17/7.5-R1	2137286	DDG60-5 PBE
2126175	PBE204-18/7.5-R1	2137286	DDG60-5 PBE
2126176	PBE204-21/11-R1	2137287	DDG60-6 PBE
2126177	PBE204-22/15-R1	2137289	DDG100-3 PBE
2113494	PBE204-23/18.5-R1	2137289	DDG100-3 PBE
2126178	PBE204-24/22-R1	2137289	DDG100-3 PBE
2126179	PBE205-11/3-R1	2137280	DDG20-10 PBE
2126180	PBE205-12/4-R1	2137280	DDG20-10 PBE
2126181	PBE205-13/5.5-R1	2137284	DDG40-10 PBE
2126182	PBE205-14/7.5-R1	2137284	DDG40-10 PBE
2126183	PBE205-15/7.5-R1	2137284	DDG40-10 PBE
2126184	PBE205-17/11-R1	2137287	DDG60-6 PBE
2126185	PBE205-20/15-R1	2137287	DDG60-6 PBE
2126186	PBE205-21/18.5-R1	2137287	DDG60-6 PBE
2126187	PBE205-22/22-R1	2137289	DDG100-3 PBE
2126188	PBE405-27/5.5-R1	2137284	DDG40-10 PBE
2126189	PBE206-12/4-R1	2137280	DDG20-10 PBE
2126190	PBE206-13/5.5-R1	2137281	DDG20-11 PBE
2126191	PBE206-14/7.5-R1	2137284	DDG40-10 PBE
2126192	PBE206-16/11-R1	2137285	DDG40-11 PBE
2126193	PBE206-17/15-R1	2137285	DDG40-11 PBE
2126194	PBE206-19/18.5-R1	2137287	DDG60-6 PBE
2126195	PBE206-21/22-R1	2137287	DDG60-6 PBE
2126196	PBE406-24/5.5-R1	2137284	DDG40-10 PBE
2113533	PBE406-26.5/7.5-R1	2137284	DDG40-10 PBE
2126197	PBE208-14.5/11-R1	2137285	DDG40-11 PBE
2126198	PBE208-15/15-R1	2137285	DDG40-11 PBE
2126199	PBE208-16/18.5-R1	2137285	DDG40-11 PBE
2126200	PBE208-16.5/22-R1	2137285	DDG40-11 PBE
2126201	PBE408-22/5.5-R1	2137281	DDG20-11 PBE
2126202	PBE408-25/7.5-R1	2137284	DDG40-10 PBE
2126203	PBE408-27/11-R1	2137285	DDG40-11 PBE
2126204	PBE410-20/5.5-R1	2137281	DDG20-11 PBE
2126205	PBE410-22/7.5-R1	2137281	DDG20-11 PBE
2126206	PBE410-25/11-R1	2137282	DDG20-12 PBE
2126207	PBE410-27/15-R1	2137285	DDG40-11 PBE
2126208	PBE410-30.5/18.5-R1	2137285	DDG40-11 PBE
2126209	PBE410-31.5/22-R1	2137285	DDG40-11 PBE
2126210	PBE412-18.5/5.5-R1	2137281	DDG20-11 PBE
2126211	PBE412-21/7.5-R1	2137281	DDG20-11 PBE
2126212	PBE412-22.5/11-R1	2137282	DDG20-12 PBE
2126213	PBE412-25/15-R1	2137282	DDG20-12 PBE
2126214	PBE412-26/18.5-R1	2137285	DDG40-11 PBE
2126215	PBE412-27/22-R1	2137285	DDG40-11 PBE

Nota : il ne doit pas être raccordé sur les bossages de la pompe tels que les LRE/JRE.

## PARTICULARITÉS

### • Installation

- Pour cette gamme l'installation en extérieur est interdite.

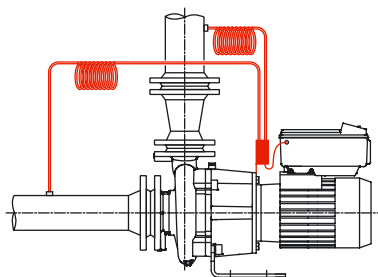

## CARACTERISTIQUES – MOTEUR ≤ 4KW

Code article	Désignation	Puissance nominale moteur (kW)	Intensité nominale (A)	Plage de vitesse (tr/min)	Niveau rendement moteur	DN		Masse nette (kg)
						aspiration (mm)	refoulement (mm)	
2126163	PBE203-14/2.2-R1	2,2	7,3	750-2900	IE2	50	32	57
2126164	PBE203-15/3-R1	3	9	750-2900	IE2	50	32	66
2126165	PBE203-16/4-R1	4	11,7	750-2900	IE2	50	32	73
2126169	PBE204-11/1.5-R1	1,5	5,6	750-2900	IE2	65	40	52
2126170	PBE204-12/2.2-R1	2,2	7,2	750-2900	IE2	65	40	53
2126171	PBE204-13/3-R1	3	8,9	750-2900	IE2	65	40	60
2126172	PBE204-14/4-R1	4	11,3	750-2900	IE2	65	40	70
2126179	PBE205-11/3-R1	3	8,8	750-2900	IE2	65	50	66
2126180	PBE205-12/4-R1	4	11,5	750-2900	IE2	65	50	73
2126189	PBE206-12/4-R1	4	10,7	750-2900	IE2	80	65	78

## CARACTERISTIQUES – MOTEUR &lt; 5KW

Code article	Désignation	Puissance nominale moteur (kW)	Intensité nominale (A)	Plage de vitesse (tr/min)	Niveau rendement moteur	DN		Masse nette (kg)
						aspiration (mm)	refoulement (mm)	
2126166	PBE203-17/5.5-R1	5,5	10,5	750-2900	IE2	50	32	95
2144338	PBE203-21/7.5-R1	7,5	13,5	750-2900	IE2	50	32	107
2154324	PBE203-22/11-R1-IE4	11	19,6	750-2900	IE4	50	32	192
2126173	PBE204-16/5.5-R1	5,5	11	750-2900	IE2	65	40	97
2126174	PBE204-17/7.5-R1	7,5	14	750-2900	IE2	65	40	101
2126175	PBE204-18/7.5-R1	7,5	14,1	750-2900	IE2	65	40	111
2154325	PBE204-21/11-R1-IE4	11	19,4	750-2900	IE4	65	40	195
2154326	PBE204-22/15-R1-IE4	15	24,2	750-2900	IE4	65	40	204
2154327	PBE204-23/18.5-R1-IE4	18,5	29,7	750-2900	IE4	65	40	260
2154328	PBE204-24/22-R1-IE4	22	36,5	750-2900	IE4	65	40	269
2126181	PBE205-13/5.5-R1	5,5	10,7	750-2900	IE2	65	50	92
2126182	PBE205-14/7.5-R1	7,5	13,8	750-2900	IE2	65	50	96
2126183	PBE205-15/7.5-R1	7,5	14,3	750-2900	IE2	65	50	103
2154329	PBE205-17/11-R1-IE4	11	19,5	750-2900	IE4	65	50	180
2154330	PBE205-20/15-R1-IE4	15	26,7	750-2900	IE4	65	50	205
2154331	PBE205-21/18.5-R1-IE4	18,5	32	750-2900	IE4	65	50	248
2154332	PBE205-22/22-R1-IE4	22	38,6	750-2900	IE4	65	50	258
2126190	PBE206-13/5.5-R1	5,5	11	750-2900	IE2	80	65	97
2126191	PBE206-14/7.5-R1	7,5	14,1	750-2900	IE2	80	65	101
2154333	PBE206-16/11-R1-IE4	11	19,2	750-2900	IE4	80	65	186
2154334	PBE206-17/15-R1-IE4	15	26	750-2900	IE4	80	65	194
2154335	PBE206-19/18.5-R1-IE4	18,5	31,8	750-2900	IE4	80	65	254
2154336	PBE206-21/22-R1-IE4	22	38	750-2900	IE4	80	65	267
2154337	PBE208-14.5/11-R1-IE4	11	20	750-2900	IE4	100	80	201
2154338	PBE208-15/15-R1-IE4	15	26,3	750-2900	IE4	100	80	209
2154340	PBE208-16.5/22-R1-IE4	22	37,8	750-2900	IE4	100	80	262
2154339	PBE208-16/18.5-R1-IE4	18,5	32,1	750-2900	IE4	100	80	252
2126188	PBE405-27/5.5-R1	5,5	10,7	380-1450	IE2	65	50	119
2126196	PBE406-24/5.5-R1	5,5	10,8	380-1450	IE2	80	65	135
2113533	PBE406-26.5/7.5-R1	7,5	13,9	380-1450	IE2	80	65	142
2144343	PBE408-22/5.5-R1	5,5	10,2	380-1450	IE2	100	80	126
2144344	PBE408-25/7.5-R1	7,5	13,4	380-1450	IE2	100	80	144
2154341	PBE408-27/11-R1-IE4	11	18,8	380-1450	IE4	100	80	261
2144346	PBE410-20/5.5-R1	5,5	10	380-1450	IE2	125	100	133
2144347	PBE410-22/7.5-R1	7,5	13,5	380-1450	IE2	125	100	140
2154342	PBE410-25/11-R1-IE4	11	19,1	380-1450	IE4	125	100	275
2154343	PBE410-27/15-R1-IE4	15	25,3	380-1450	IE4	125	100	292
2154344	PBE410-30.5/18.5-R1-IE4	18,5	30	380-1450	IE4	125	100	396
2154345	PBE410-31.5/22-R1-IE4	22	36,9	380-1450	IE4	125	100	410
2126210	PBE412-18.5/5.5-R1	5,5	11	380-1450	IE2	150	125	168
2126211	PBE412-21/7.5-R1	7,5	14,2	380-1450	IE2	150	125	175
2154346	PBE412-22.5/11-R1-IE4	11	19,1	380-1450	IE4	150	125	290
2154347	PBE412-24.5/15-R1-IE4	15	25,9	380-1450	IE4	150	125	336
2154348	PBE412-26.5/18.5-R1-IE4	18,5	31,8	380-1450	IE4	150	125	393
2154349	PBE412-27.5/22-R1-IE4	22	38	380-1450	IE4	150	125	407

# PBE

## PERFORMANCES HYDRAULIQUES

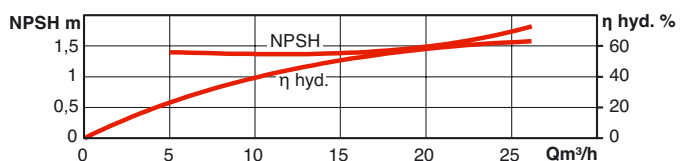
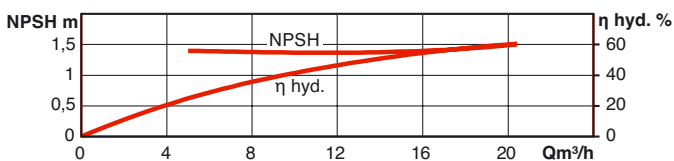
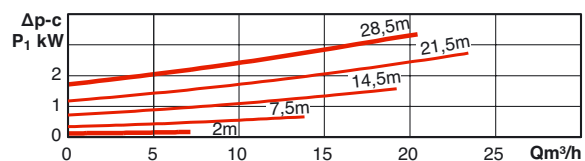
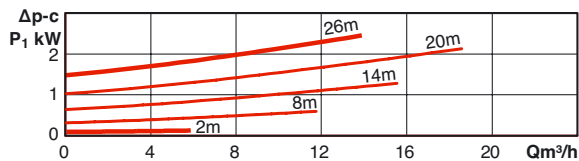
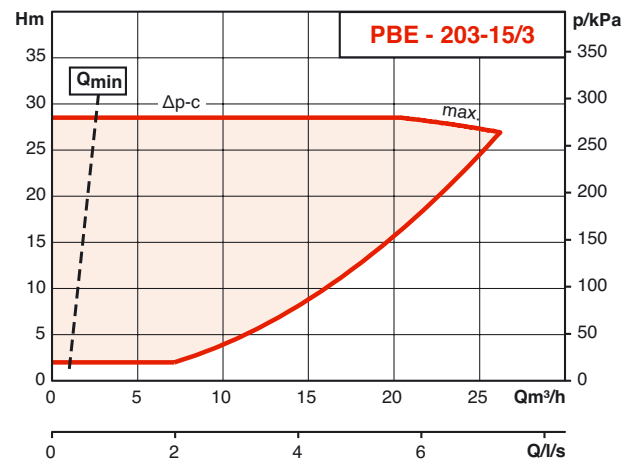
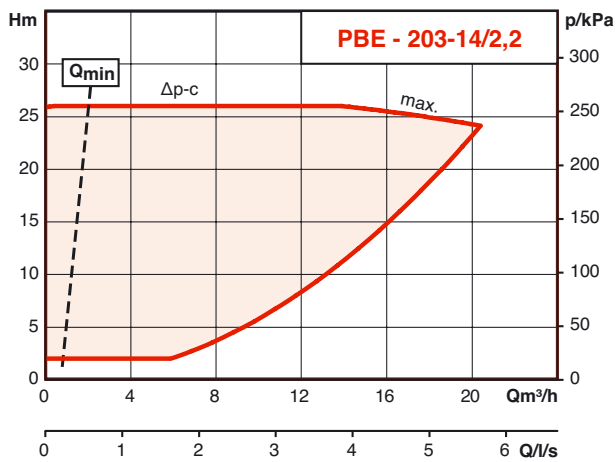
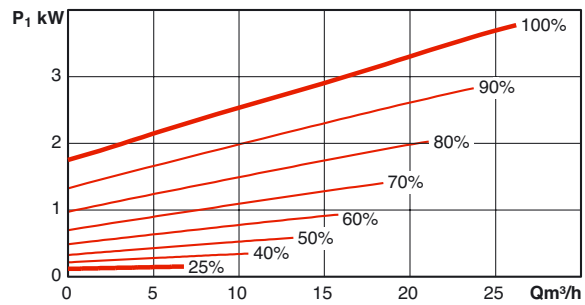
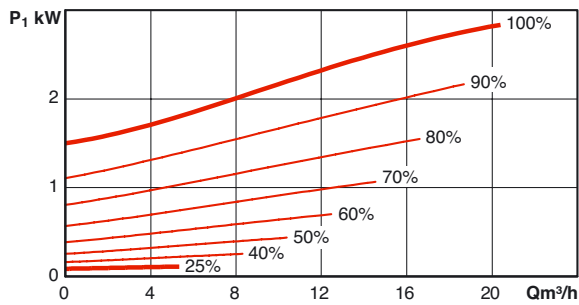
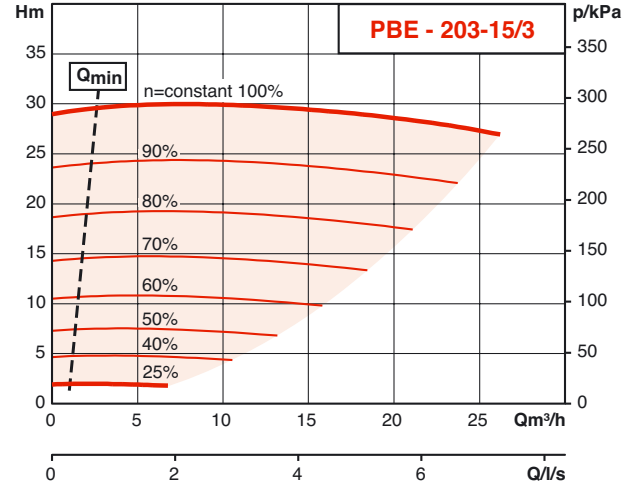
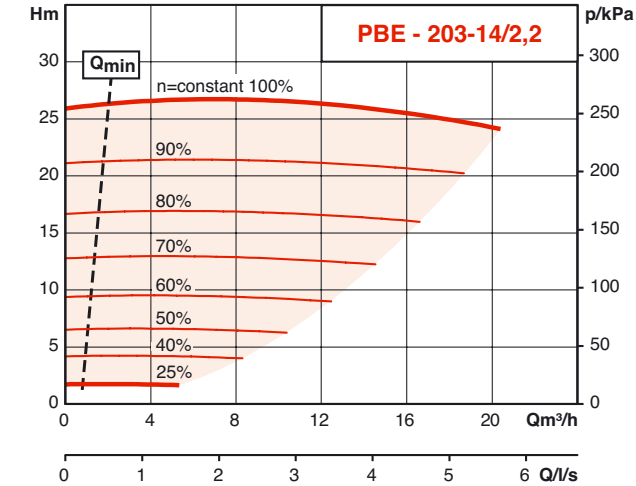

PERFORMANCES HYDRAULIQUES

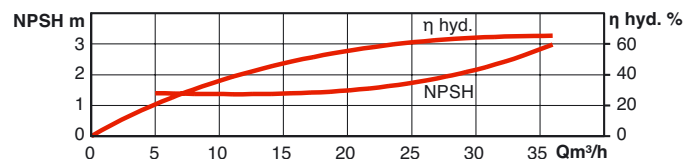
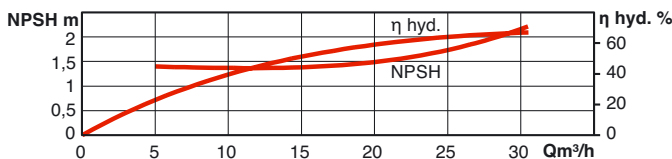
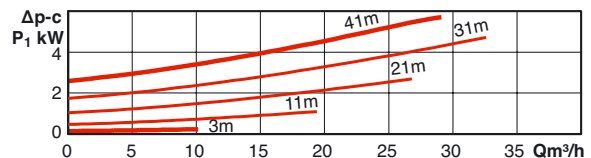
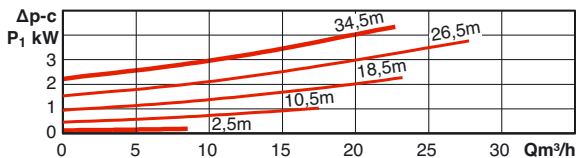
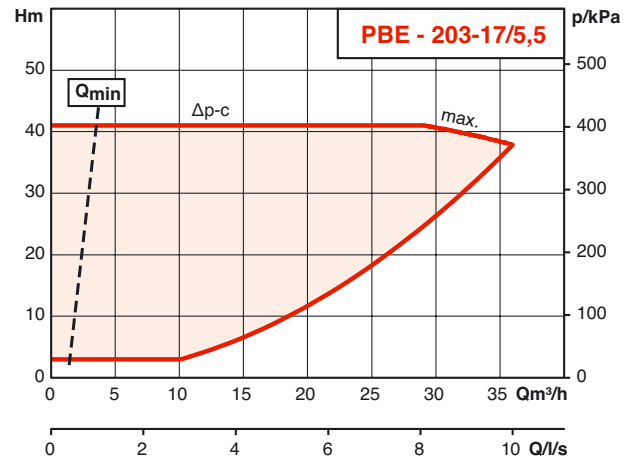
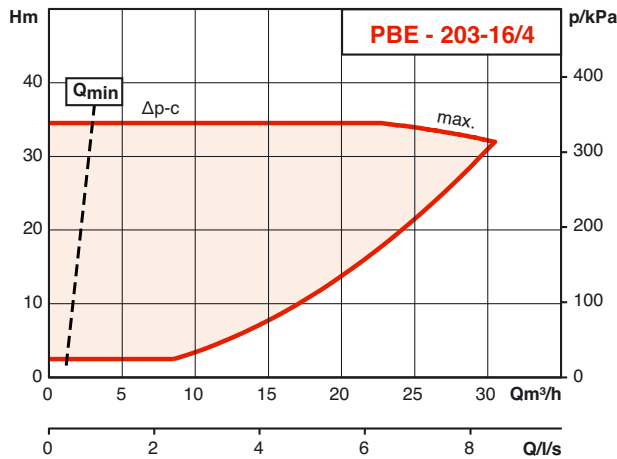
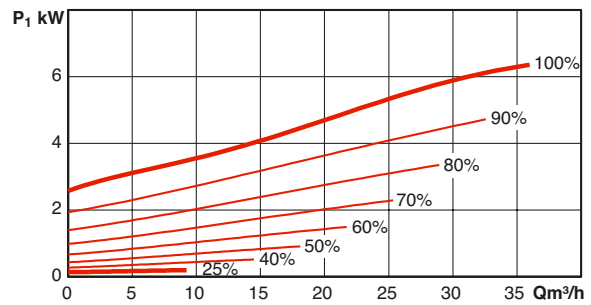
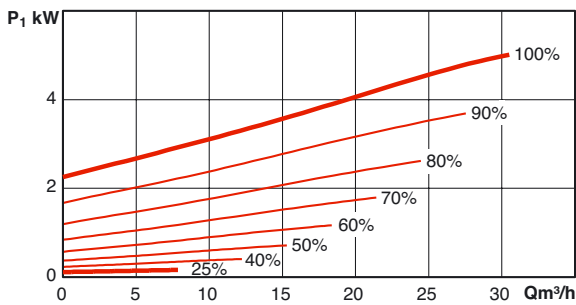
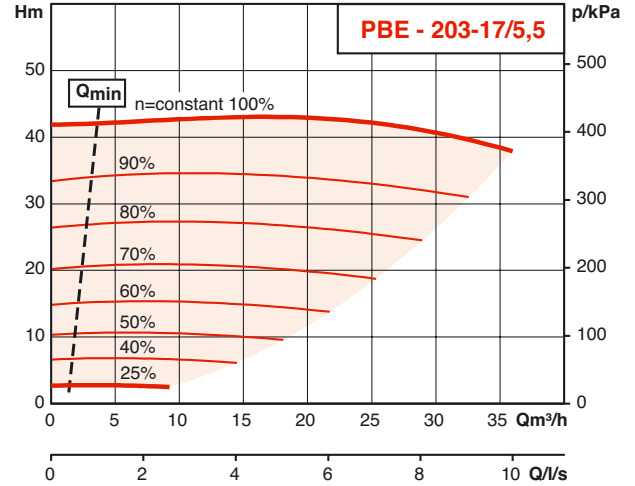
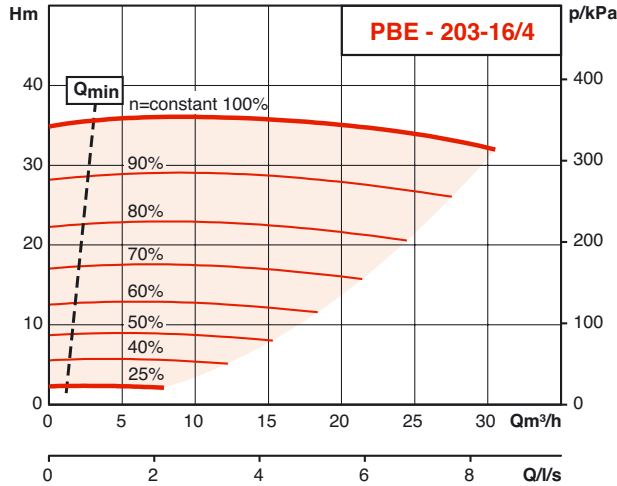

Génie climatique  
Pompes à rotor sec

# PBE

## PERFORMANCES HYDRAULIQUES

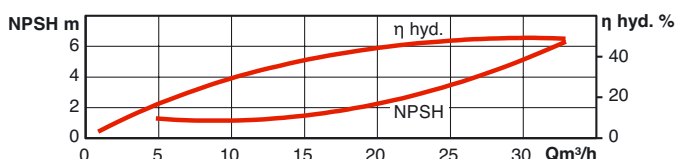
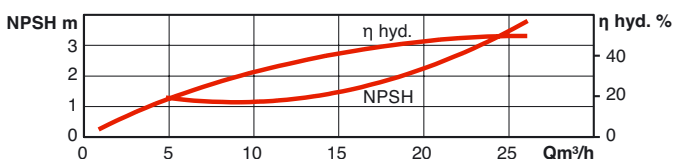
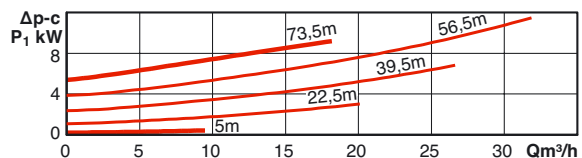
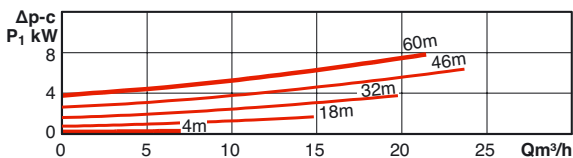
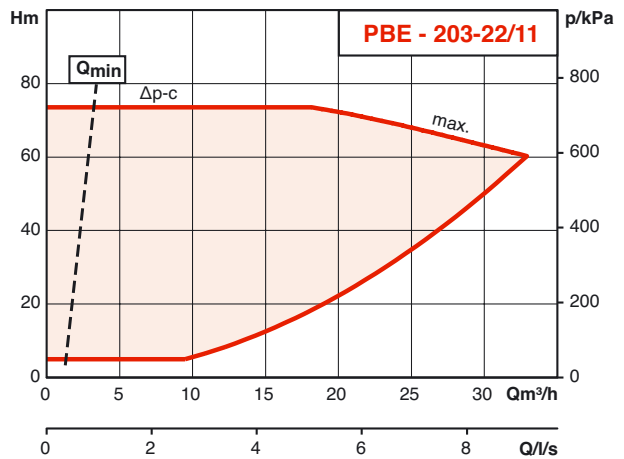
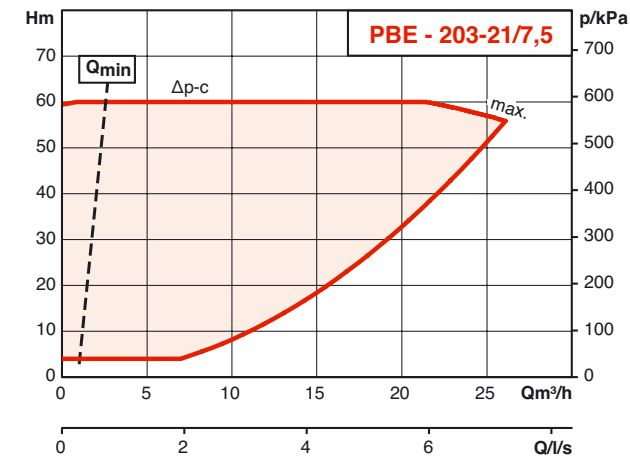
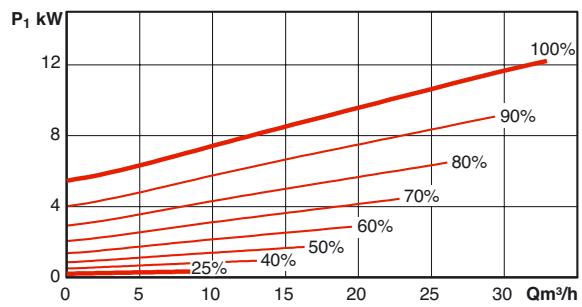
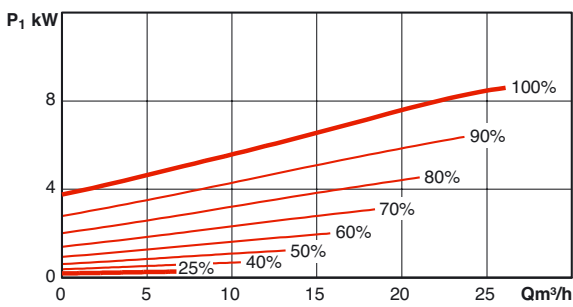
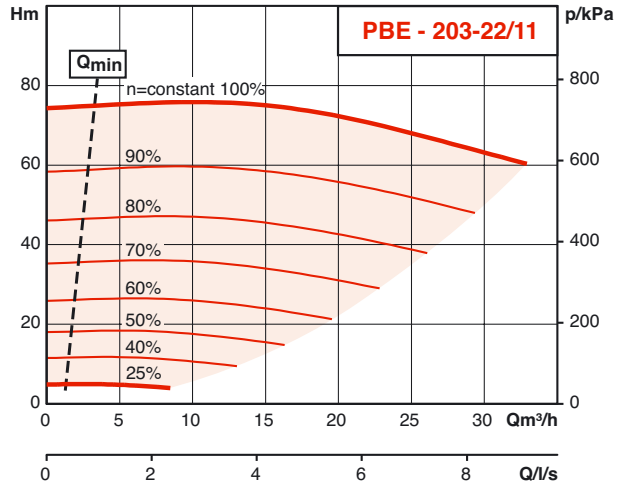
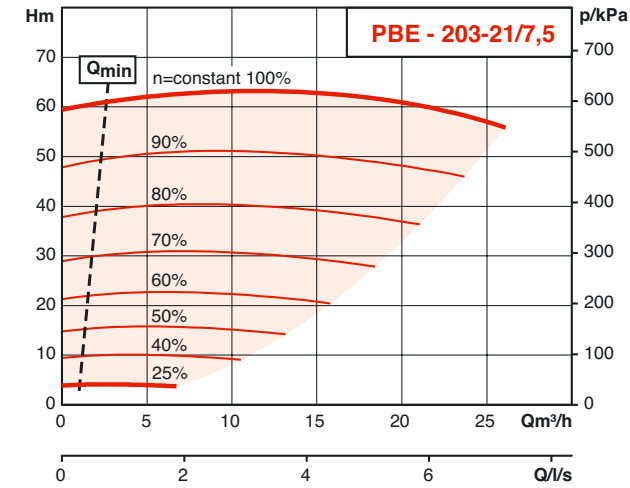



PERFORMANCES HYDRAULIQUES

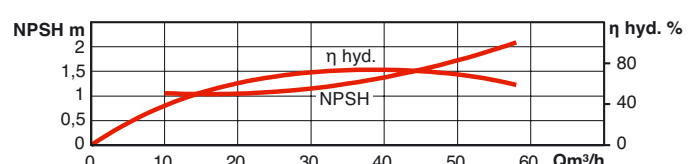
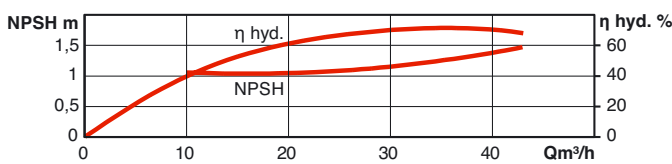
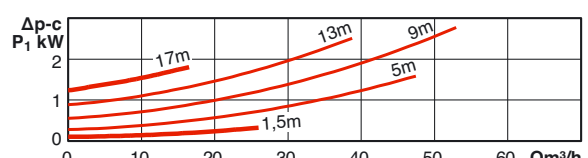
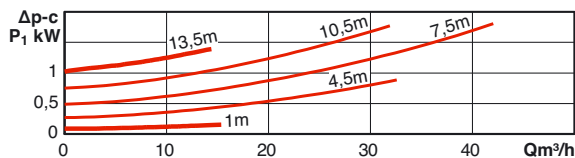
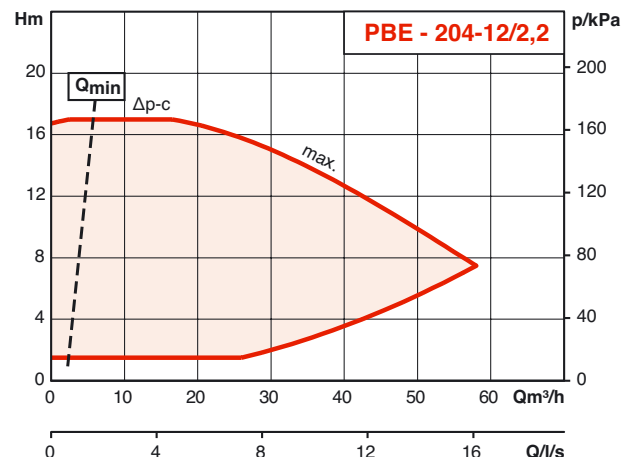
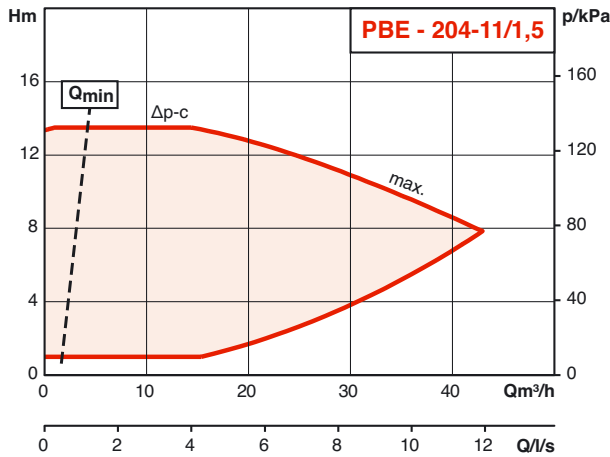
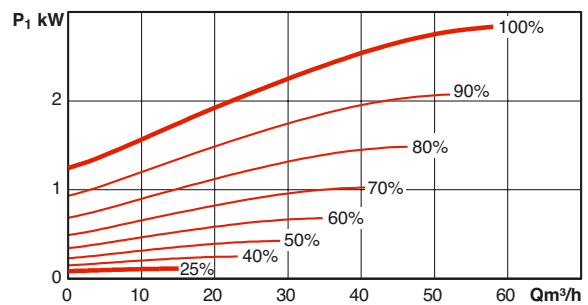
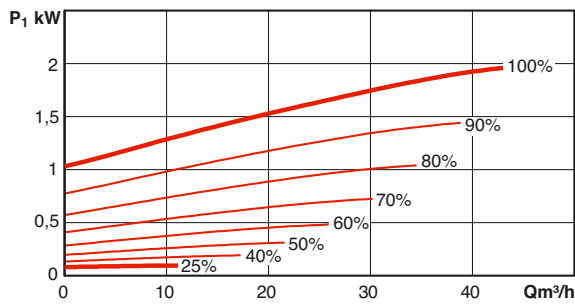
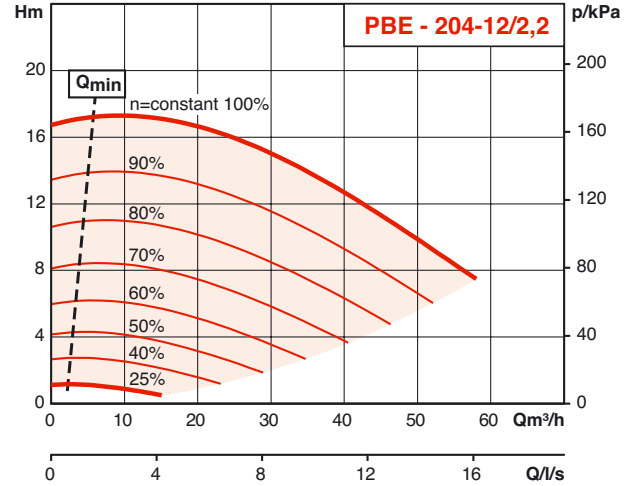
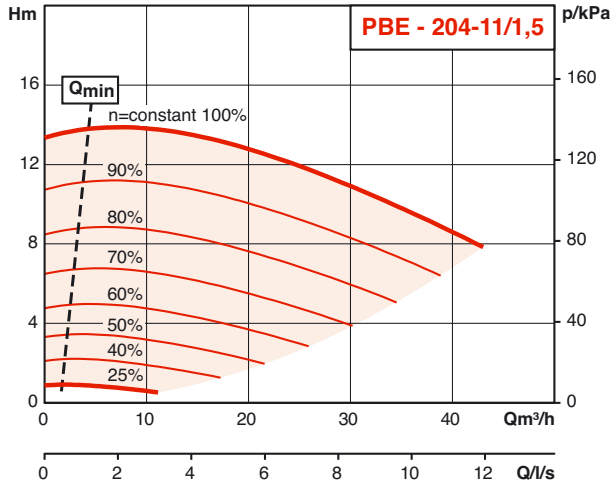

Génie climatique  
Pompes à rotor sec

# PBE

## PERFORMANCES HYDRAULIQUES

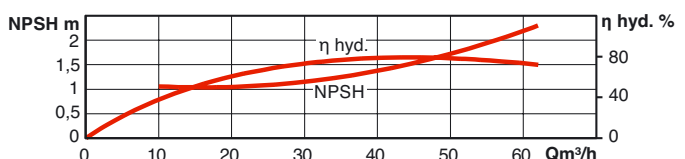
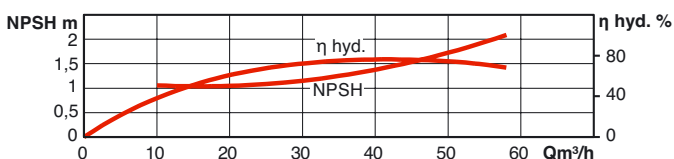
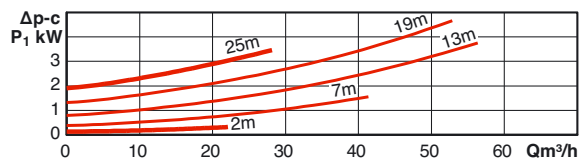
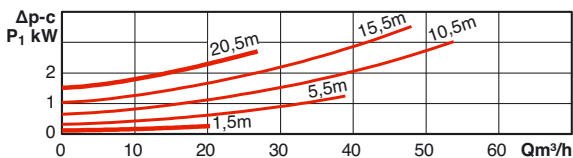
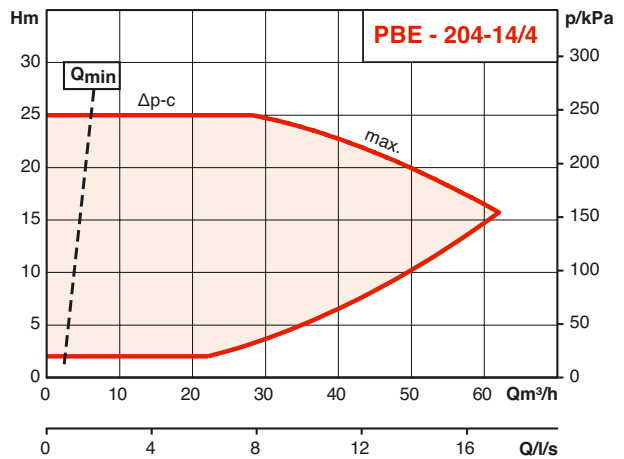
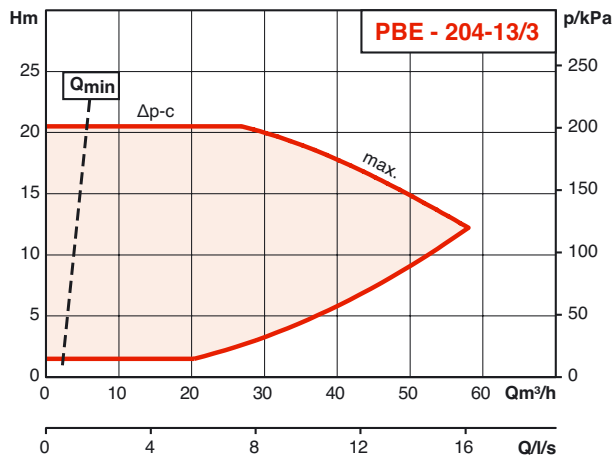
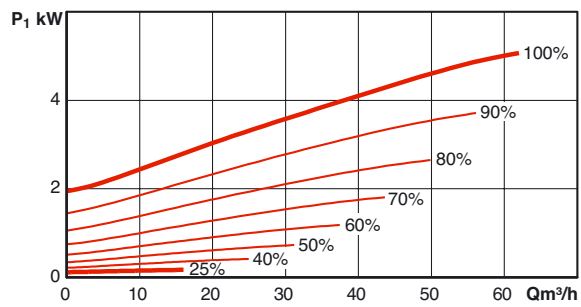
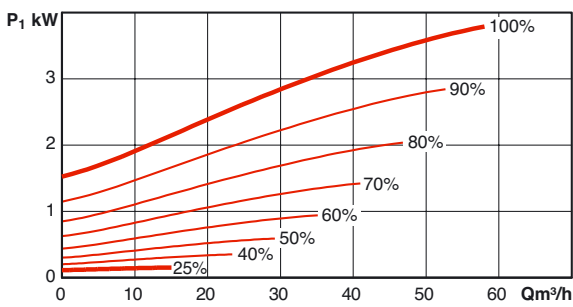
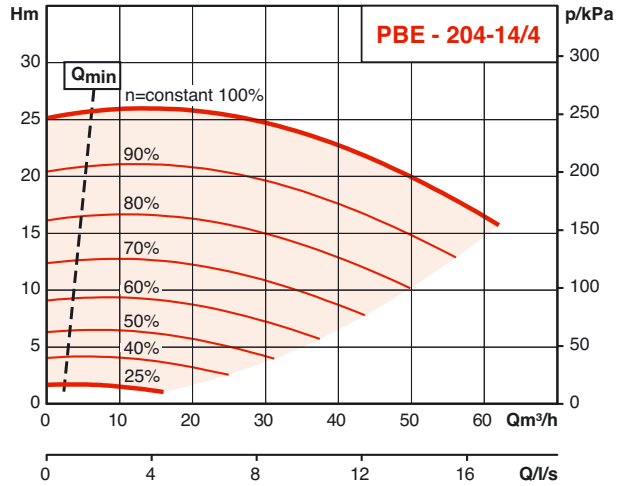
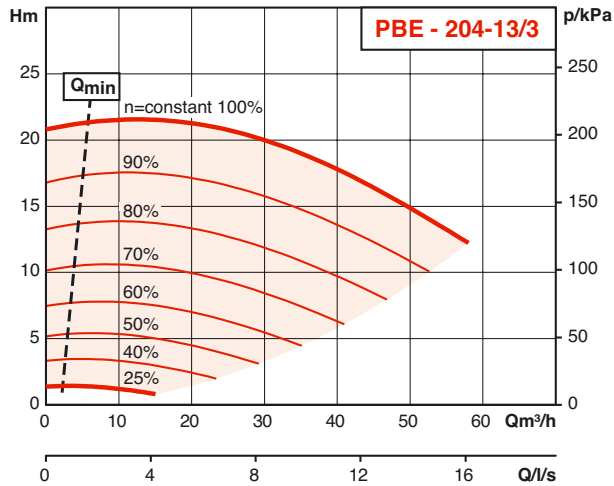

PERFORMANCES HYDRAULIQUES

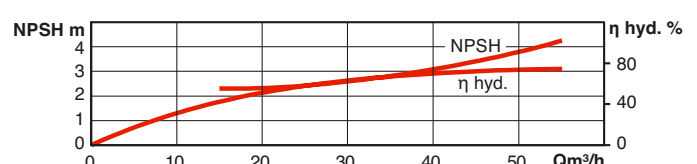
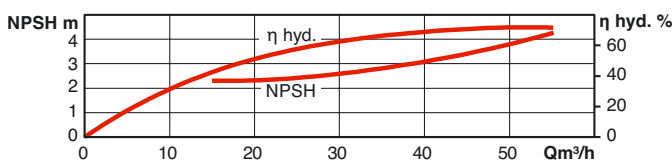
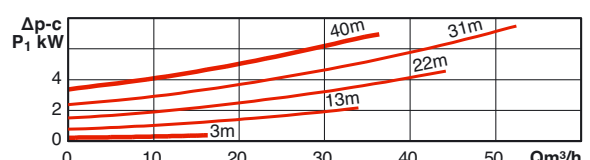
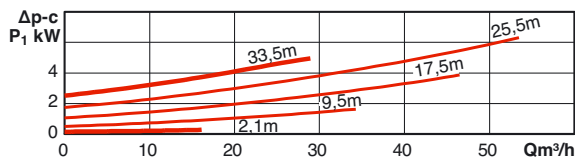
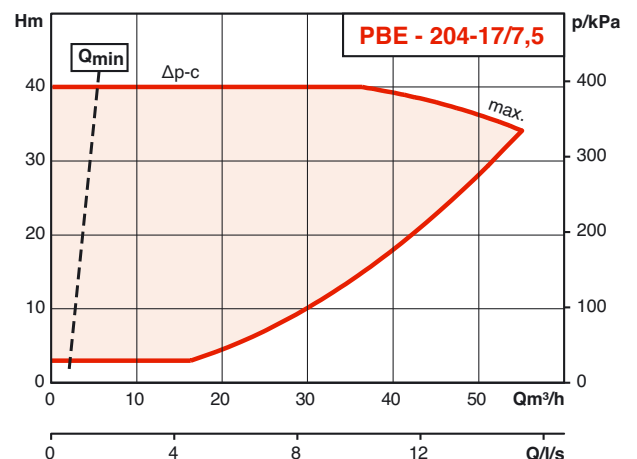
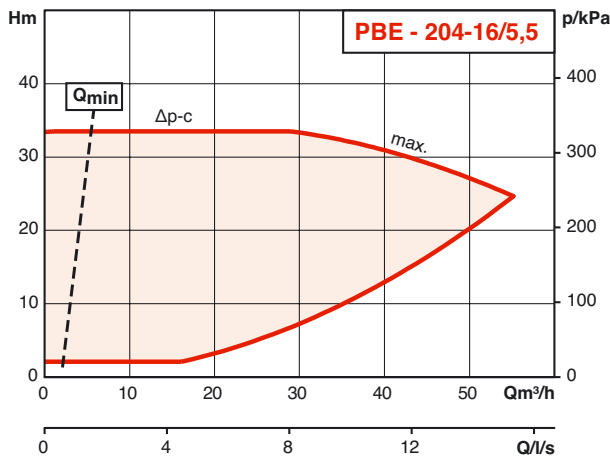
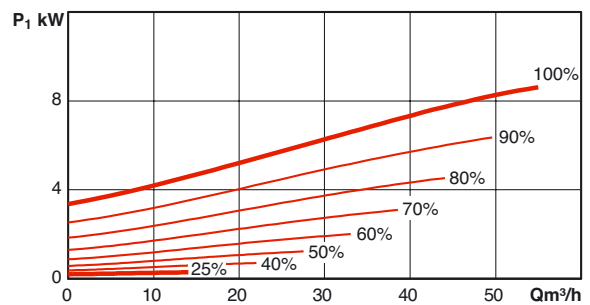
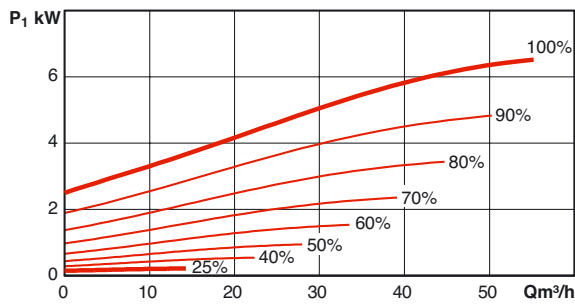
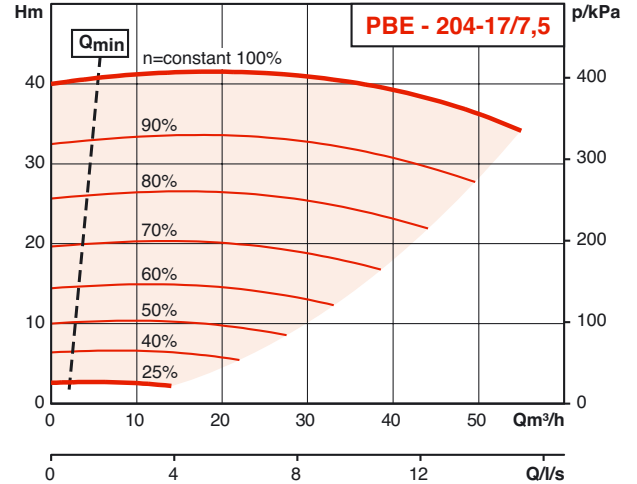
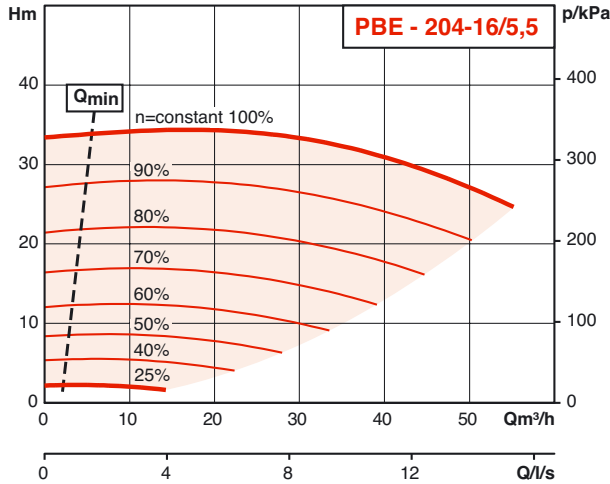

Génie climatique  
Pompes à rotor sec

# PBE

## PERFORMANCES HYDRAULIQUES

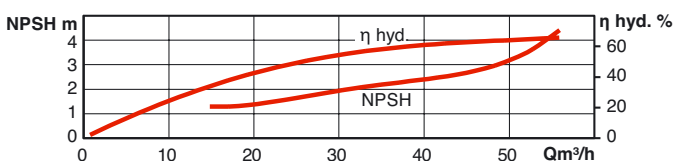
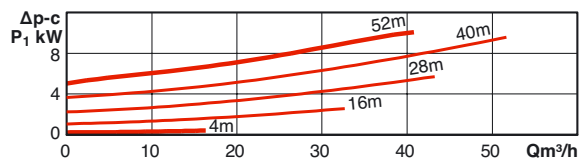
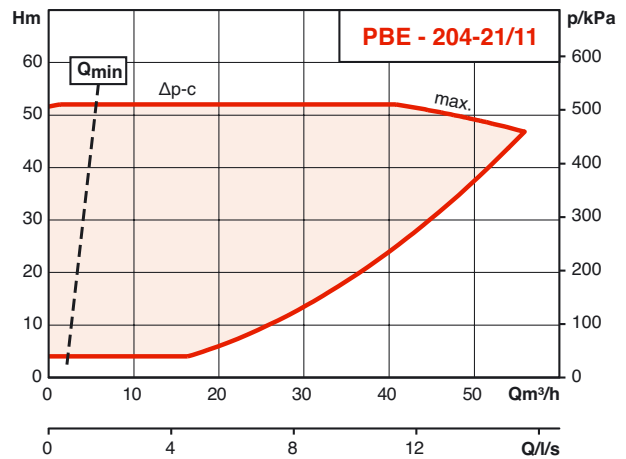
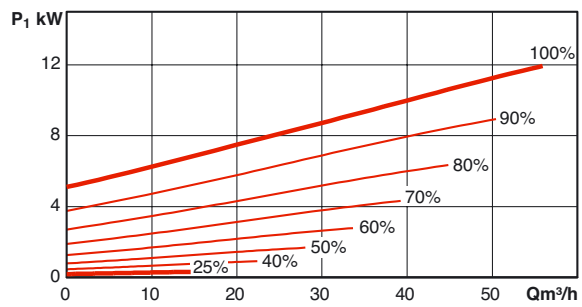
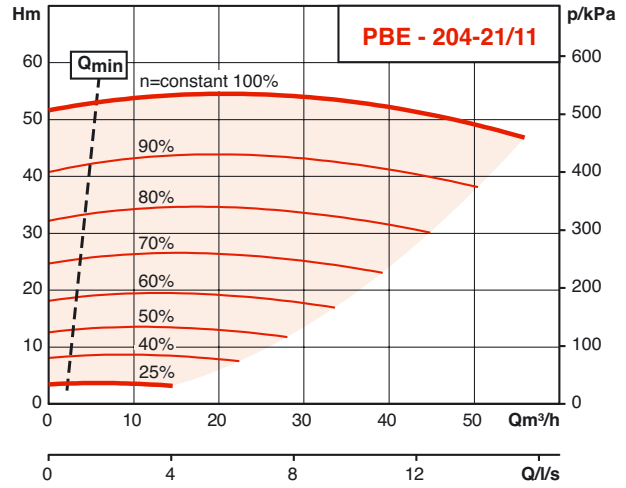
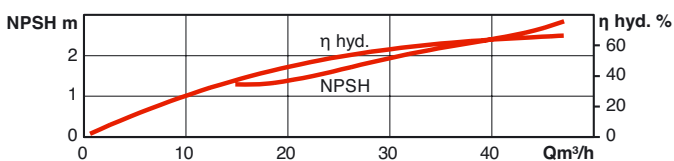
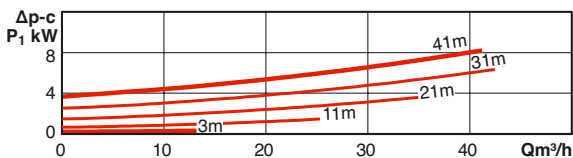
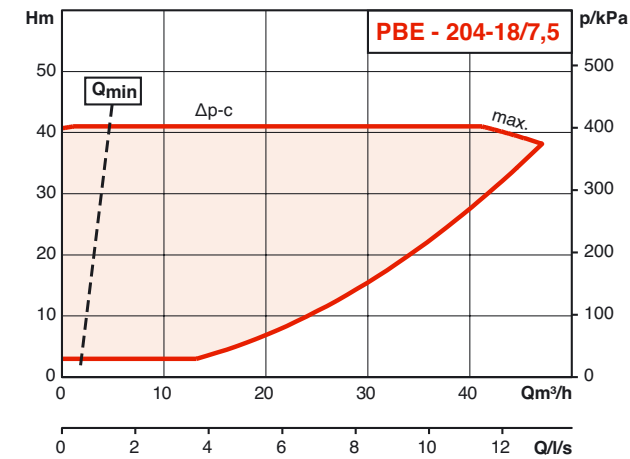
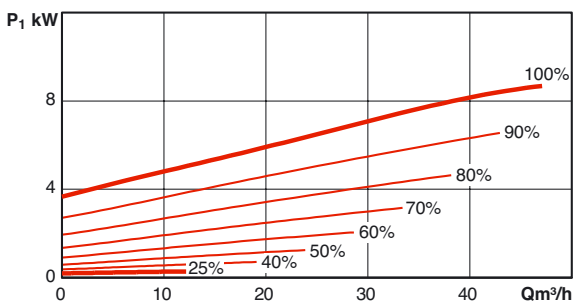
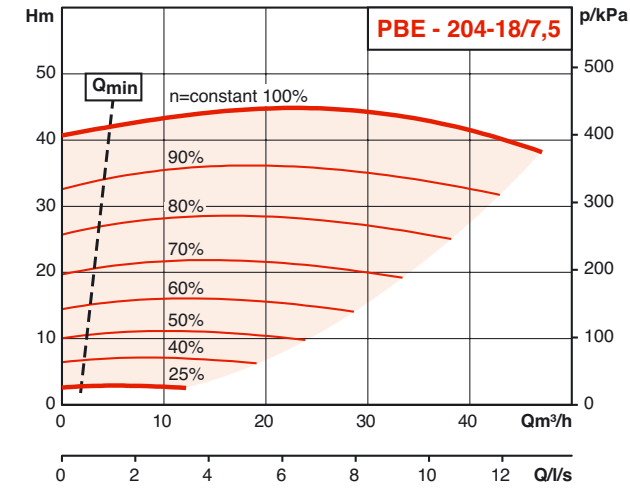

**PERFORMANCES HYDRAULIQUES**

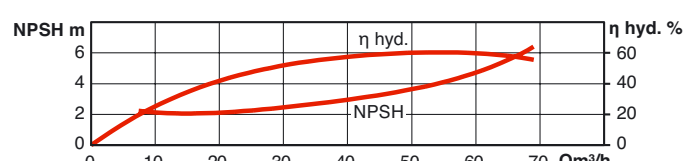
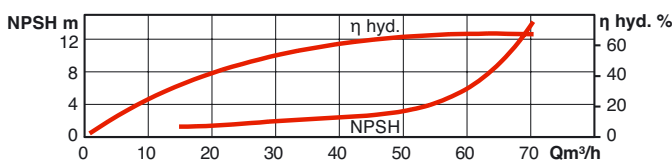
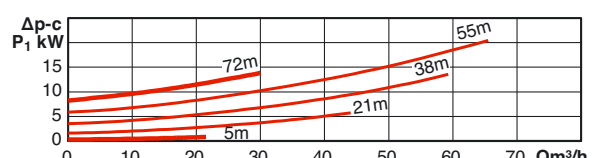
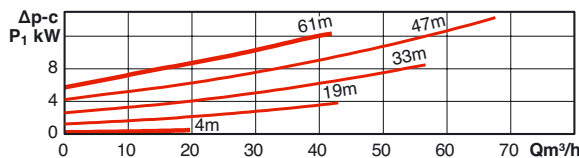
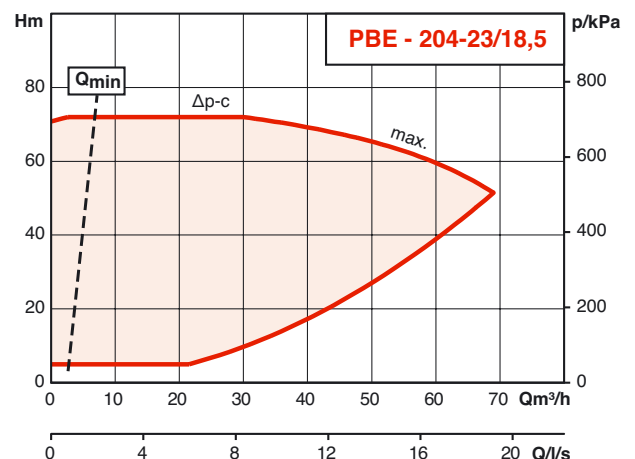
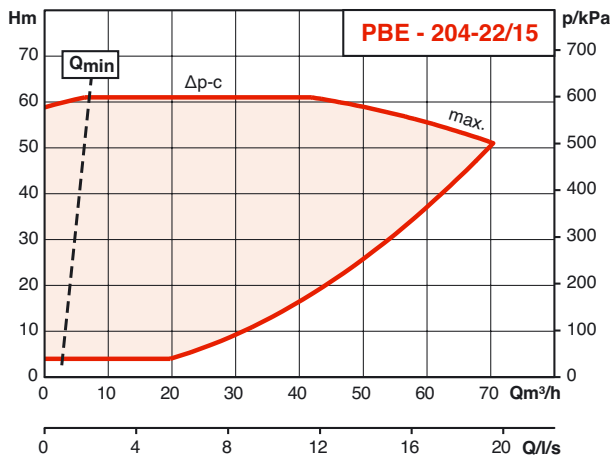
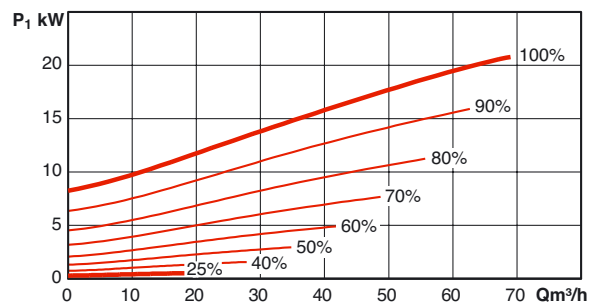
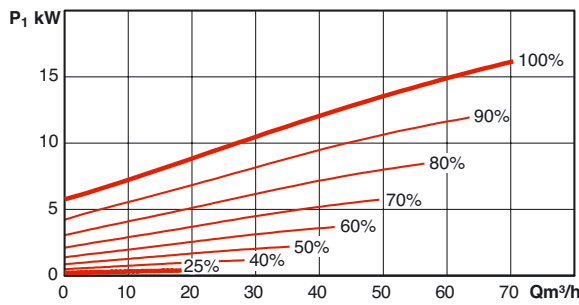
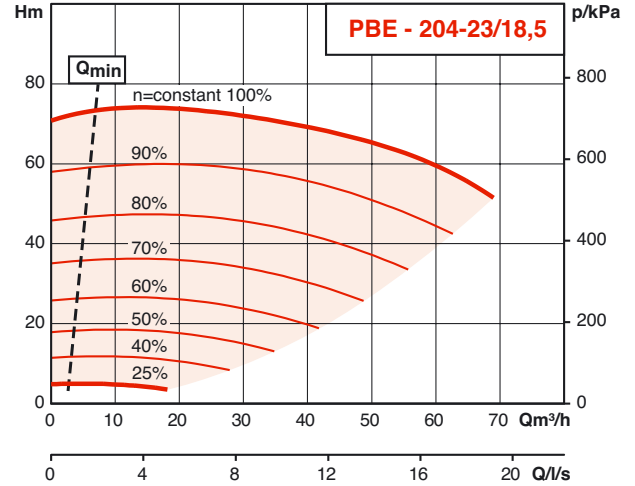
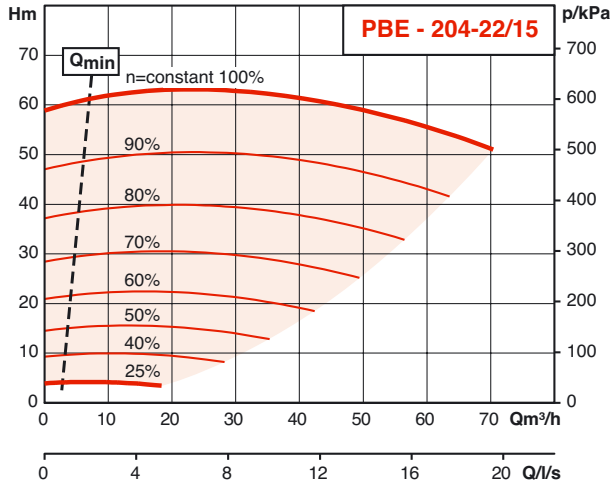

Génie climatique  
Pompes à rotor sec

# PBE

## PERFORMANCES HYDRAULIQUES

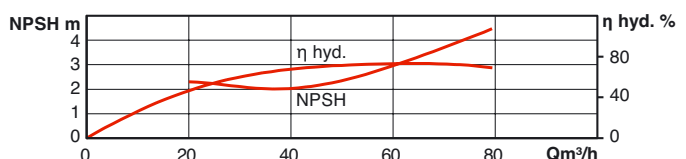
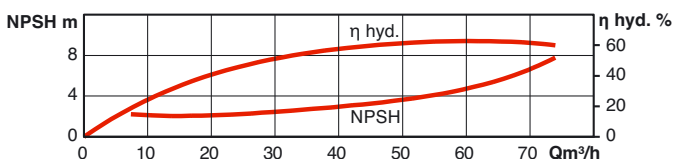
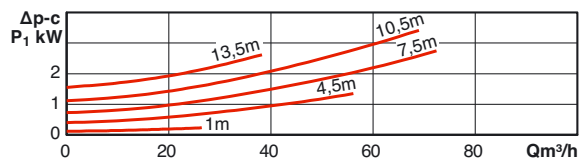
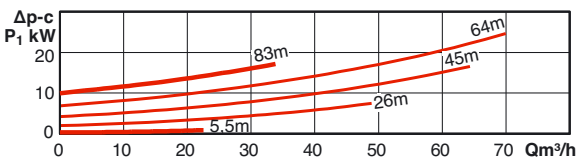
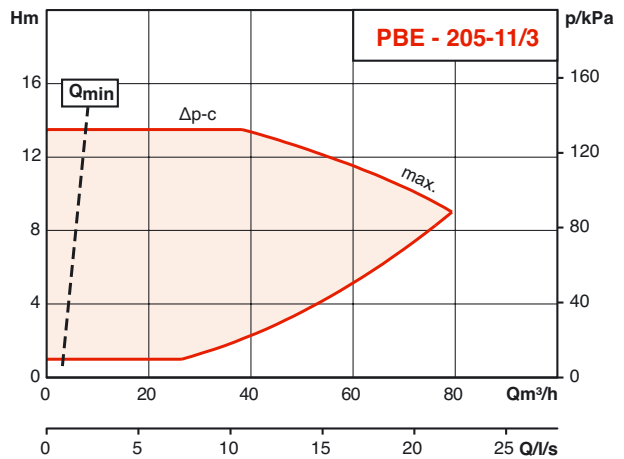
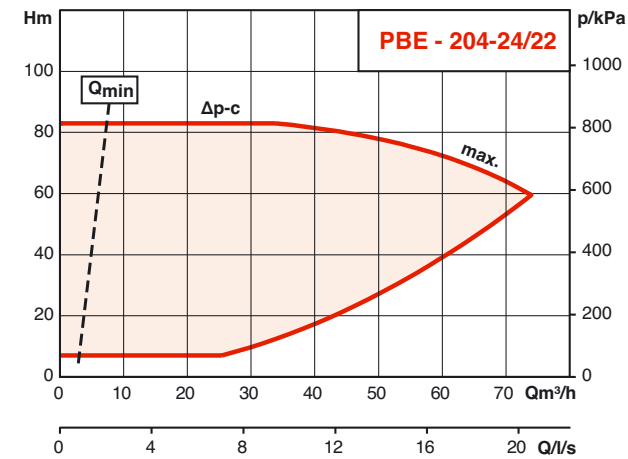
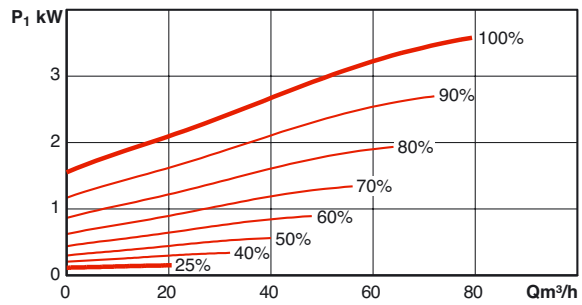
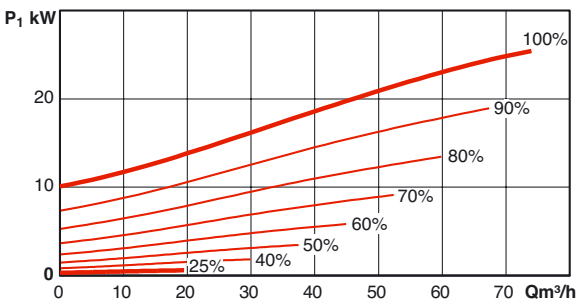
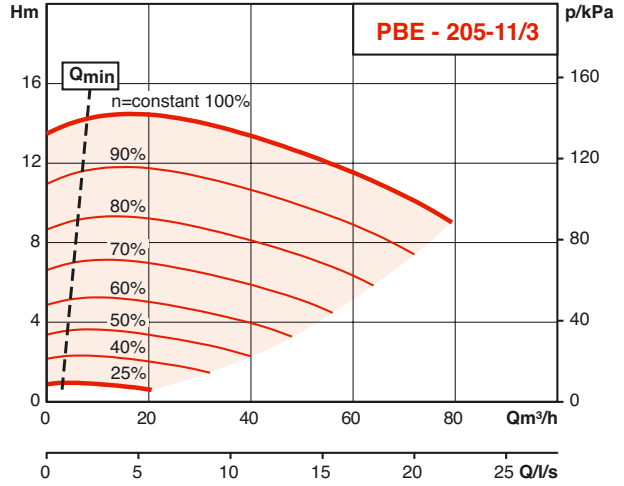
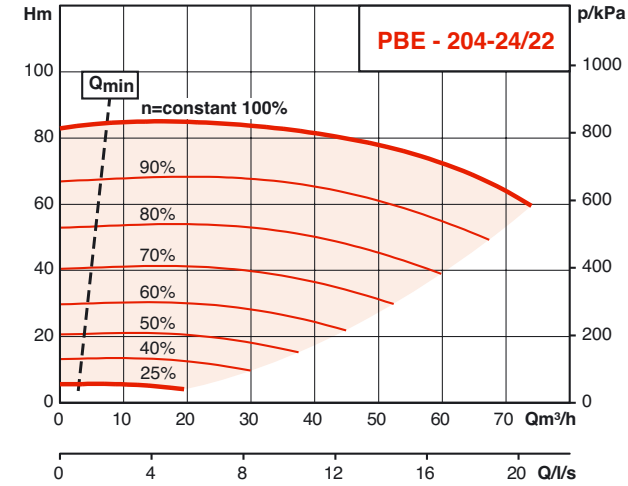

PERFORMANCES HYDRAULIQUES

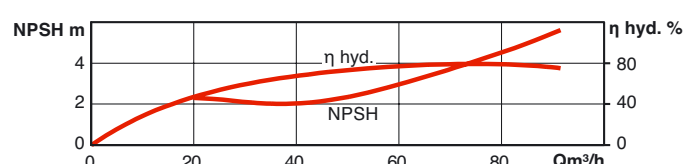
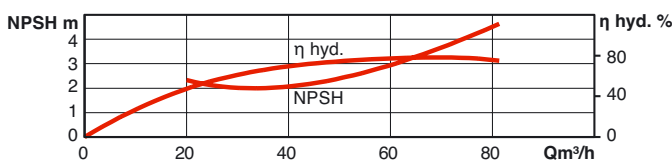
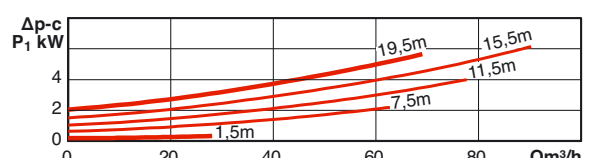
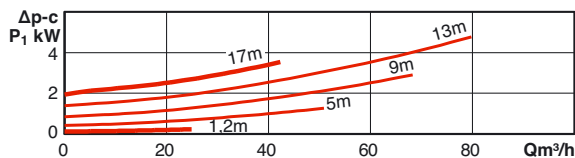
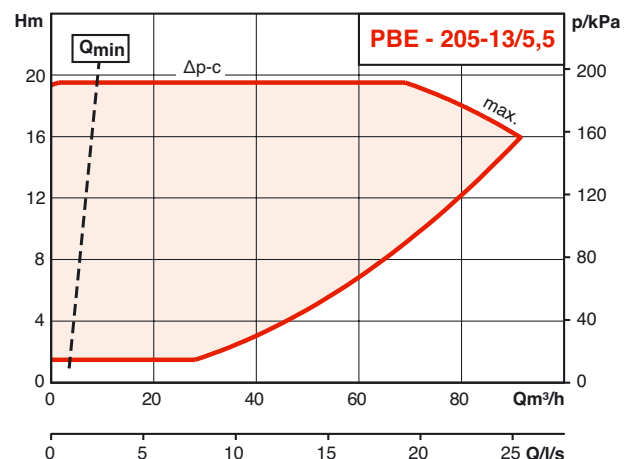
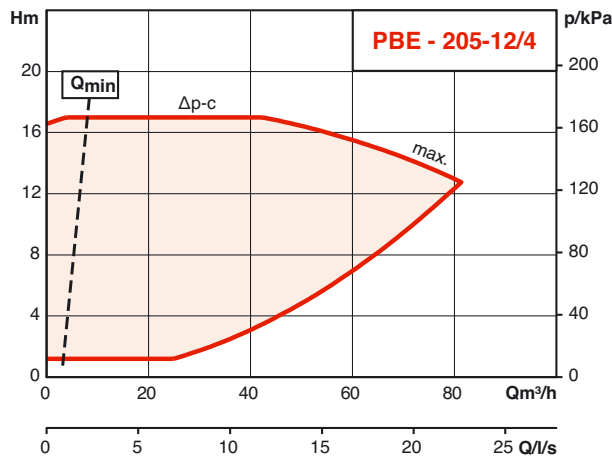
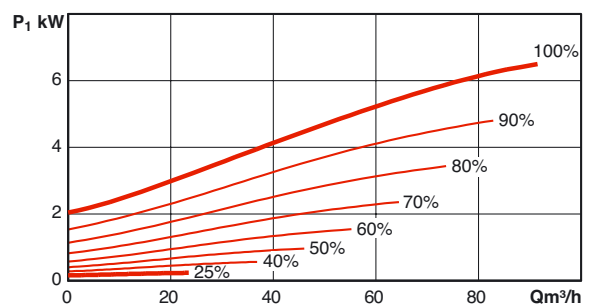
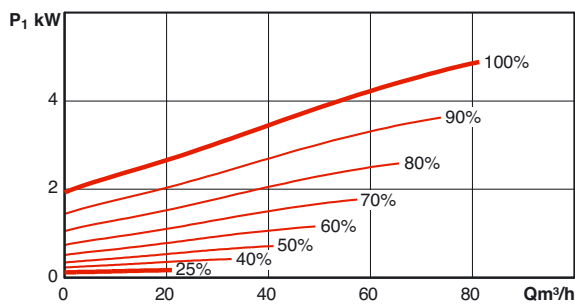
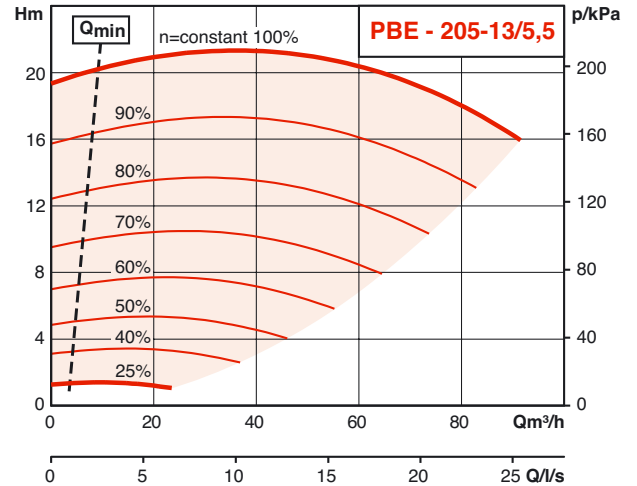
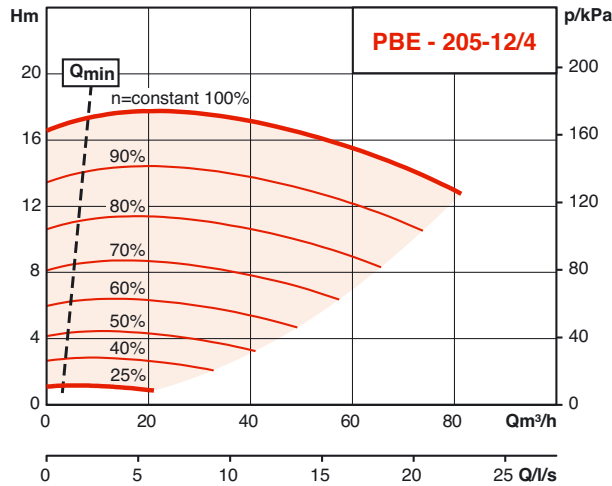

Génie climatique  
Pompes à rotor sec

# PBE

## PERFORMANCES HYDRAULIQUES

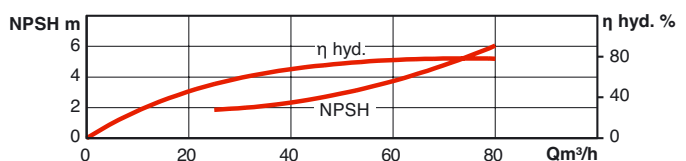
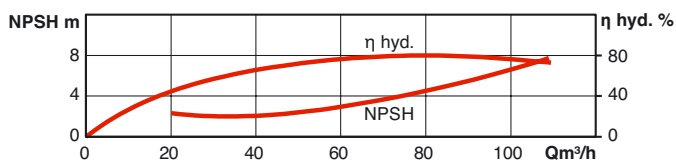
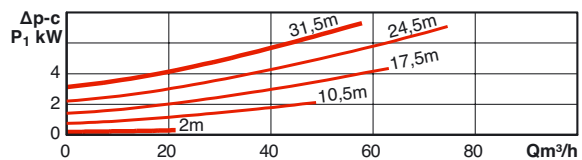
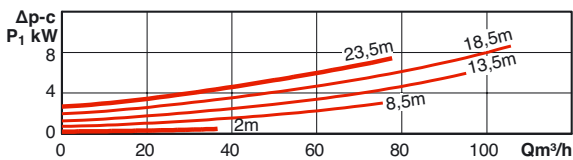
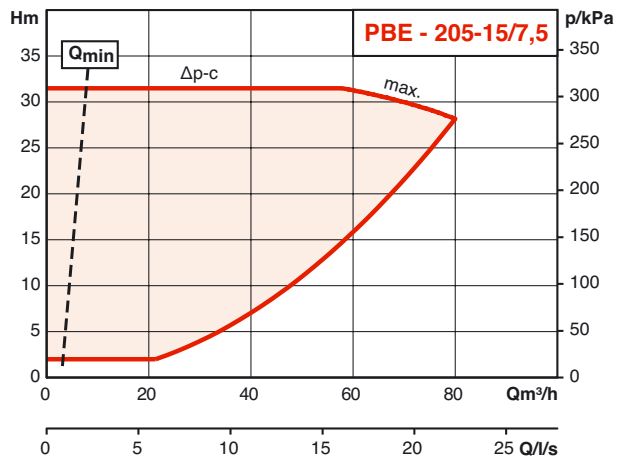
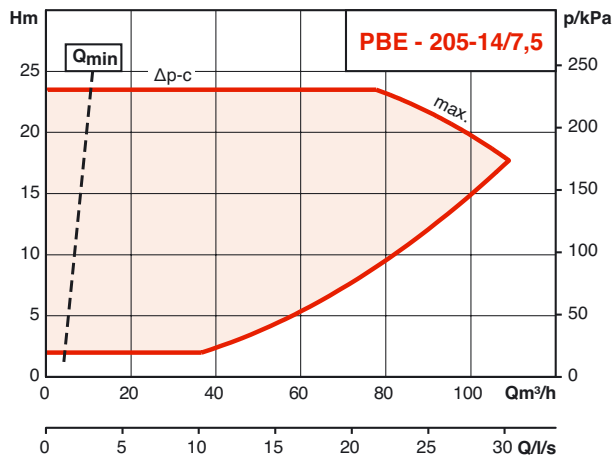
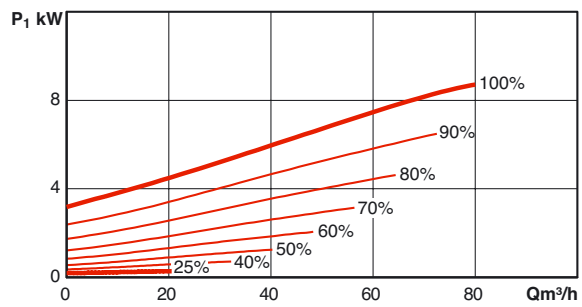
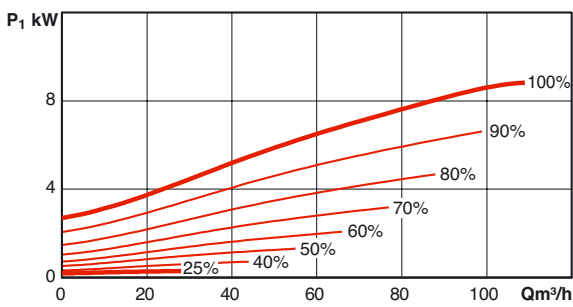
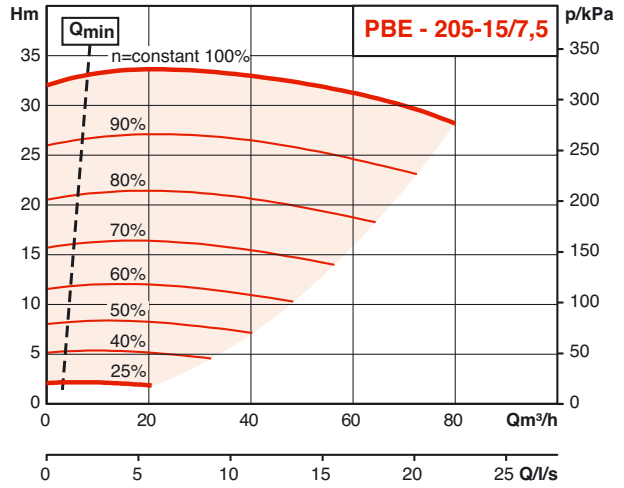
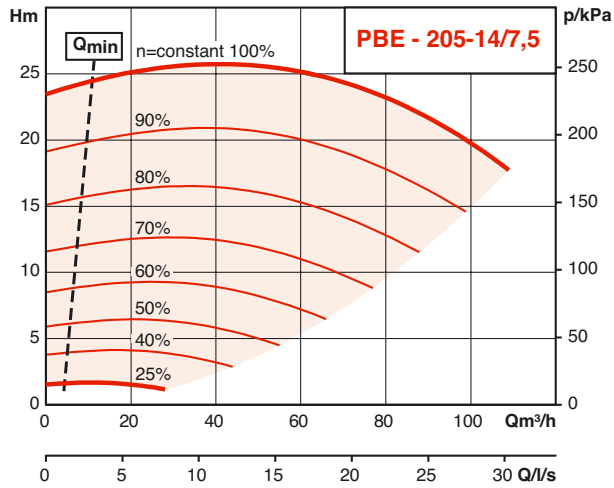



**PERFORMANCES HYDRAULIQUES**

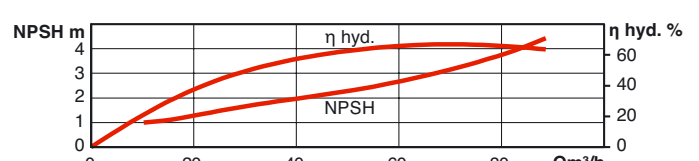
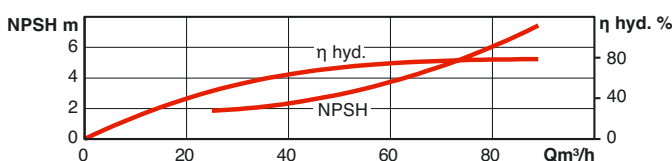
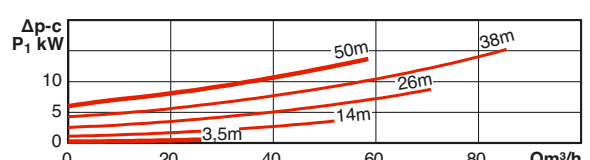
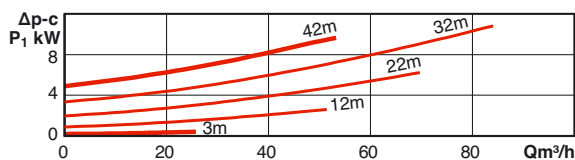
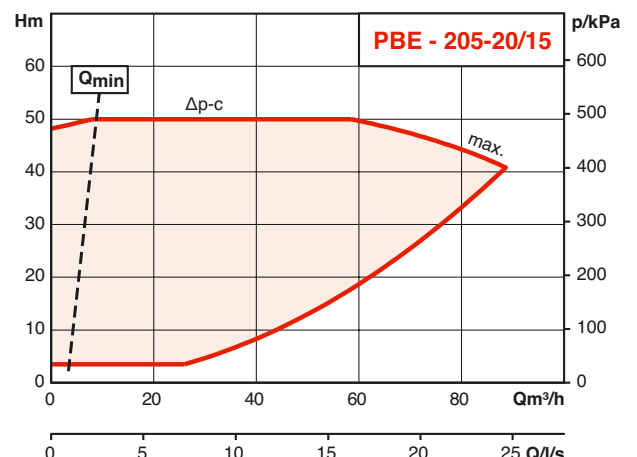
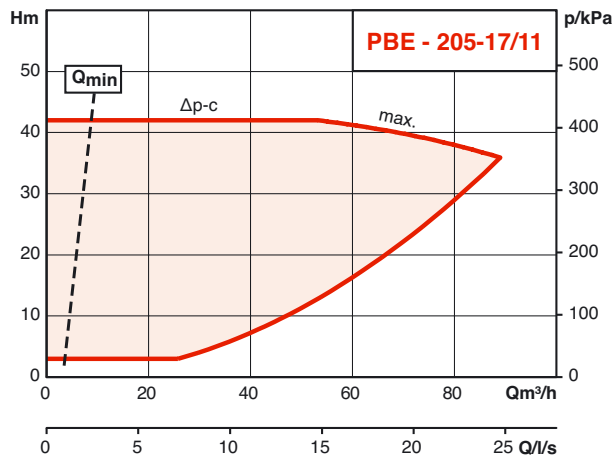
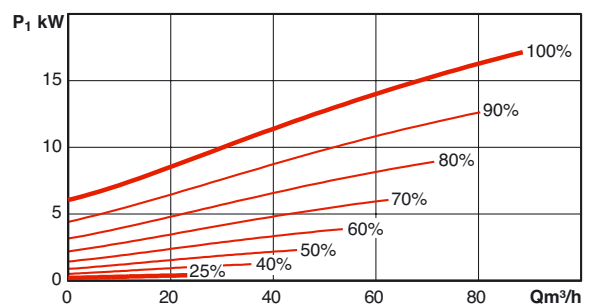
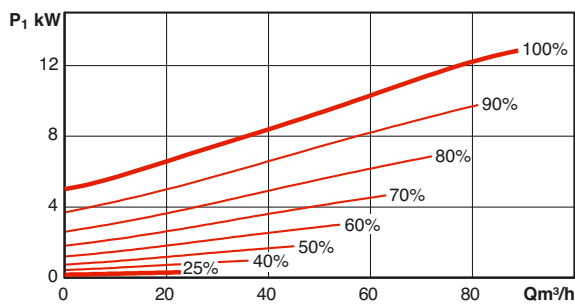
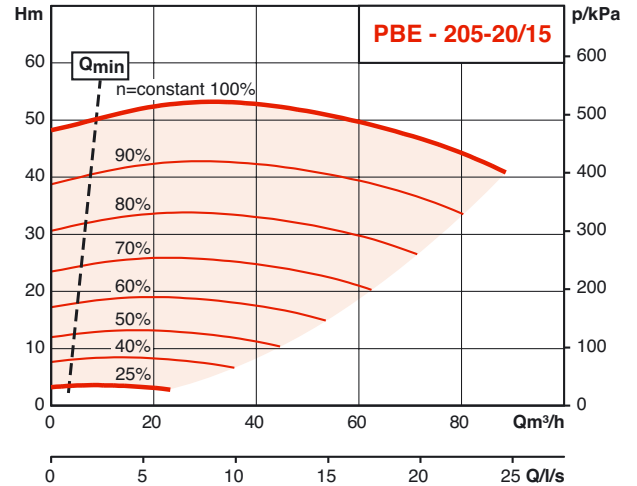
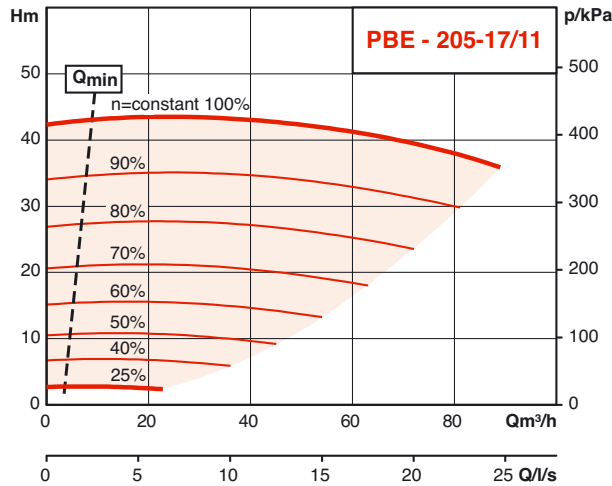

Génie climatique  
Pompes à rotor sec

# PBE

## PERFORMANCES HYDRAULIQUES

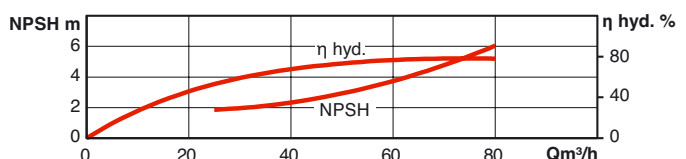
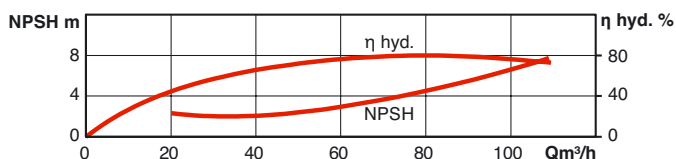
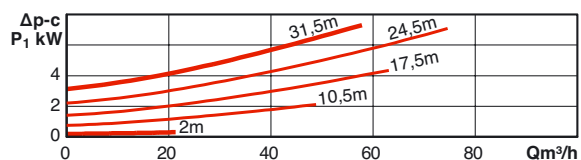
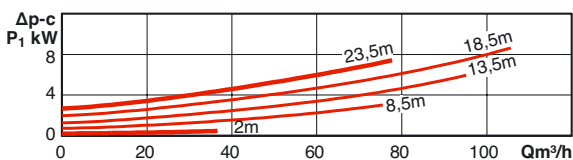
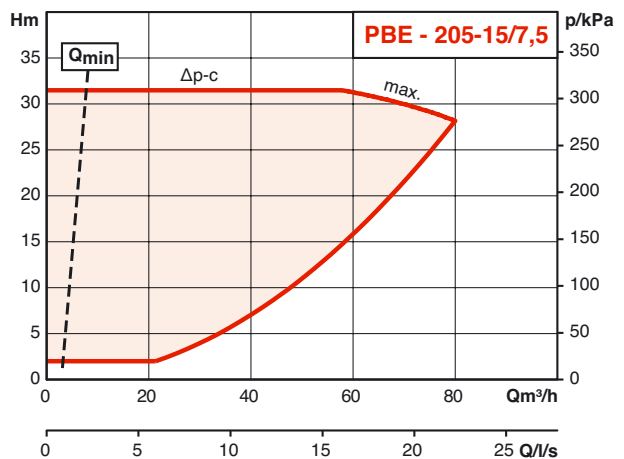
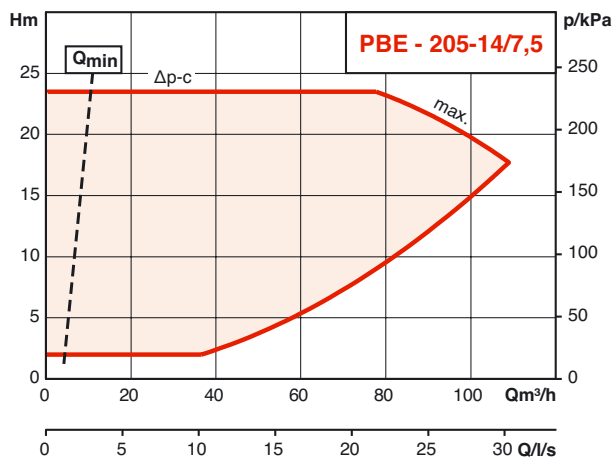
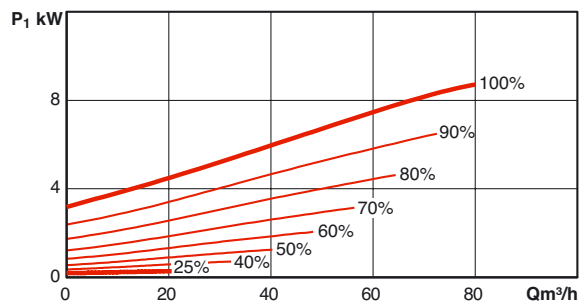
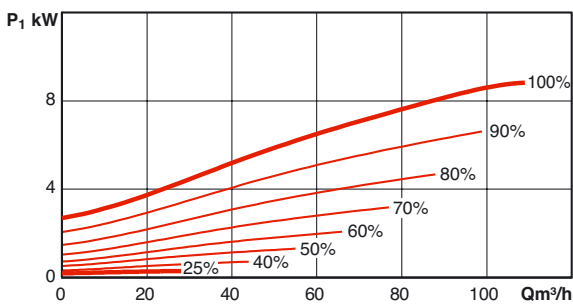
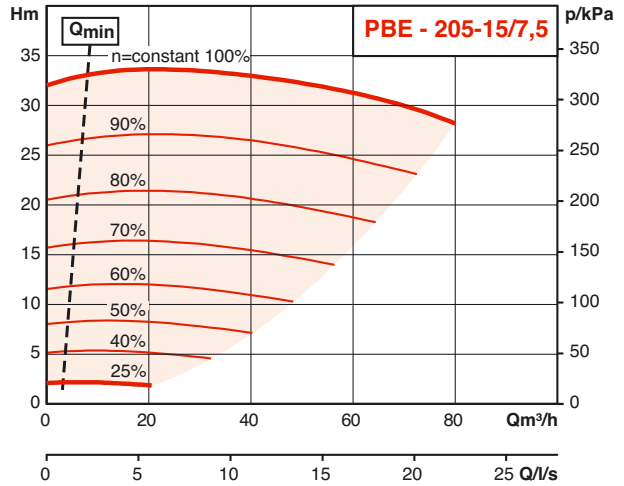
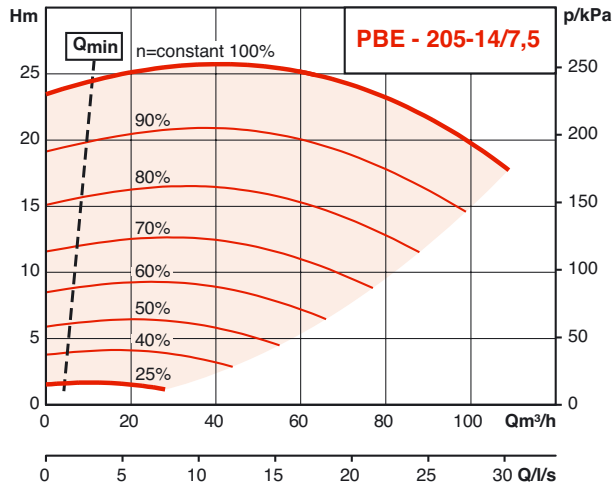

**PERFORMANCES HYDRAULIQUES**

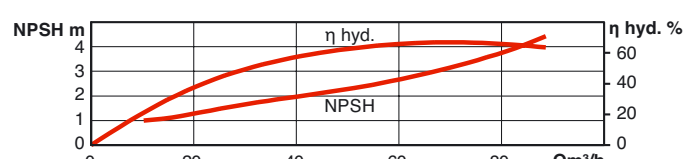
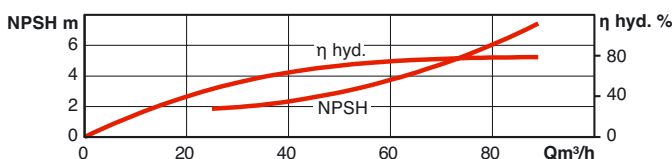
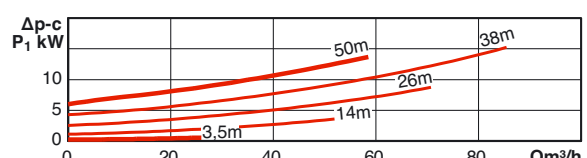
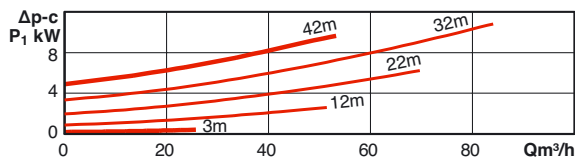
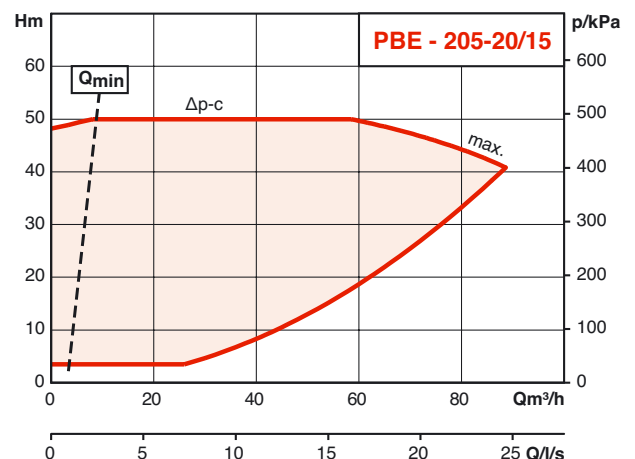
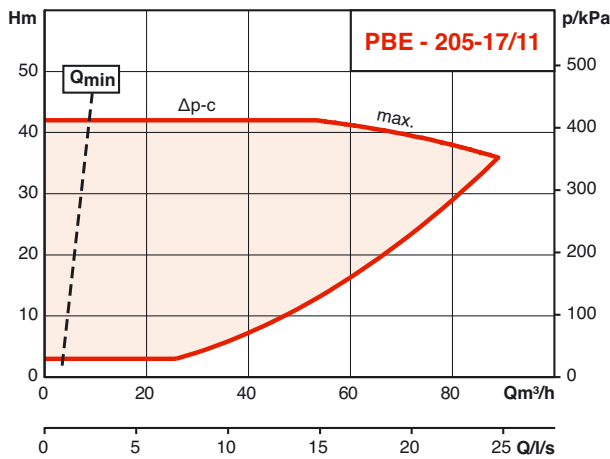
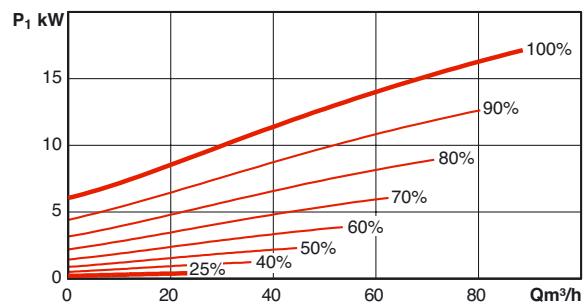
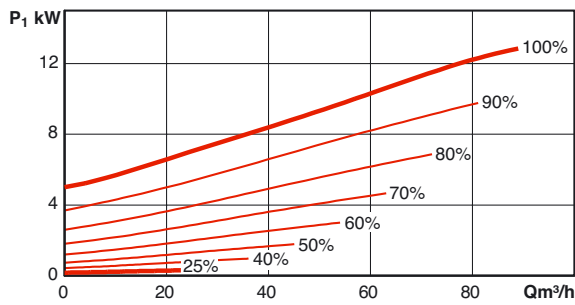
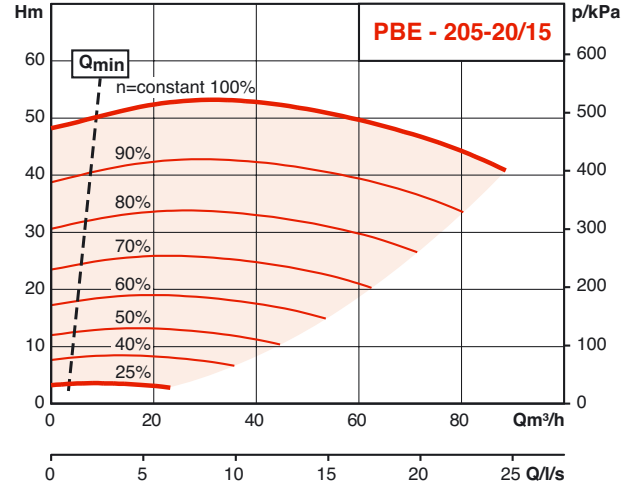
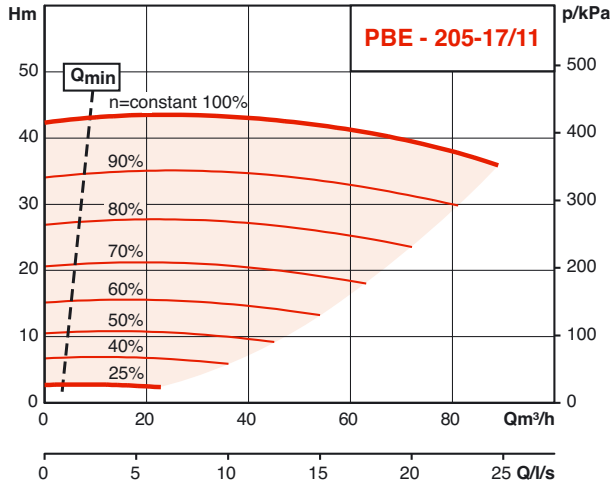

Génie climatique  
Pompes à rotor sec

# PBE

## PERFORMANCES HYDRAULIQUES

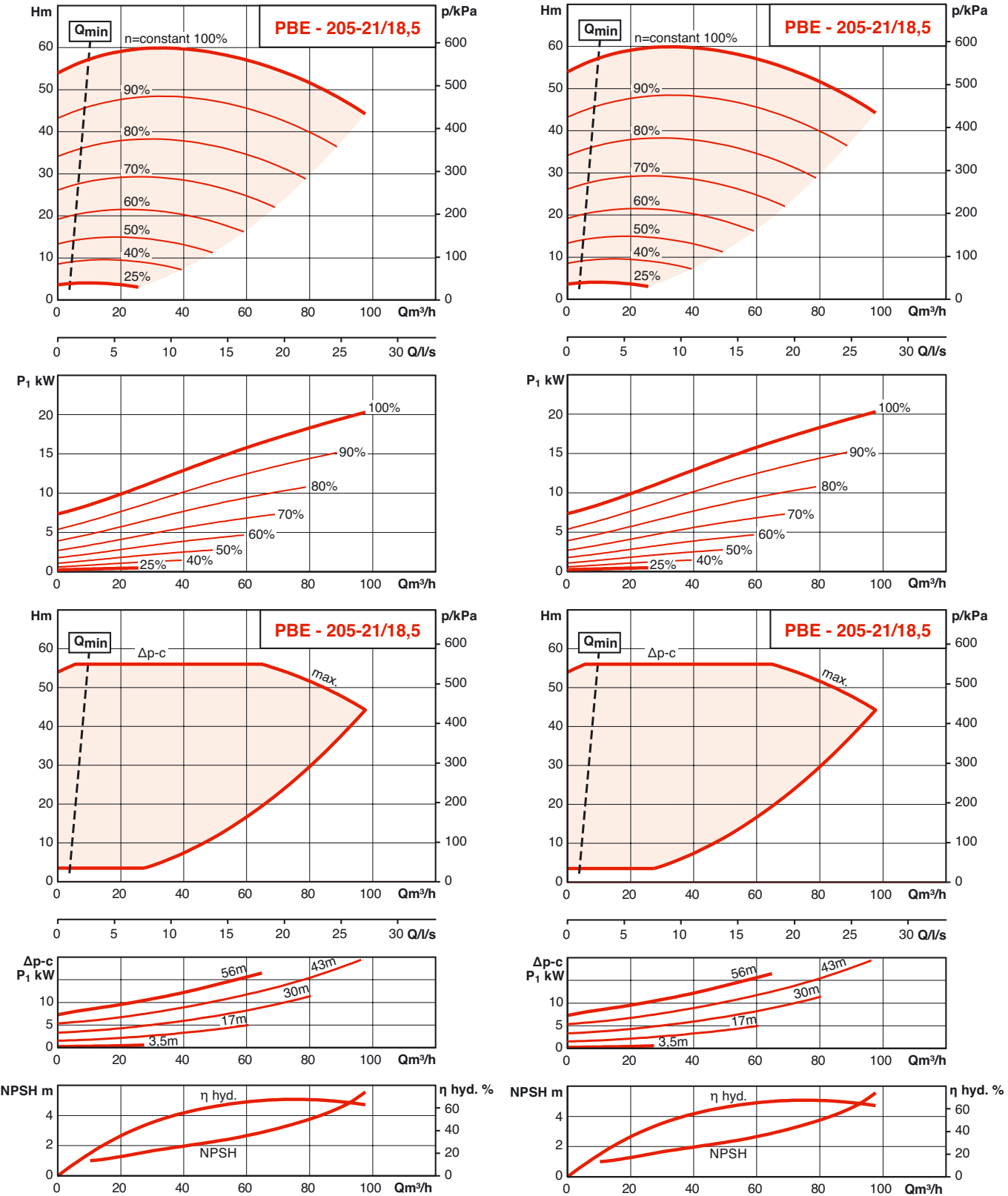

**PERFORMANCES HYDRAULIQUES**

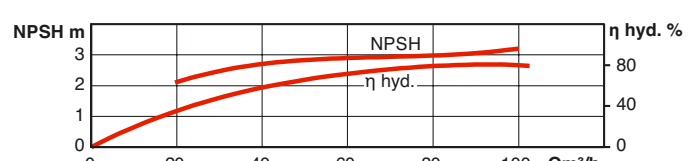
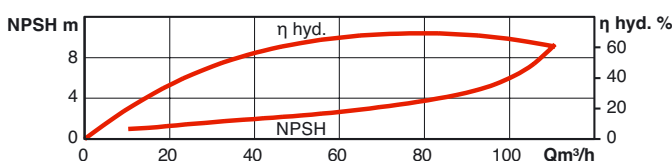
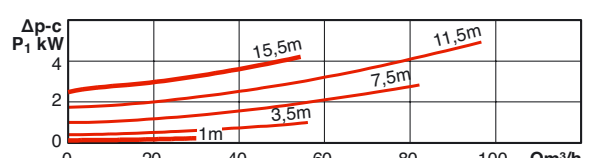
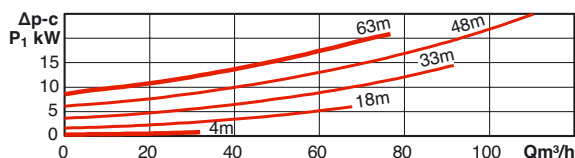
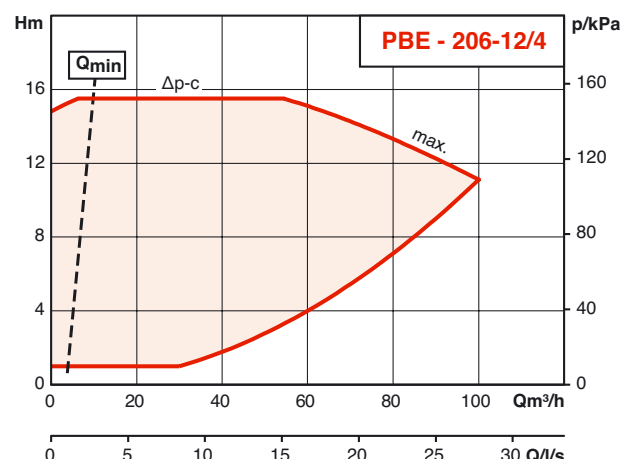
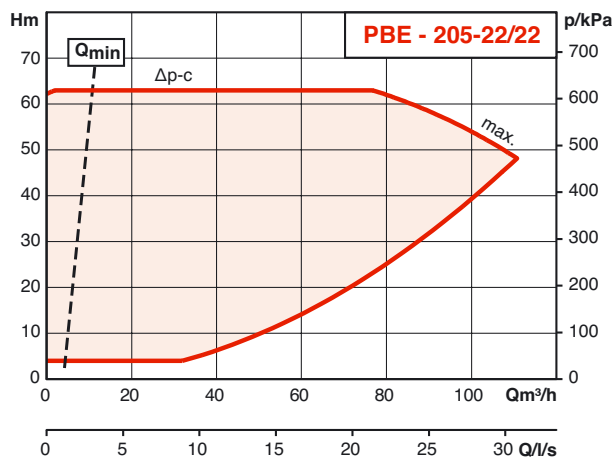
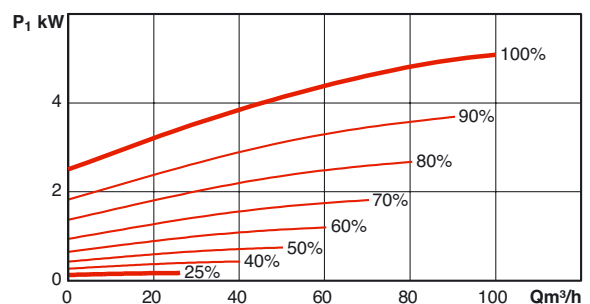
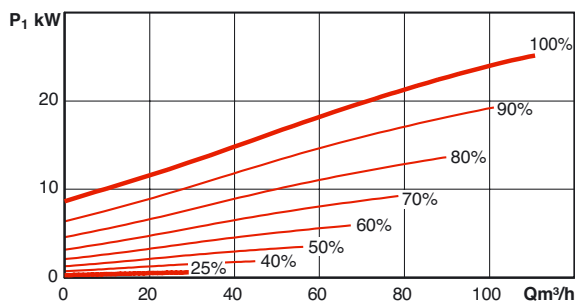
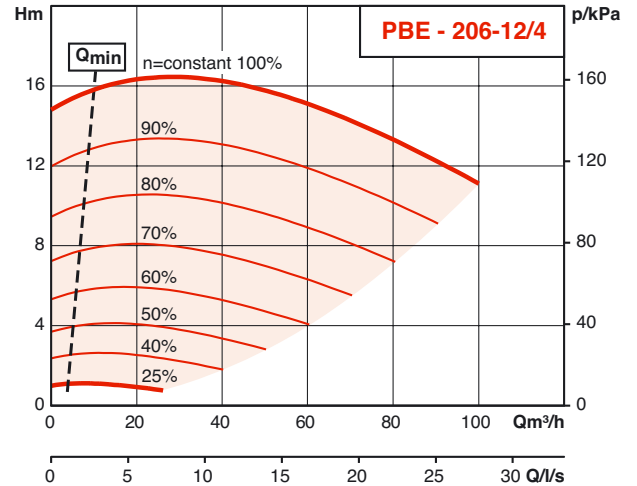
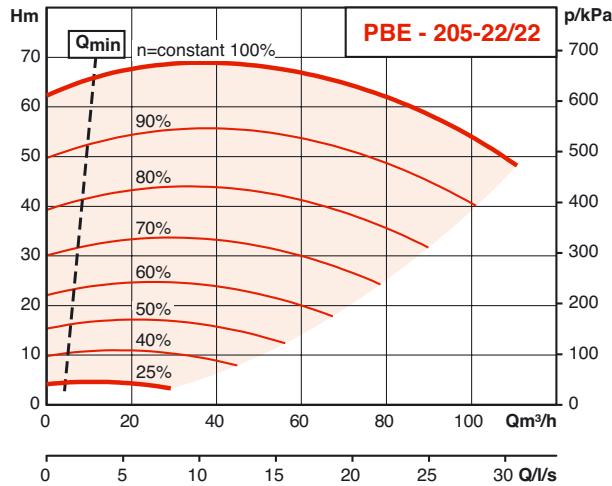

Génie climatique  
Pompes à rotor sec

# PBE

## PERFORMANCES HYDRAULIQUES

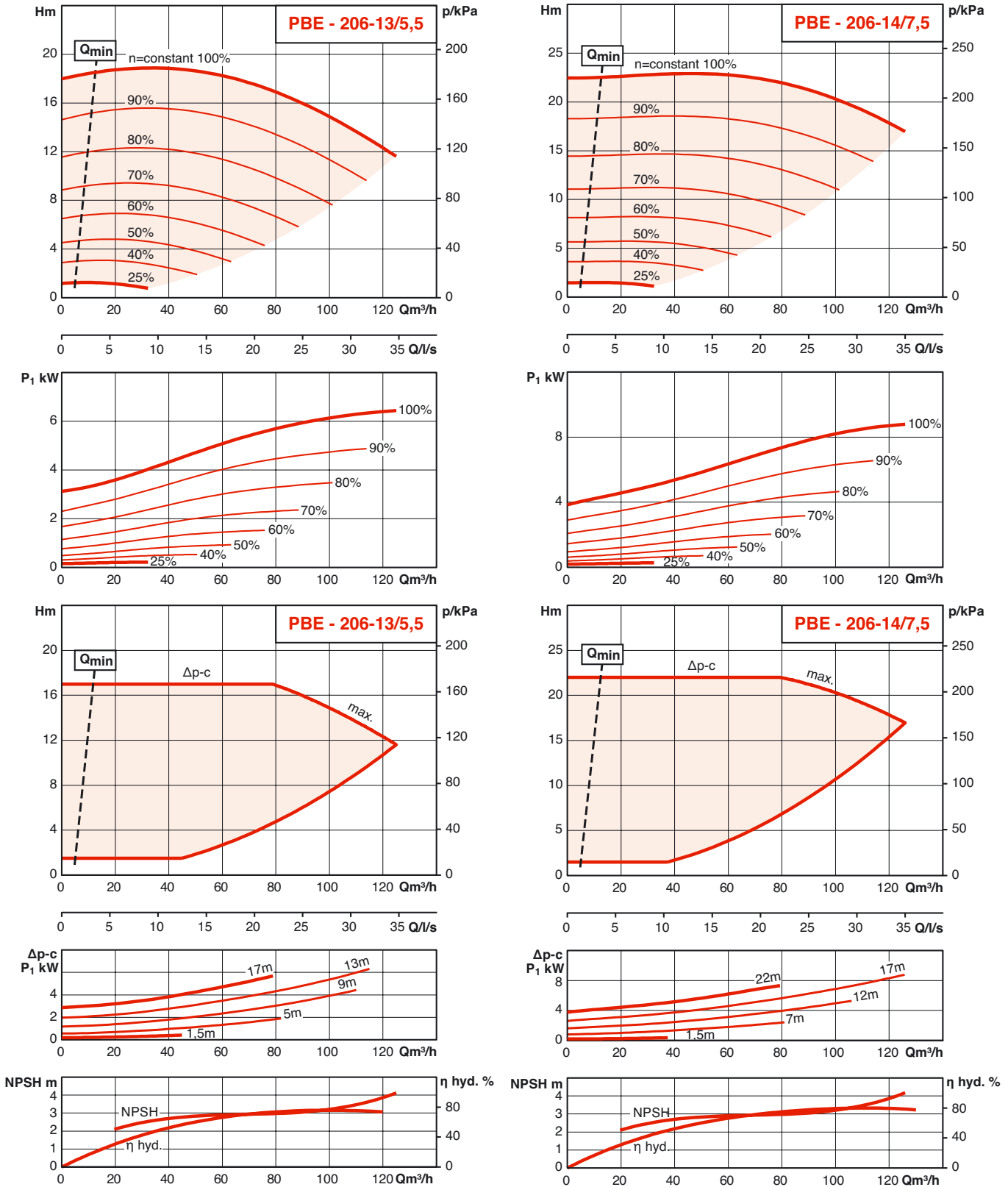

PERFORMANCES HYDRAULIQUES

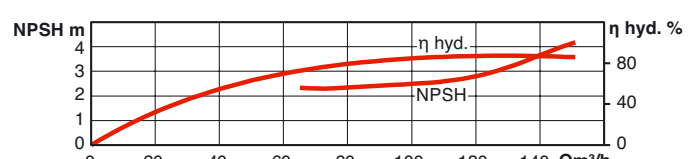
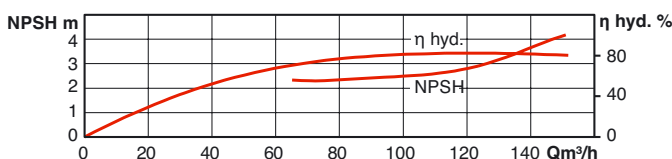
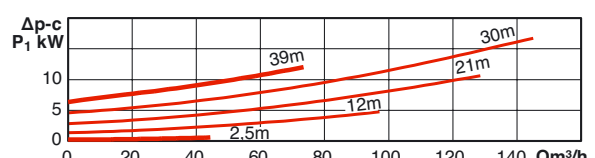
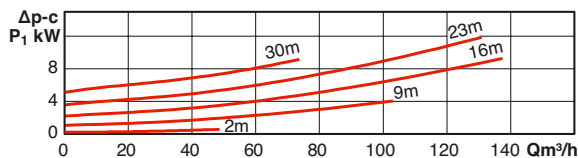
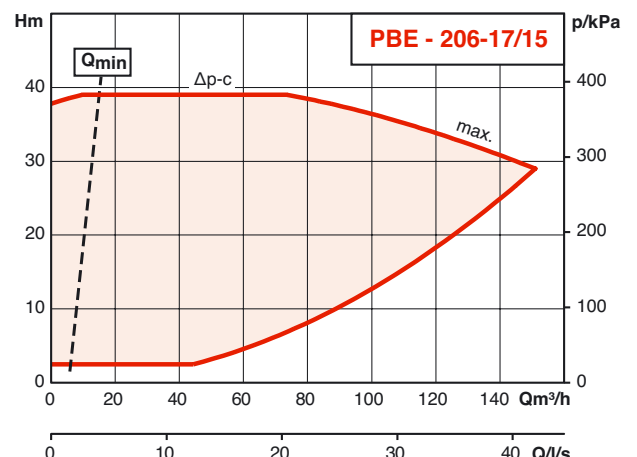
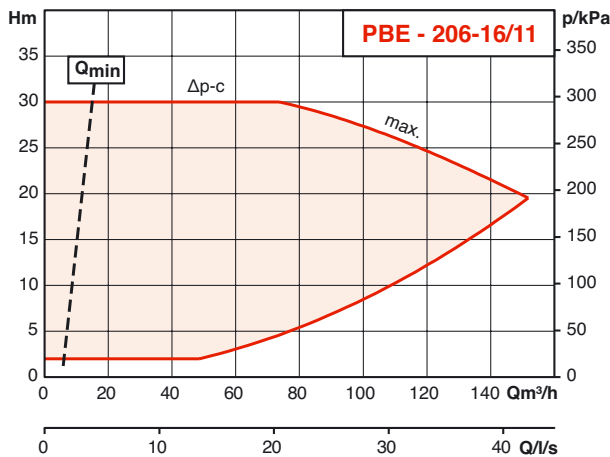
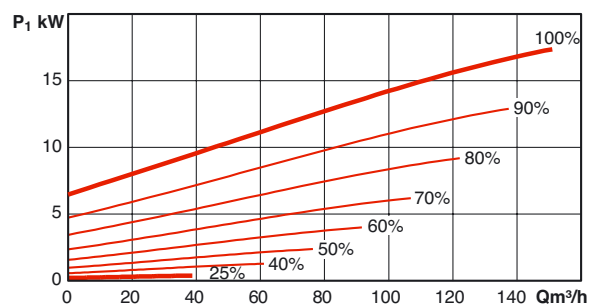
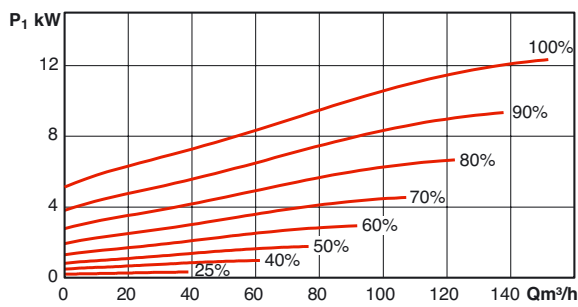
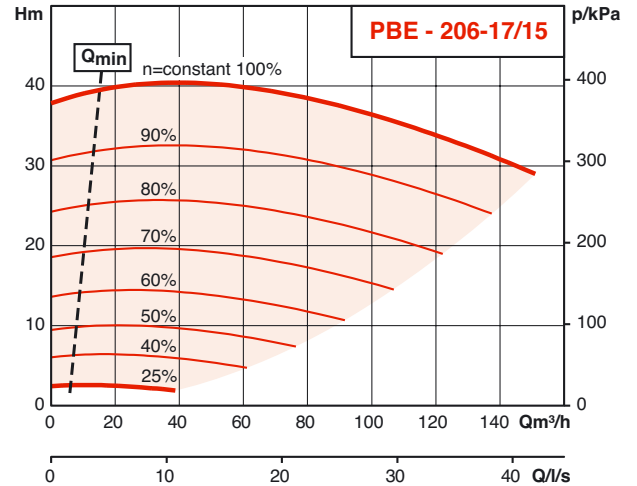
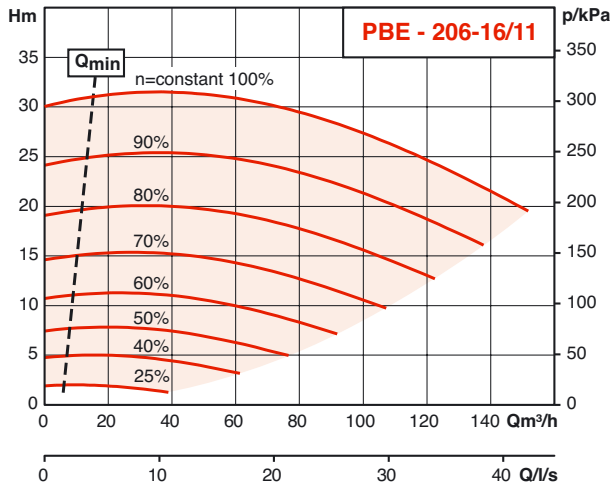

Génie climatique  
Pompes à rotor sec

# PBE

## PERFORMANCES HYDRAULIQUES

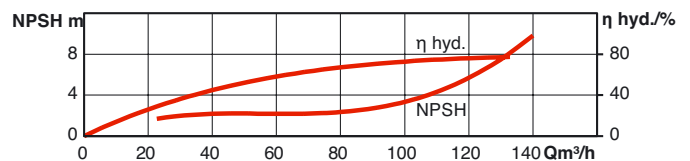
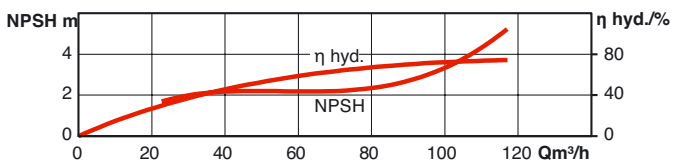
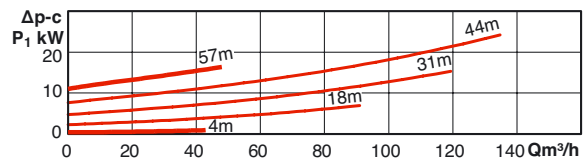
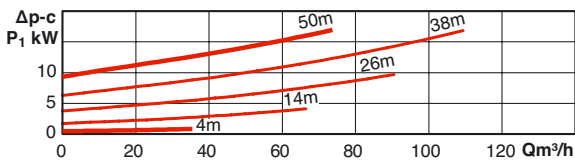
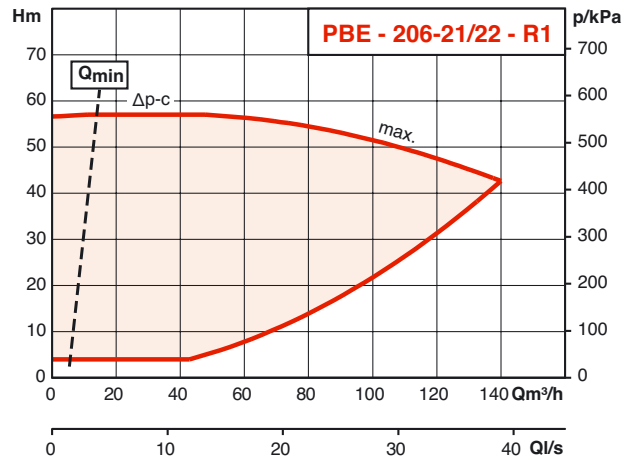
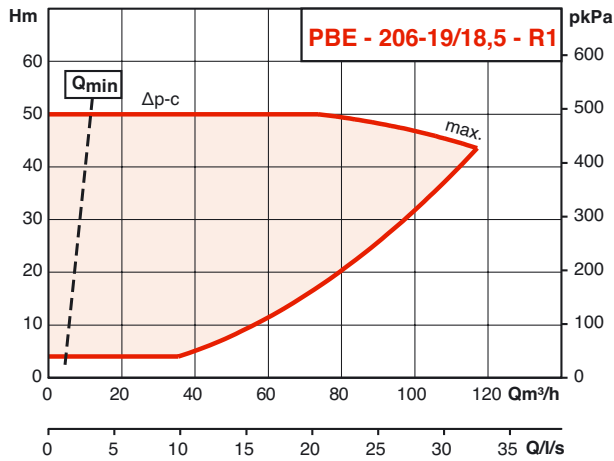
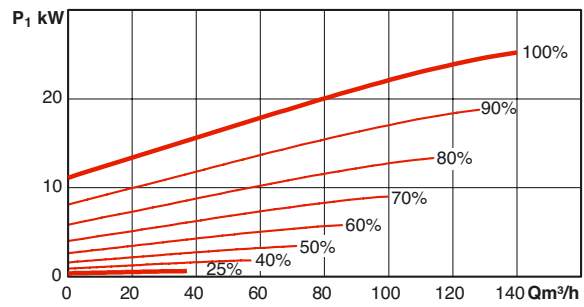
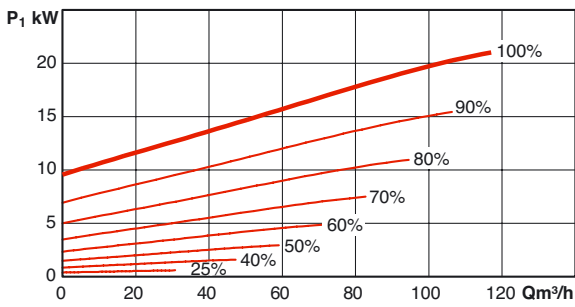
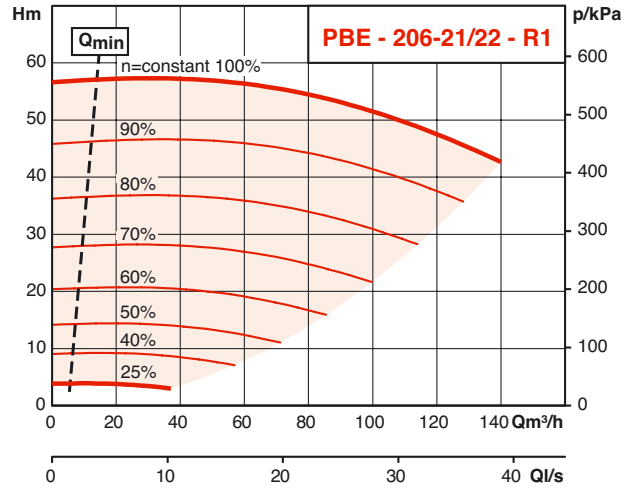
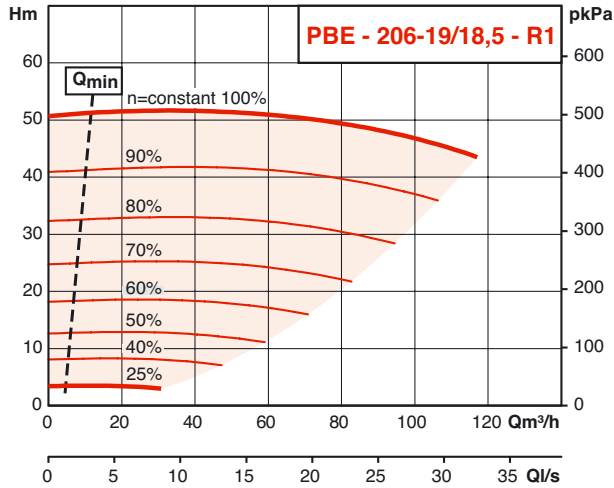



**PERFORMANCES HYDRAULIQUES**

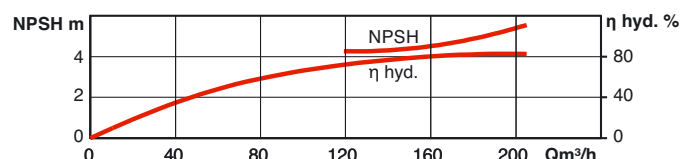
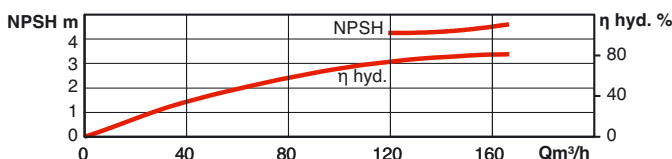
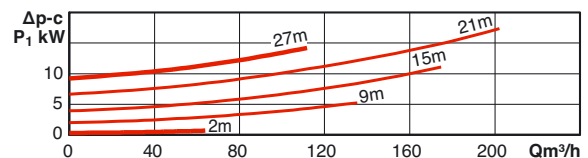
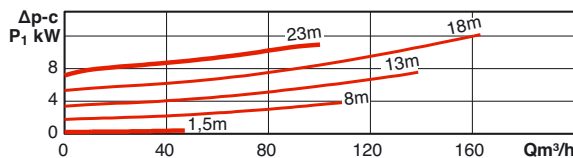
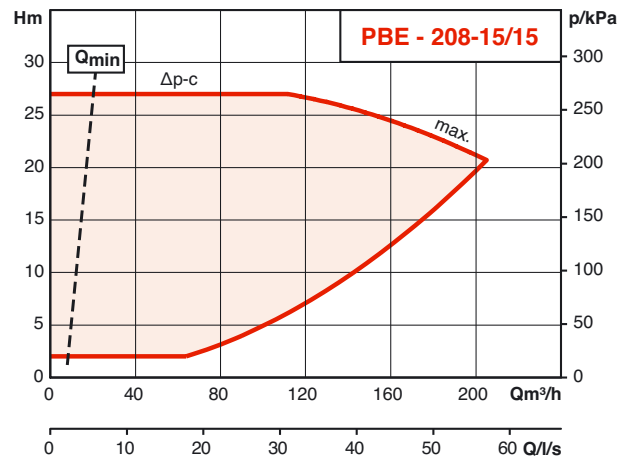
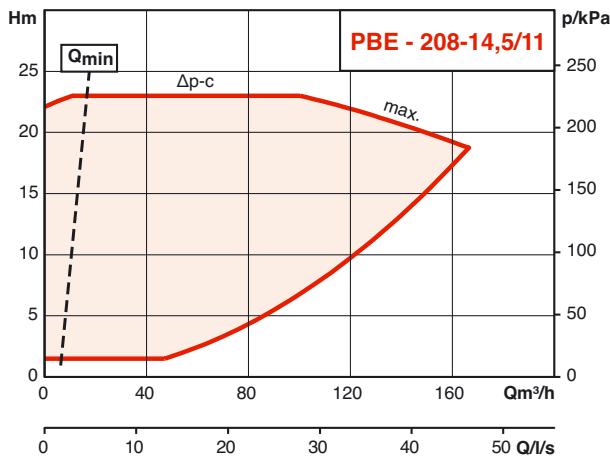
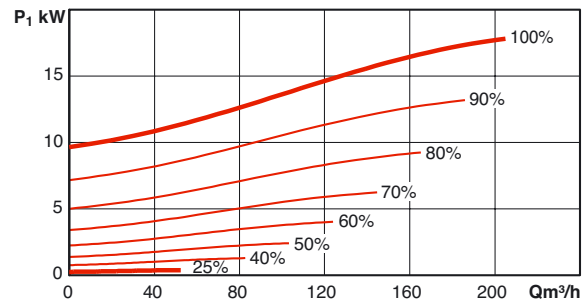
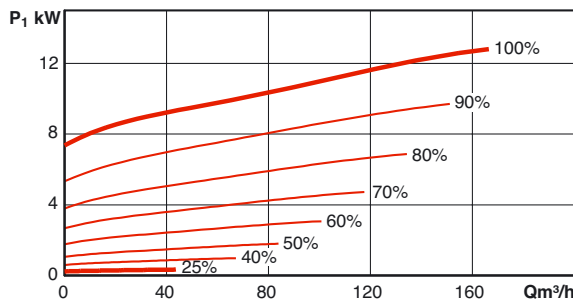
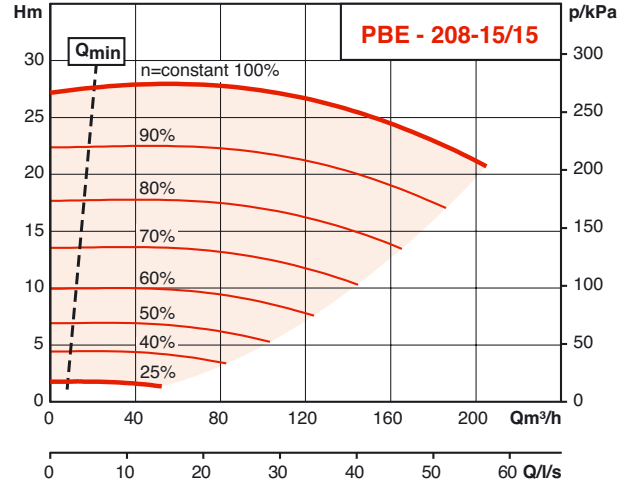
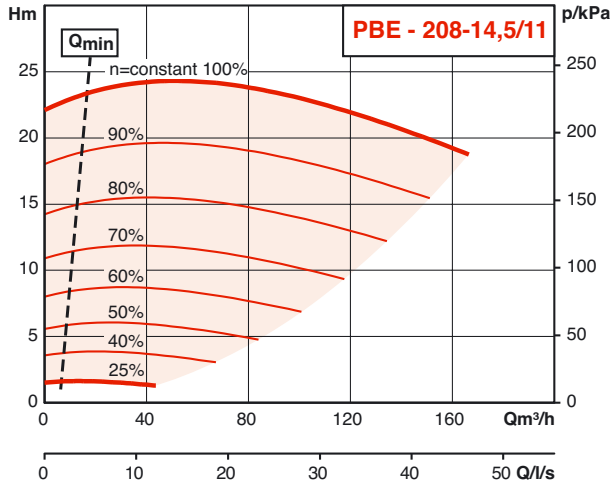

Génie climatique  
Pompes à rotor sec

# PBE

## PERFORMANCES HYDRAULIQUES

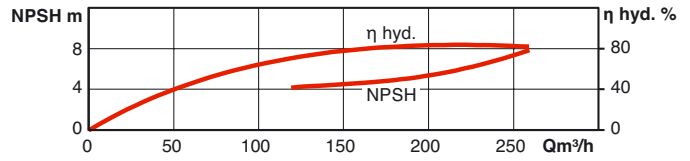
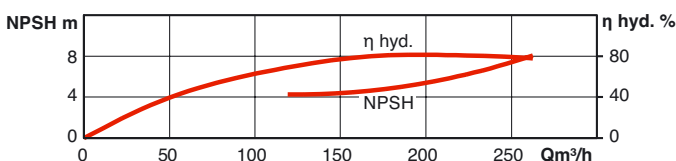
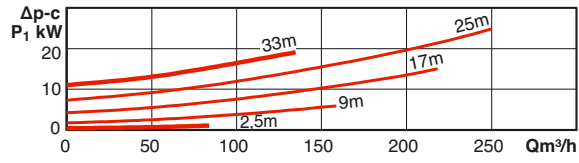
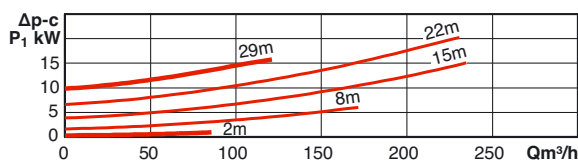
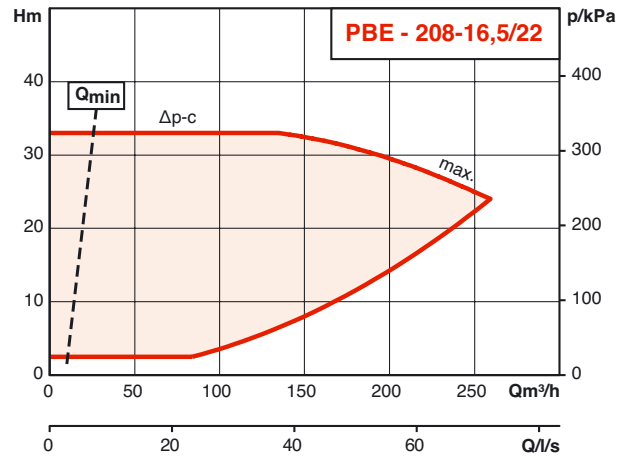
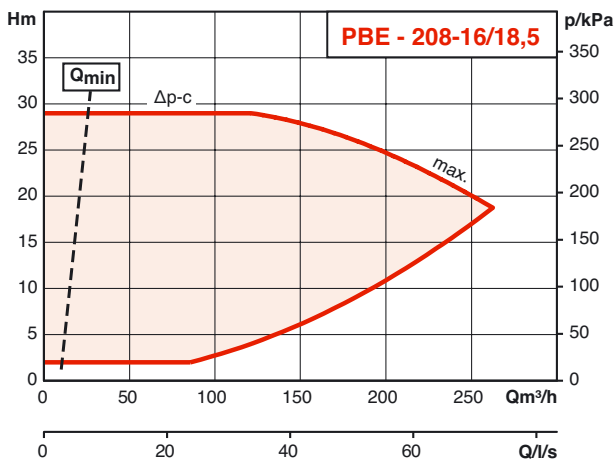
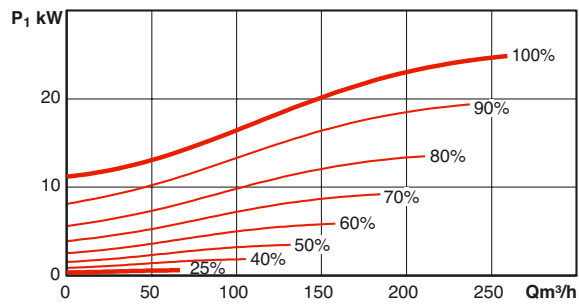
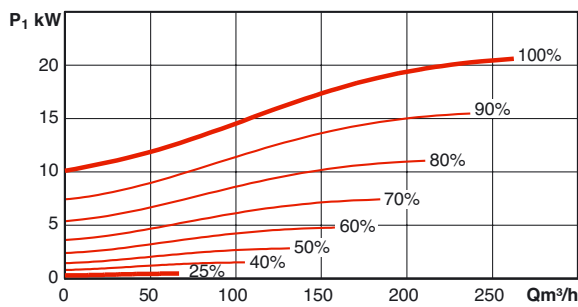
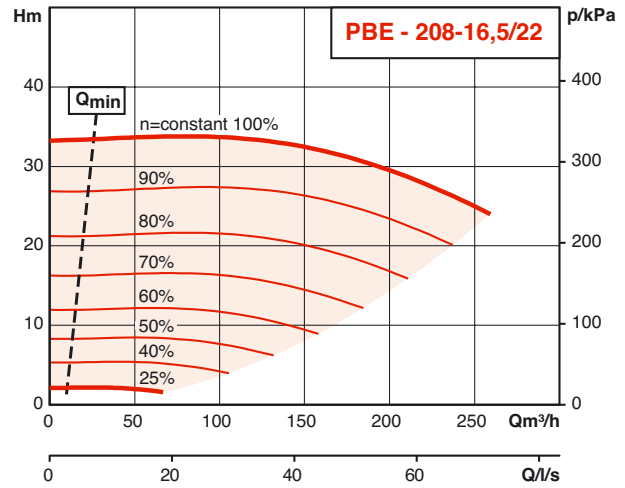
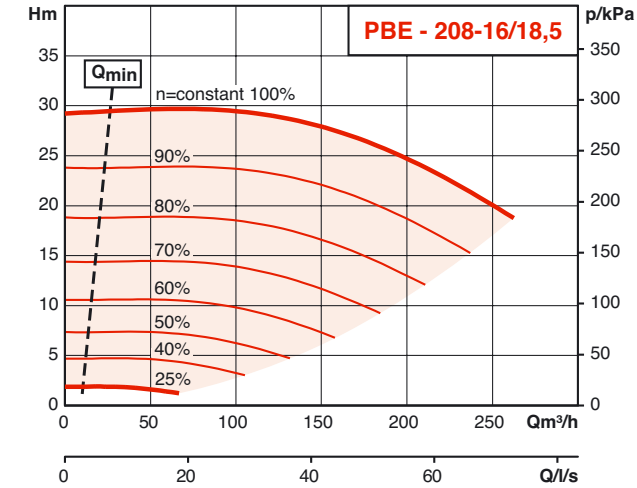

PERFORMANCES HYDRAULIQUES

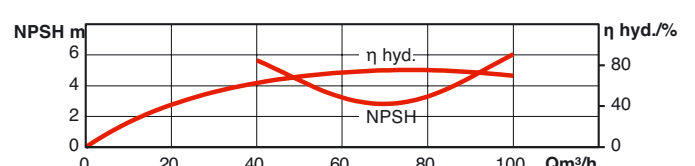
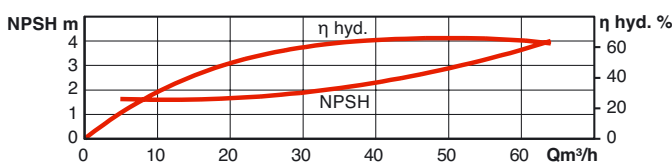
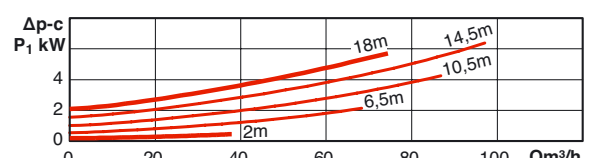
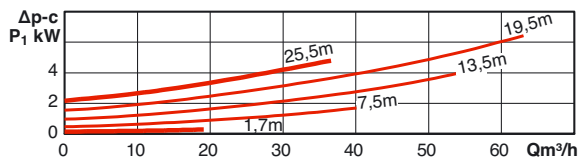
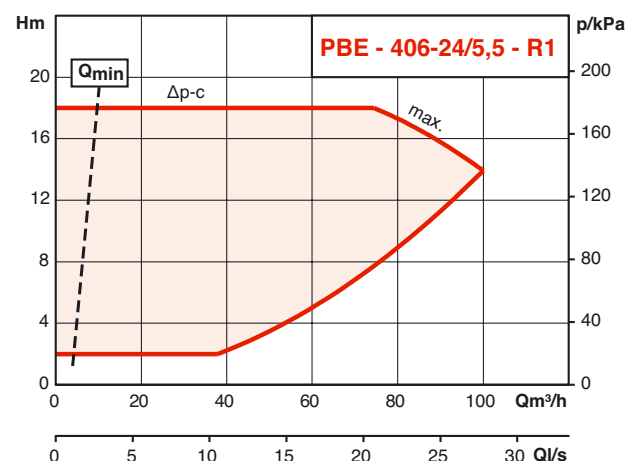
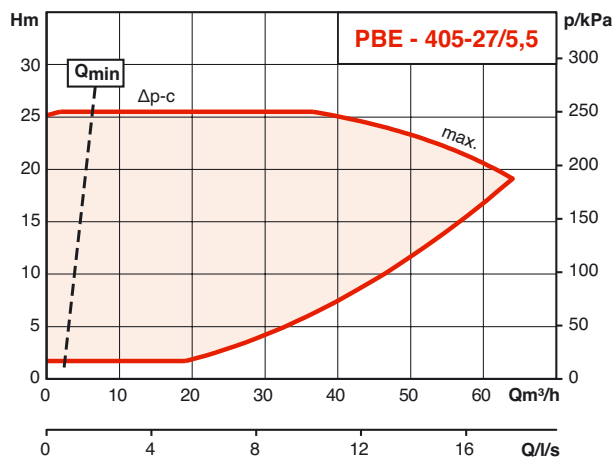
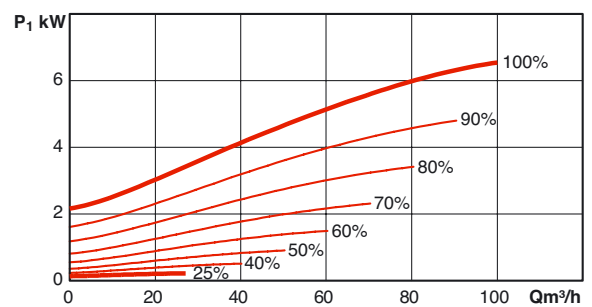
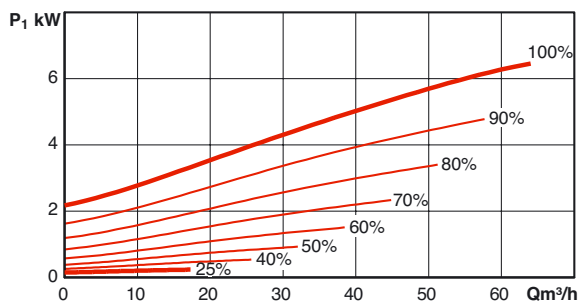
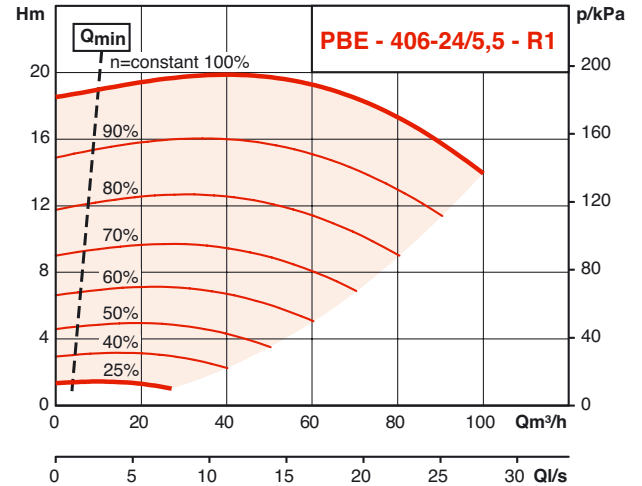
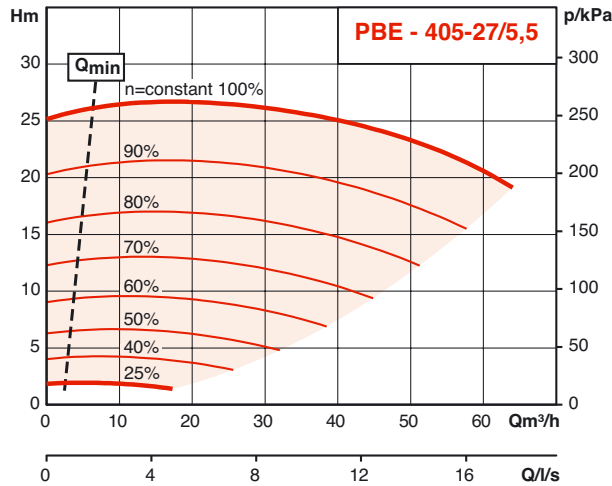

Génie climatique  
Pompes à rotor sec

# PBE

## PERFORMANCES HYDRAULIQUES

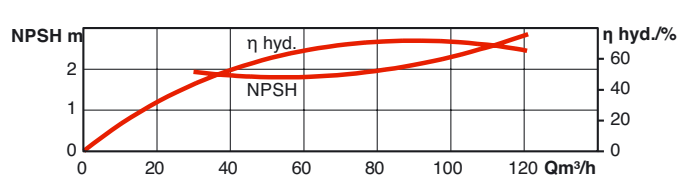
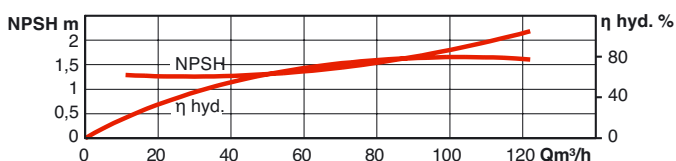
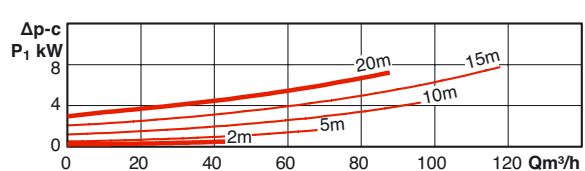
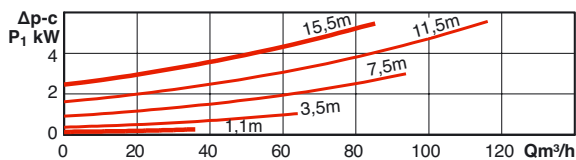
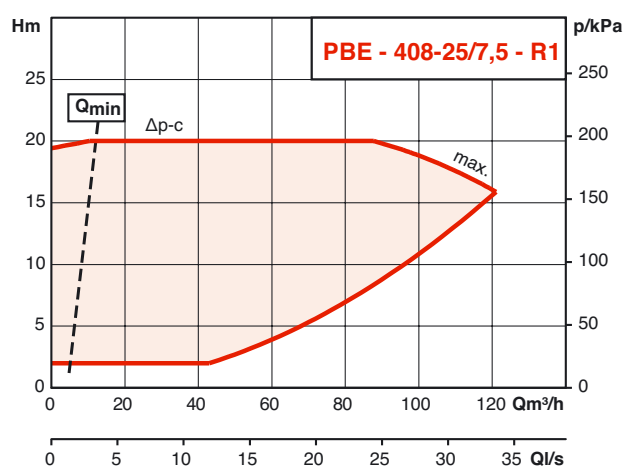
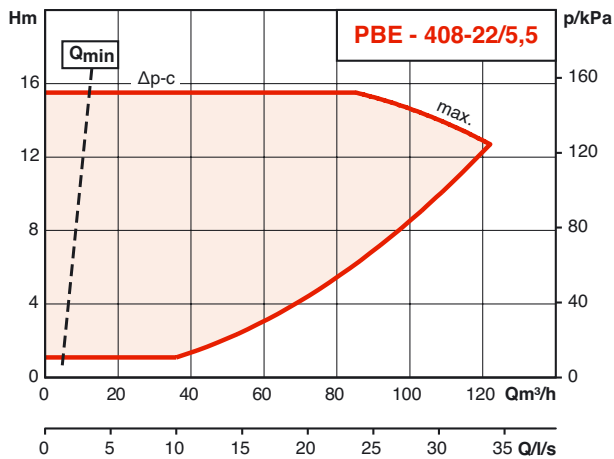
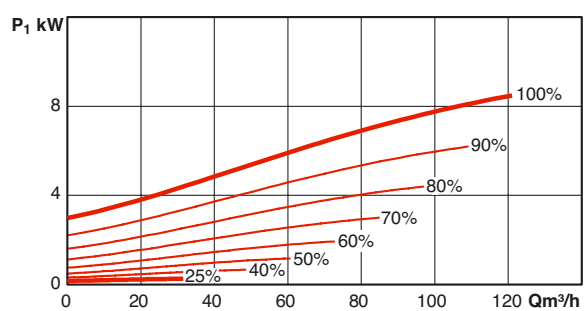
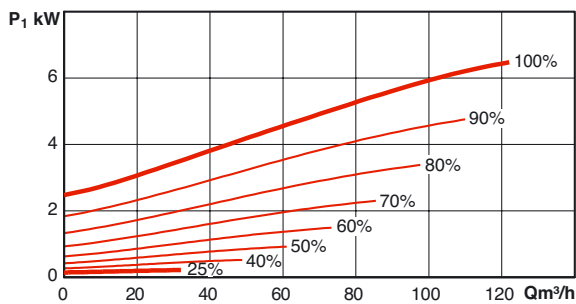
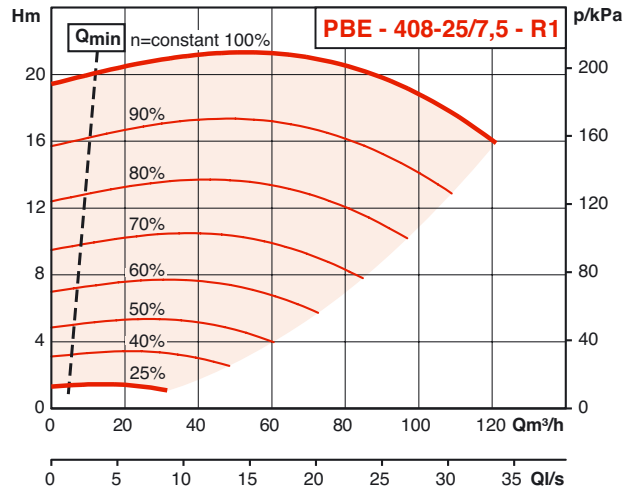
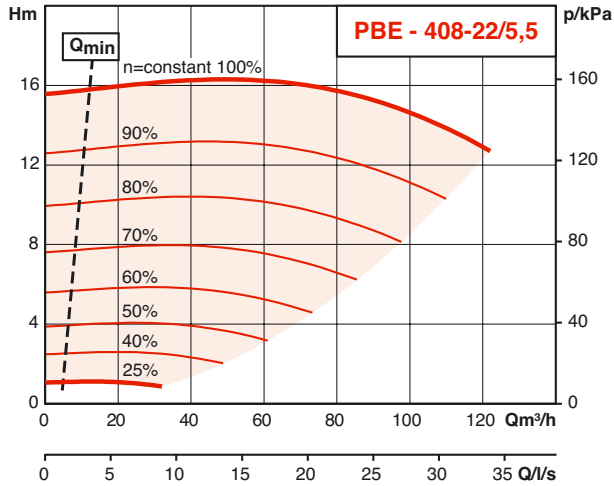

PERFORMANCES HYDRAULIQUES

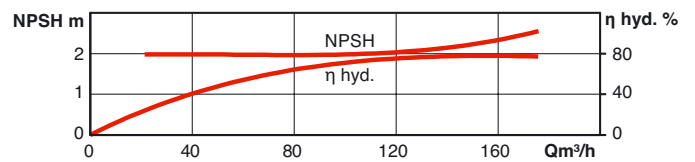
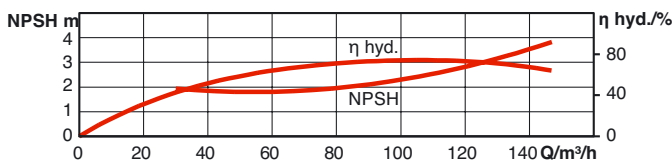
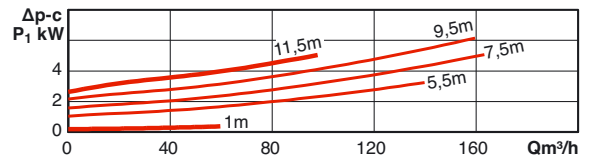
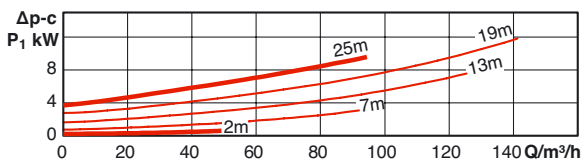
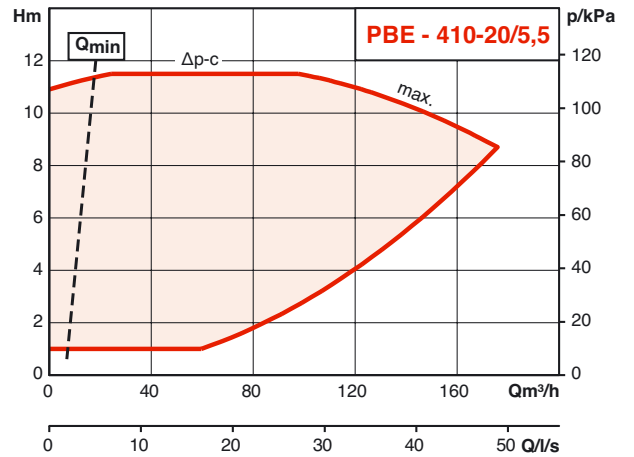
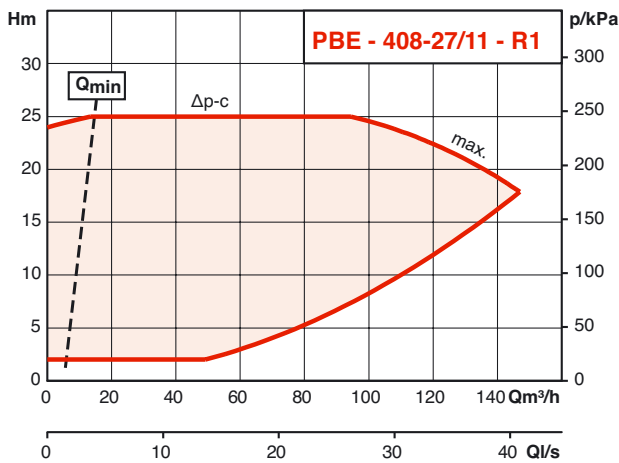
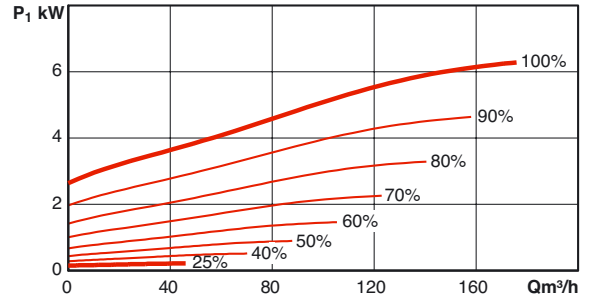
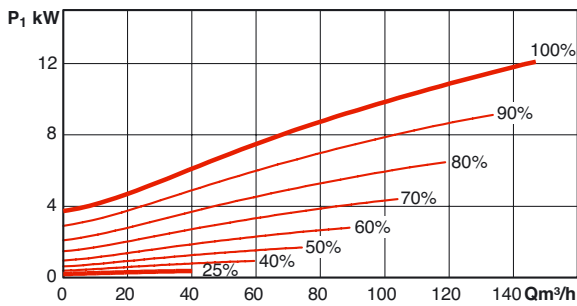
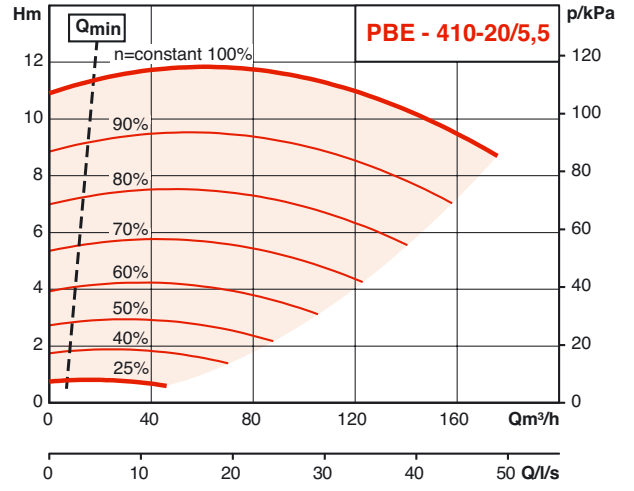
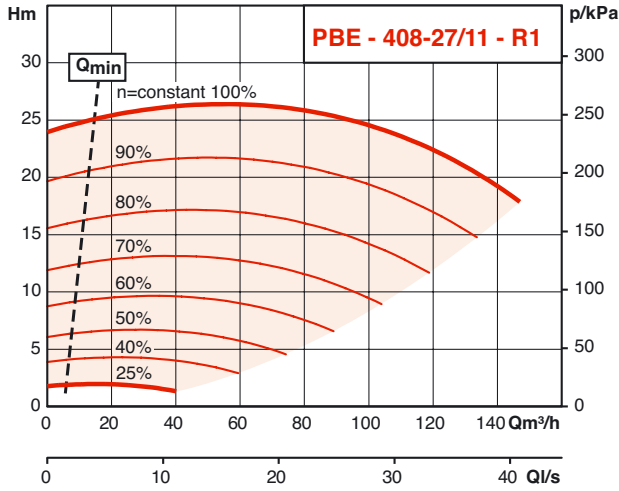

Génie climatique  
Pompes à rotor sec

# PBE

## PERFORMANCES HYDRAULIQUES

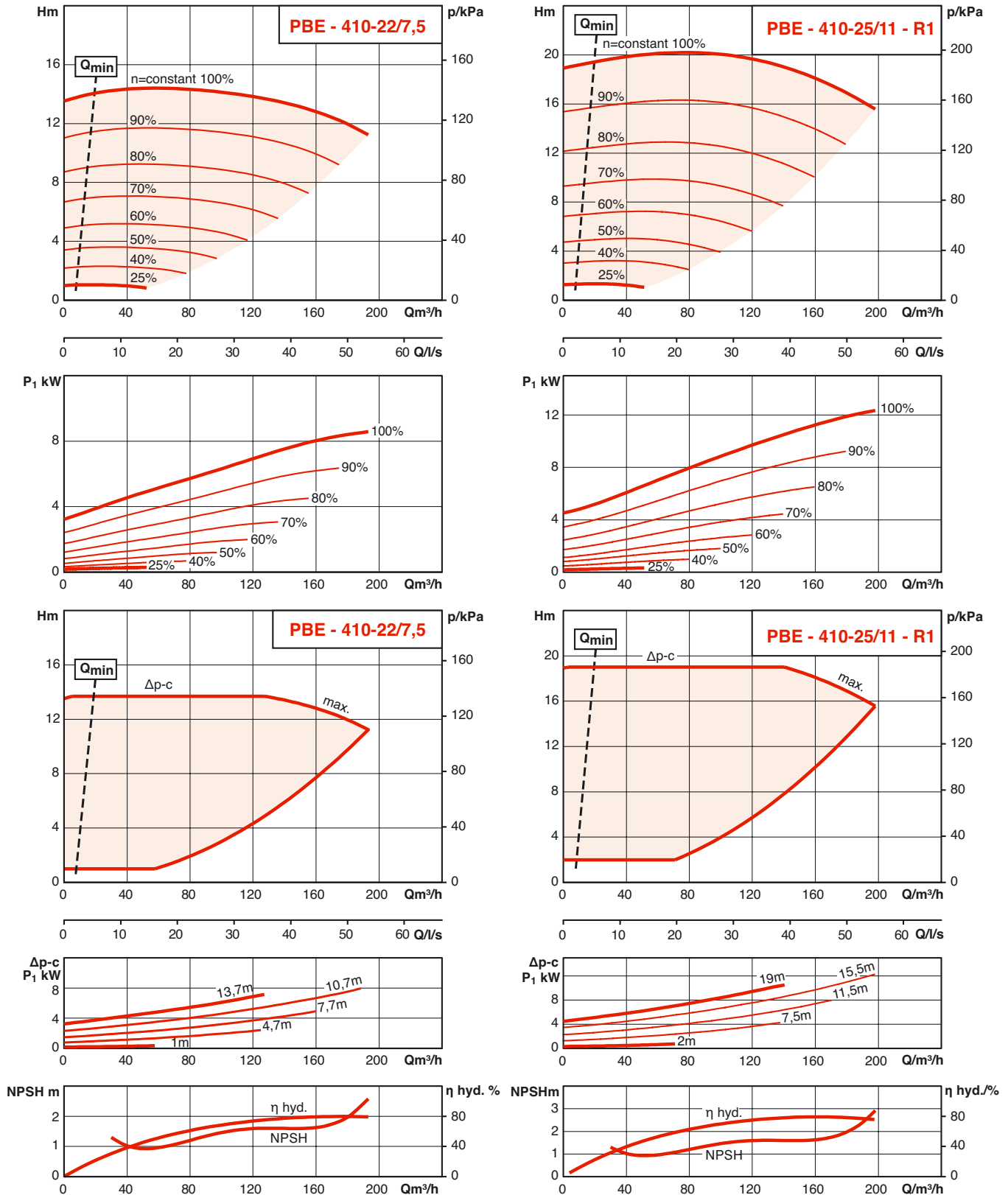

PERFORMANCES HYDRAULIQUES

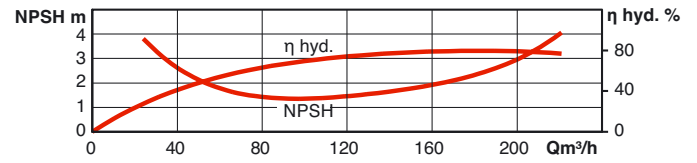
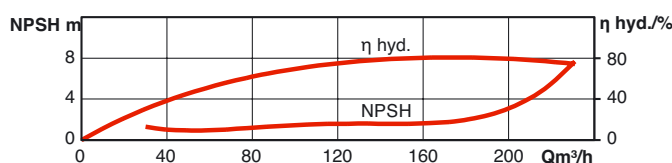
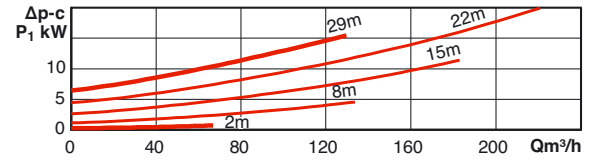
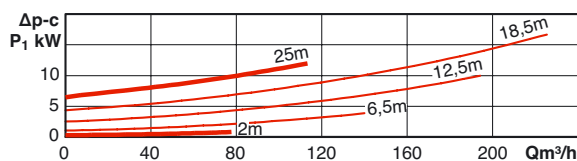
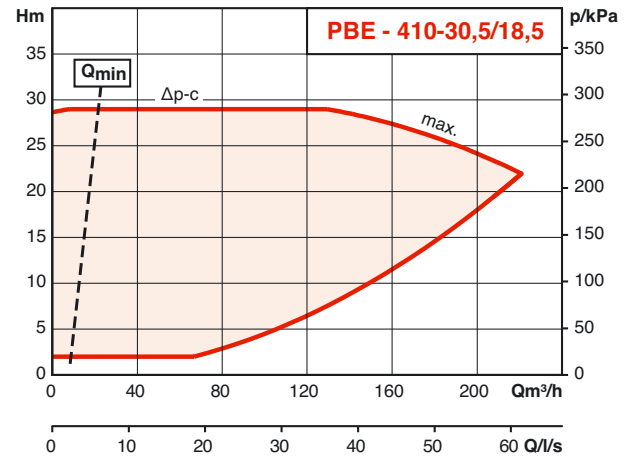
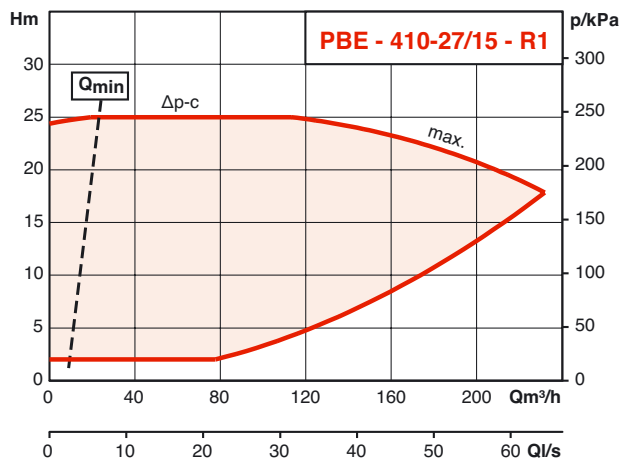
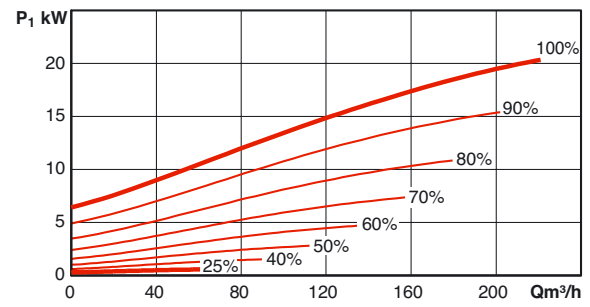
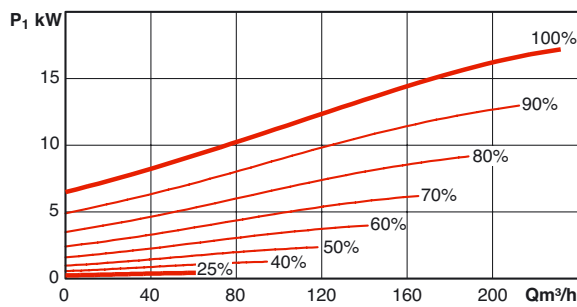
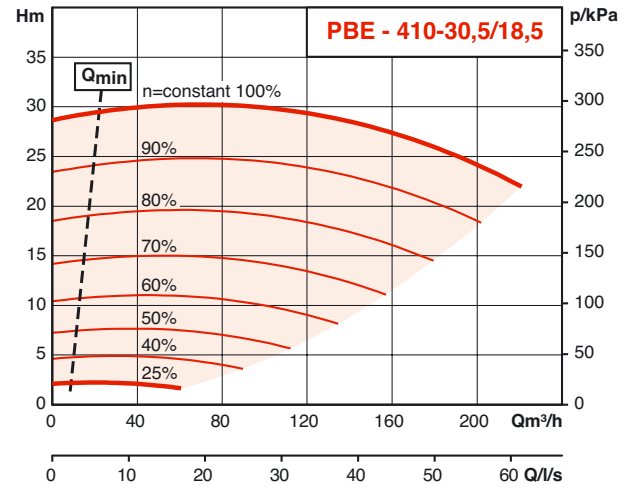
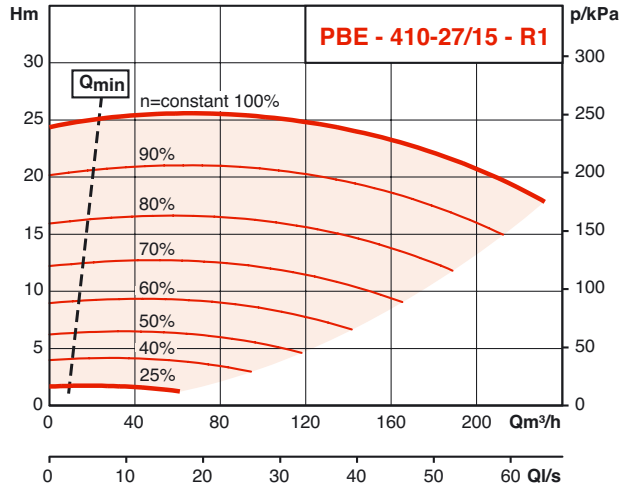

Génie climatique  
Pompes à rotor sec

# PBE

## PERFORMANCES HYDRAULIQUES

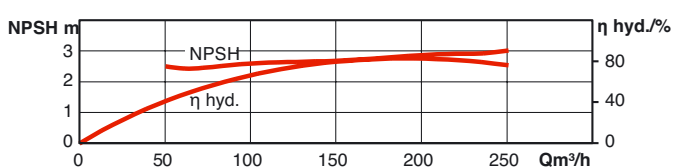
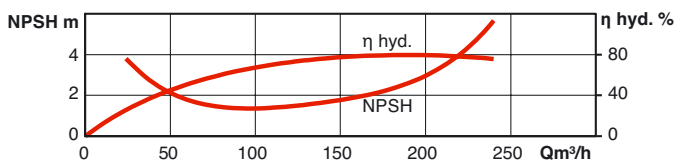
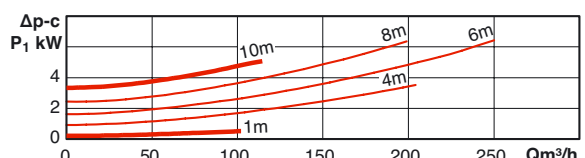
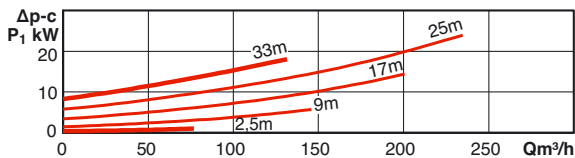
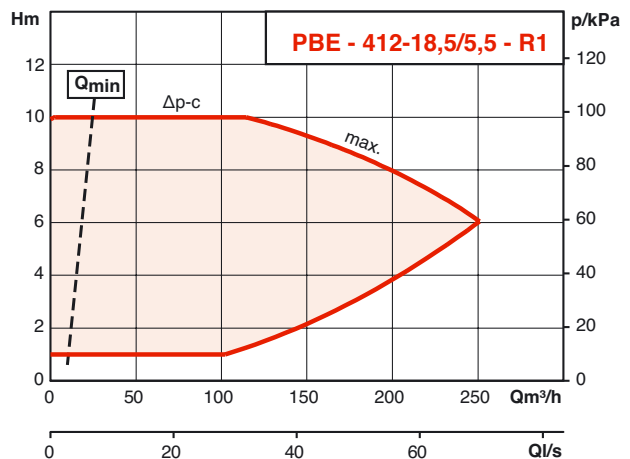
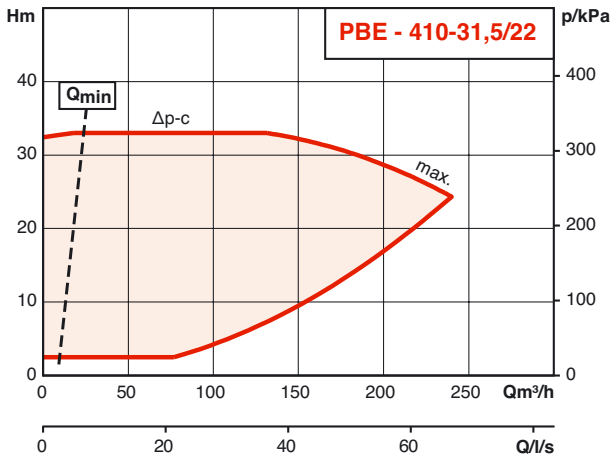
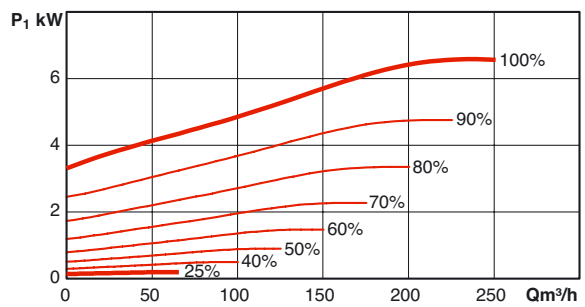
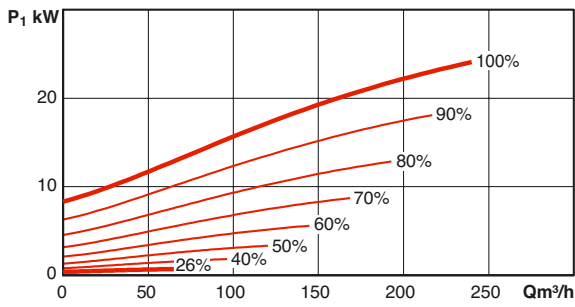
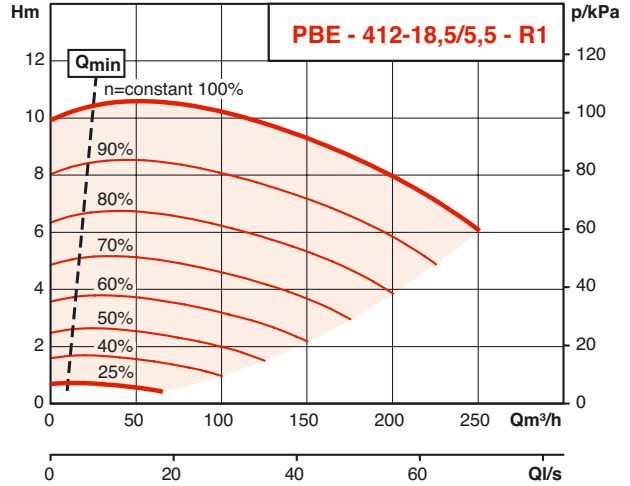
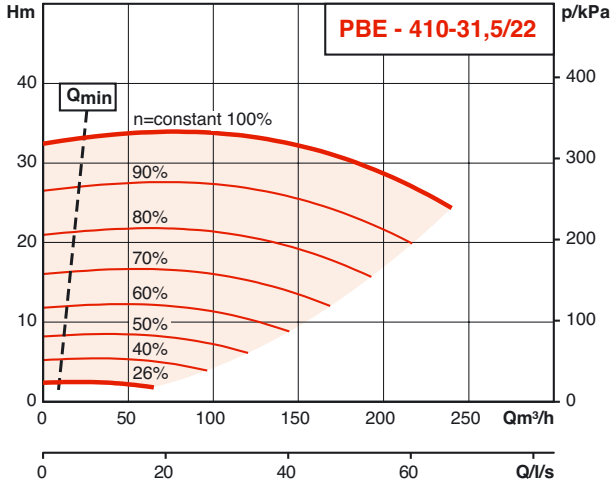



PERFORMANCES HYDRAULIQUES

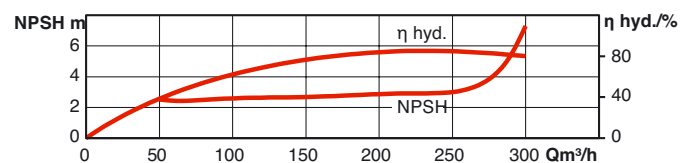
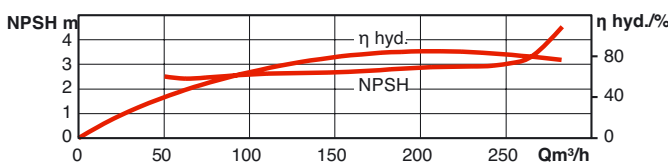
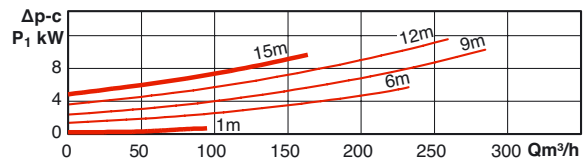
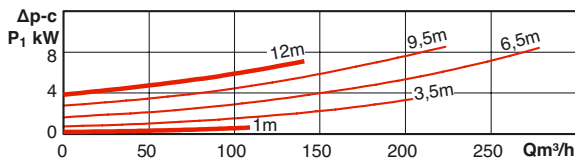
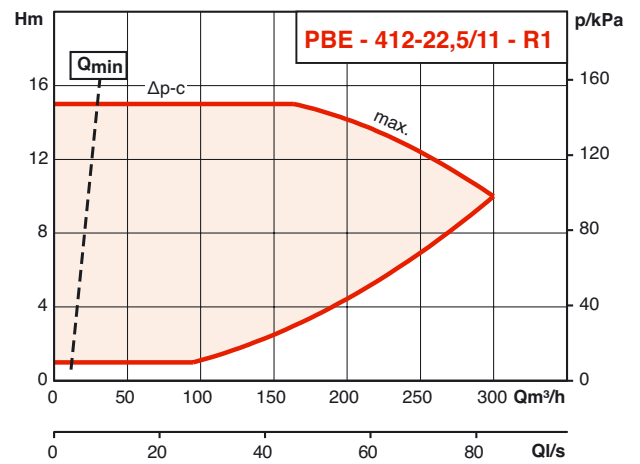
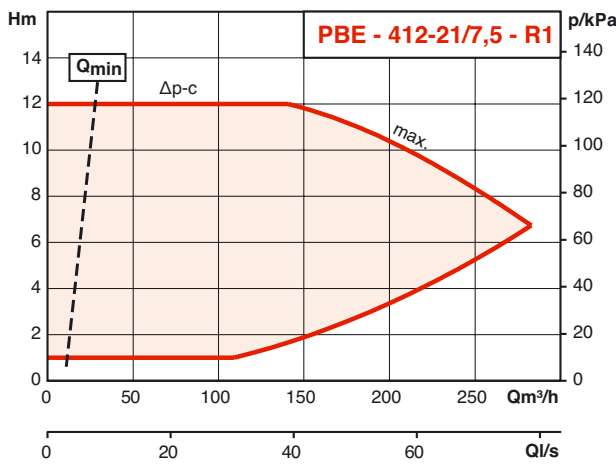
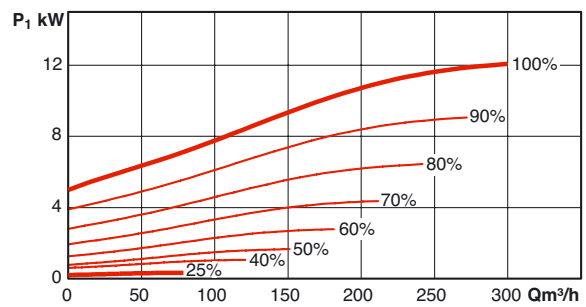
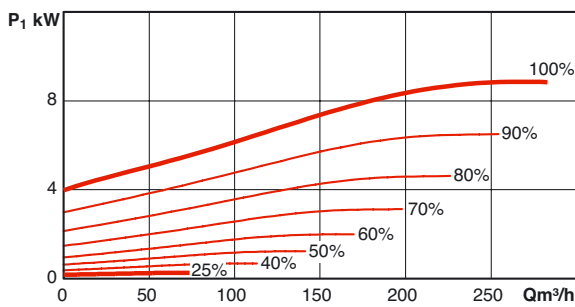
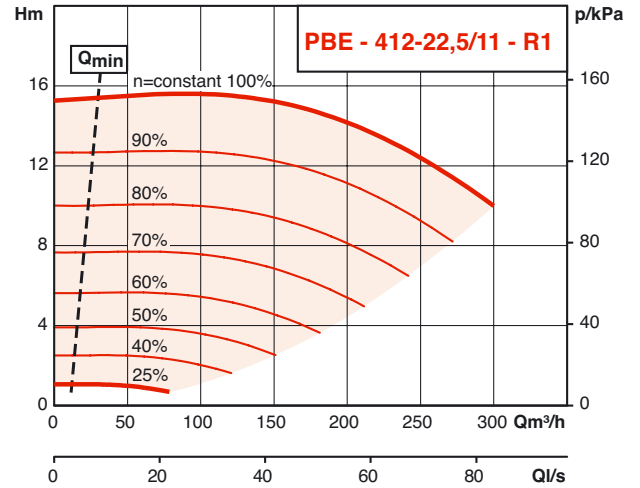
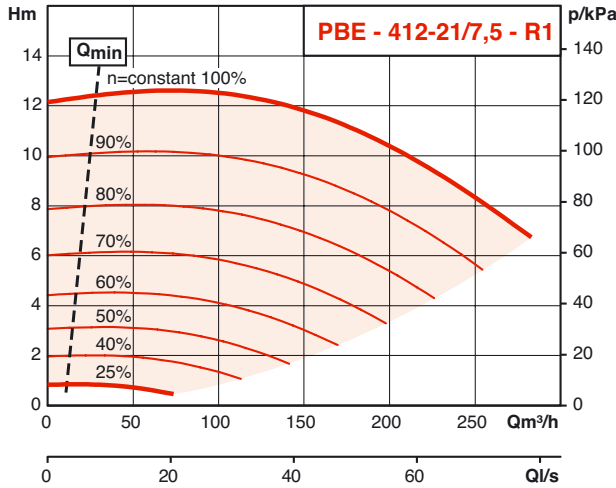

# PBE

## PERFORMANCES HYDRAULIQUES

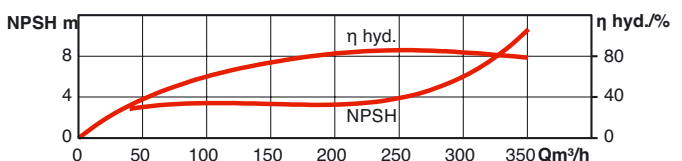
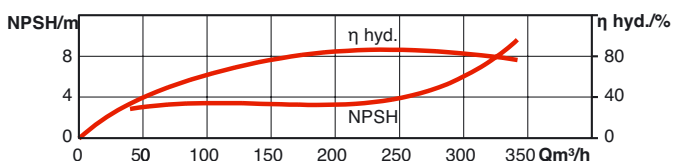
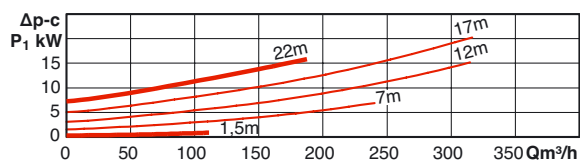
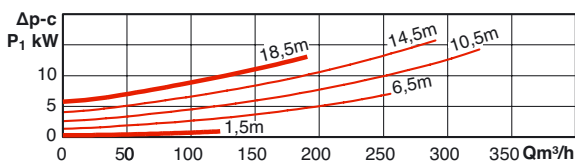
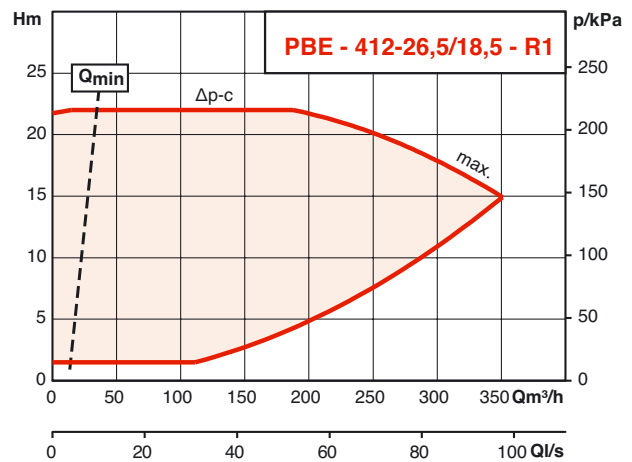
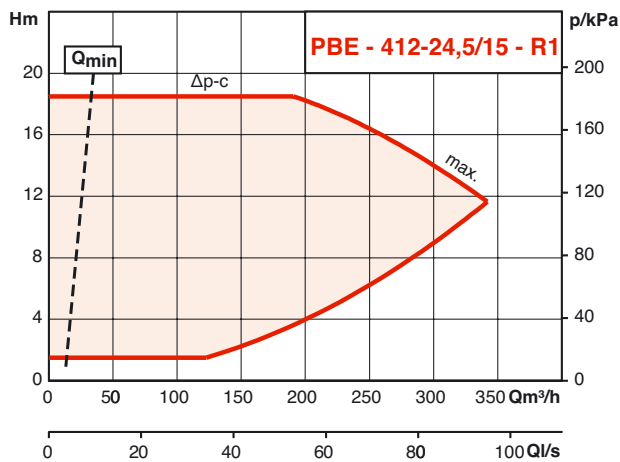
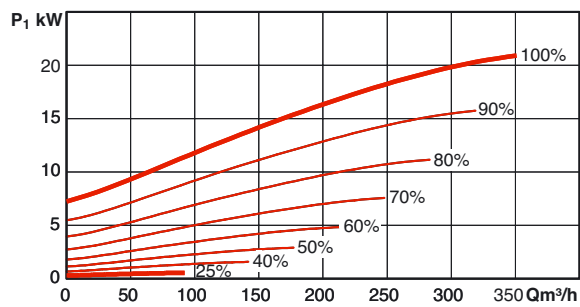
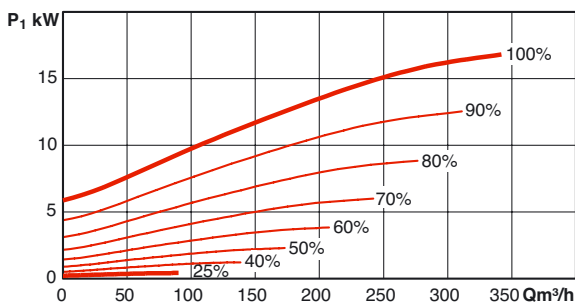
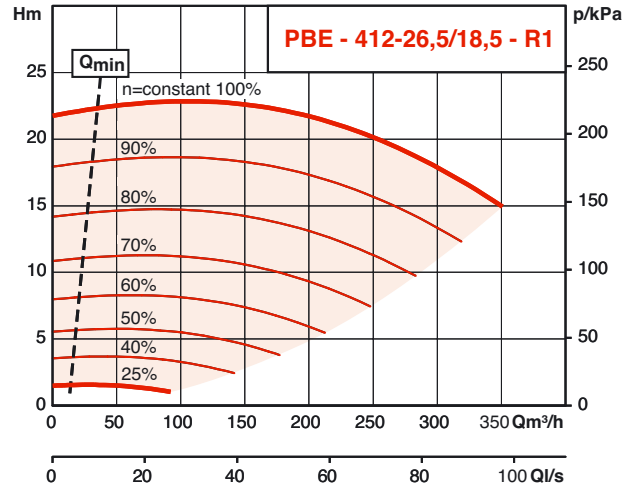
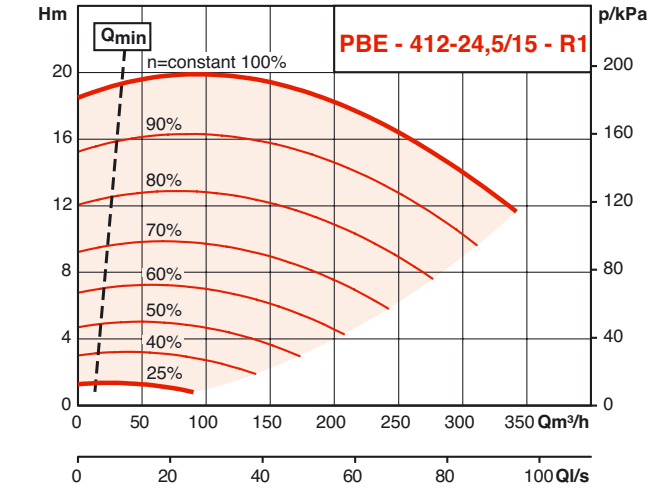

# PBE

## PERFORMANCES HYDRAULIQUES

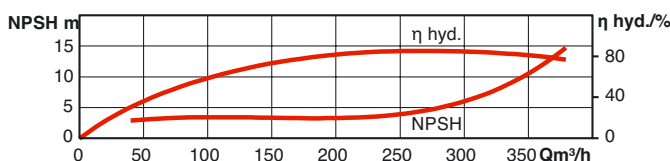
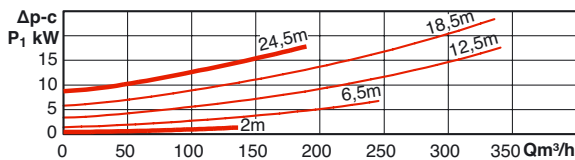
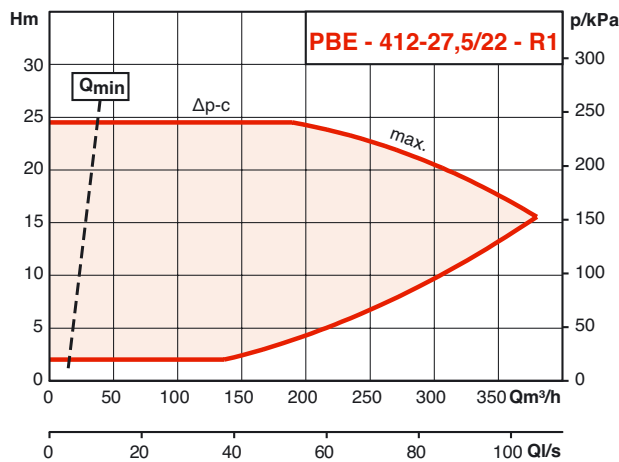
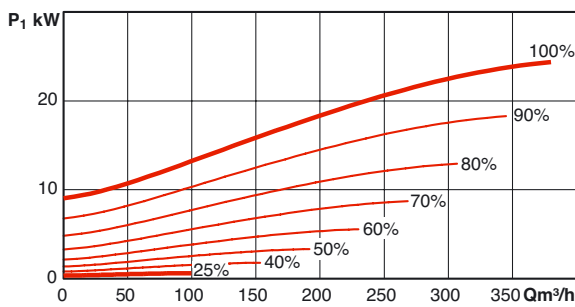
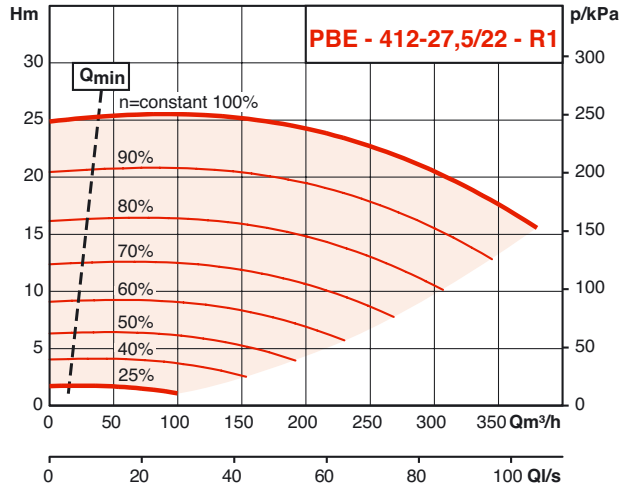

Génie climatique  
Pompes à rotor sec

# PBE

## DIMENSIONS – MOTEUR ≤ 4KW

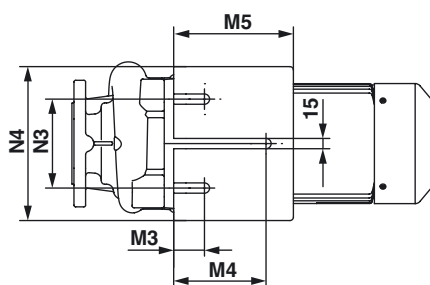
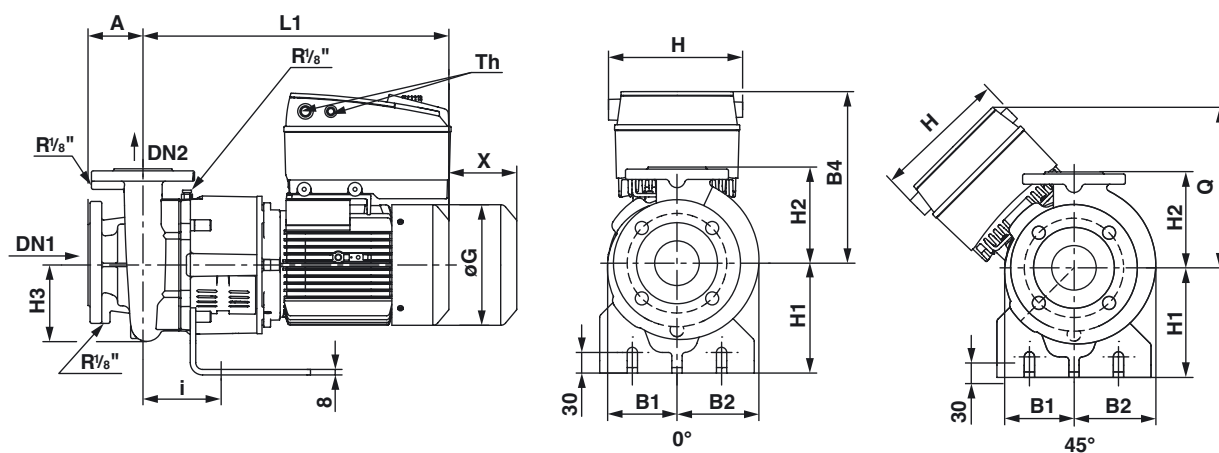

DNA	ØD	Øg	Øc	n x Ø
mm				
50	165	99	125	4 x 19
65	185	118	145	4 x 19
80	200	132	160	8 x 19

DNR	ØD	Øg	Øc	n x Ø
mm				
32	140	76	100	4 x 19
40	150	84	110	4 x 19
50	165	99	125	4 x 19
65	185	118	145	4 x 19

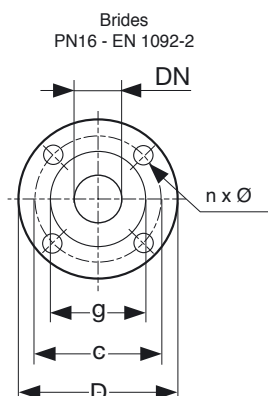

Référence article	Référence SAP	A	L1	X	ØG	Ø A1	H3	I	Th	H	H1	H2	B1	B2	B max	N3	N4	M3	M4	M5
											mm									
2126163	PBE203-14/2.2-R1	80	447	100	177	200	122	110	2xM12/1xM16/1xM20/1xM25	220	160	160	113	129	242	130	210	47,5	137,5	185
2126164	PBE203-15/3-R1	80	487,4	100	196	250	122	110	2xM12/1xM16/1xM20	220	160	160	113	129	242	130	210	47,5	137,5	185
2126165	PBE203-16/4-R1	80	504,4	100	220	250	122	110		220	160	160	113	129	242	130	210	47,5	137,5	185
2126169	PBE204-11/1.5-R1	80	435	105	177	200	111	114		220	160	140	101	119	220	130	225	45	135	175
2126170	PBE204-12/2.2-R1	80	445	105	177	200	111	114		220	160	140	101	119	220	130	225	45	135	175
2126171	PBE204-13/3-R1	80	487	105	196	250	111	114		220	160	140	101	119	220	130	225	45	135	175
2126172	PBE204-14/4-R1	80	504	105	220	250	111	114	2xM12/1xM16/1xM20/1xM25	220	160	140	101	119	220	130	225	45	135	175
2126179	PBE205-11/3-R1	100	494	110	196	250	124	121		220	160	160	111	133	244	130	225	45	135	175
2126180	PBE205-12/4-R1	100	511	110	220	250	124	121		220	160	160	111	133	244	130	225	45	135	175
2126189	PBE206-12/4-R1	100	516	120	220	250	155	126,5		220	160	180	123	151	274	130	225	45	135	175

\* Attention, H3 > H1. Le montage sur un support plan n'est pas possible, il est nécessaire d'ajouter une cale ou de monter la pompe sur un massif adapté.



# PBE

## DIMENSIONS – MOTEUR ≥ 5,5KW

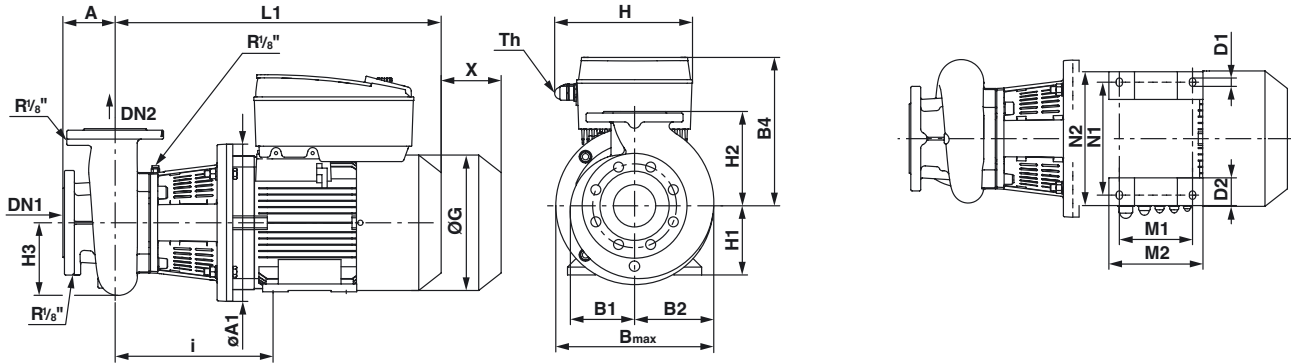

Brides  
PN16 - EN 1092-2

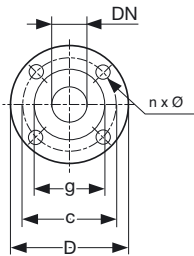

DNA	ØD	Øg	Øc	n x Ø
	mm	mm	mm	n x mm
50	165	99	125	4 x 19
65	185	118	145	4 x 19
80	200	132	160	8 x 19
100	220	156	180	8 x 19
125	250	184	210	8 x 19
150	285	211	240	8 x 23

DNA	ØD	Øg	Øc	n x Ø
	mm	mm	mm	n x mm
32	140	76	100	4 x 19
40	150	84	110	4 x 19
50	165	99	125	4 x 19
65	185	118	145	4 x 19
80	200	132	160	8 x 19
100	220	156	180	8 x 19
125	250	184	210	8 x 19

Code article	Désignation	A	L1	X	ØG	Ø A1	H3	I	Th	H	H1	H2	B1	B2	B <sub>max</sub>	B4	M1	M2	N1	N2	Ø	Ø				
		mm															mm	mm	mm	mm	mm	mm	mm	mm	mm	mm
2154341	PBE408-27/11-R1-IE4	125	727	120	350	350	199	369	2xM12/1xM16/1xM20/1xM40	320	160	280	192	218	410	463	210	305	254	310	15	65				
2144346	PBE410-20/5.5-R1	125	618	120	266	300	196	331	1xM12/2xM16/1xM20/1xM25	260	132	280	176	211	387	303	140	180	216	256	12	53				
2144347	PBE410-22/7.5-R1	125	618	120	266	325	196	331	1xM12/2xM16/1xM20/1xM25	260	132	280	176	211	387	303	140	180	216	256	12	53				
2154342	PBE410-25/11-R1-IE4	140	741	130	350	350	219	383	2xM12/1xM16/1xM20/1xM40	320	160	280	200	232	432	463	210	305	254	310	15	65				
2154343	PBE410-27/15-R1-IE4	140	741	130	350	350	219	383	2xM12/1xM16/1xM20/1xM40	320	160	280	200	232	432	463	210	305	254	310	15	65				
2154344	PBE410-30.5/18.5-R1-IE4	140	837	120	390	400	250	431	2xM12/1xM16/1xM20/1xM40	320	180	315	263	297	560	483	241	342	279	339	15	70				
2154345	PBE410-31.5/22-R1-IE4	140	837	120	390	400	250	431	2xM12/1xM16/1xM20/1xM40	320	180	315	263	297	560	483	279	342	279	339	15	70				
2126210	PBE412-18.5/5.5-R1	140	631	160	266	300	232	343	1xM12/2xM16/1xM20/1xM25	260	132	315	232	280	513	303	140	180	216	256	12	53				
2126211	PBE412-21/7.5-R1	140	631	160	266	325	232	343	1xM12/2xM16/1xM20/1xM25	260	132	315	232	280	513	303	140	180	216	256	12	53				
2154346	PBE412-22.5/11-R1-IE4	140	762	120	350	350	232	404	2xM12/1xM16/1xM20/1xM40	320	160	315	232	280	513	463	210	305	254	310	15	65				
2154347	PBE412-24.5/15-R1-IE4	140	781	120	350	350	250	435	2xM12/1xM16/1xM20/1xM40	320	160	355	252	294	546	463	210	305	254	310	15	65				
2154348	PBE412-26.5/18.5-R1-IE4	140	842	120	390	400	250	435	2xM12/1xM16/1xM20/1xM40	320	180	355	252	294	546	483	241	342	279	339	15	70				
2154349	PBE412-27.5/22-R1-IE4	140	842	120	390	400	250	435	2xM12/1xM16/1xM20/1xM40	320	180	355	252	294	546	483	279	342	279	339	15	70				

\* Attention, H3 > H1. Le montage sur un support plan n'est pas possible, il est nécessaire d'ajouter une cale ou de monter la pompe sur un massif adapté.